

Kingbright

Optoelectronic Components



High Brightness PLCC LEDs	2
High Brightness Ceramic LEDs	5
High Brightness LEDs	8





1W /2W /3W

PART NUMBER	MATERIAL	λ_D (nm)	LENS TYPE	IF (mA)	Pd (W)	Φ_v (lm)	VIEWING ANGLE	DIMENSION
KAD1-1010SE28Z1S	AlGaInP	625	water clear	350	1	30	20°	10mm x 10mm (X Power) Units : mm(inch) Tolerance : ±0.25(0.01)
KAD1-1010SY28Z1S	AlGaInP	588	water clear	350	1	35	20°	
KA-8070SE28Z1S	AlGaInP	625	water clear	350	1	25	120°	14.5mm x 7mm x 1.8mm Units : mm(inch) Tolerance : ±0.25(0.01)
KA-8070SY28Z1S	AlGaInP	588	water clear	350	1	30	120°	
KA-8070ZG10Z1S	AlGaInN	530	water clear	350	1	55	120°	
KA-8070QB10Z1S	AlGaInN	458	water clear	350	1	15	120°	
KA-8070SE9Z1S/2	AlGaInP	623	water clear	500	2	39	120°	
KA-8070SY9Z1S/2	AlGaInP	591	water clear	500	2	31	120°	
KA-8070QB11Z1S/3	AlGaInN	460	water clear	700	3	24	120°	
KADS-8070SE28Z1S	AlGaInP	625	water clear	350	1	30	90°	14.5mm x 7mm x 4.6mm Units : mm(inch) Tolerance : ±0.25(0.01)
KADS-8070SY28Z1S	AlGaInP	588	water clear	350	1	28	90°	
KADS-8070ZG10Z1S	AlGaInN	530	water clear	350	1	62	90°	
KADS-8070QB10Z1S	AlGaInN	458	water clear	350	1	17	90°	
KADS-8070SE9Z1S/2	AlGaInP	623	water clear	500	2	43	90°	
KADS-8070SY9Z1S/2	AlGaInP	591	water clear	500	2	37	90°	
KADS-8070QB11Z1S/3	AlGaInN	460	water clear	700	3	27	90°	

1W /2W /3W

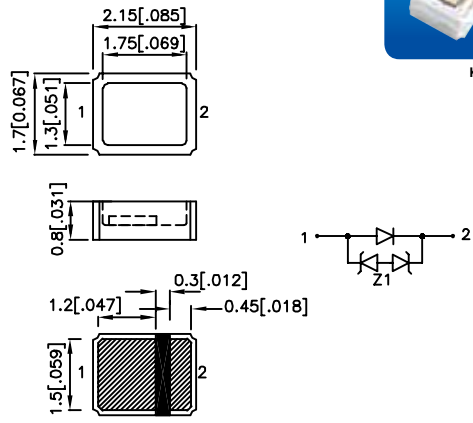
PART NUMBER	MATERIAL	λ_D (nm)	LENS TYPE	IF (mA)	Pd (W)		VIEWING ANGLE	DIMENSION
					TYP.	TYP.		
KA-8080SE28Z1S	AlGaInP	625	water clear	350	1	25	120°	<p>14.5mm x 8mm x 2.5mm</p> <p>Units : mm(inch) Tolerance : ±0.25(0.01)</p>
KA-8080SY28Z1S	AlGaInP	588	water clear	350	1	25	120°	
KA-8080ZG10Z1S	AlGaInN	530	water clear	350	1	60	120°	
KA-8080QB10Z1S	AlGaInN	458	water clear	350	1	14	120°	
KA-8080SE9Z1S/2	AlGaInP	623	water clear	500	2	45	120°	
KA-8080SY9Z1S/2	AlGaInP	591	water clear	500	2	50	120°	
KA-8080QB11Z1S/3	AlGaInN	460	water clear	700	3	28	120°	
KADG1-8080SE28Z1S	AlGaInP	625	water clear	350	1	28	100°	<p>14.5mm x 8mm x 4.7mm</p> <p>Units : mm(inch) Tolerance : ±0.25(0.01)</p>
KADG1-8080SY28Z1S	AlGaInP	588	water clear	350	1	28	100°	
KADG1-8080ZG10Z1S	AlGaInN	530	water clear	350	1	65	100°	
KADG1-8080QB10Z1S	AlGaInN	458	water clear	350	1	17	100°	
KADG1-8080SE9Z1S/2	AlGaInP	623	water clear	500	2	50	100°	
KADG1-8080SY9Z1S/2	AlGaInP	591	water clear	500	2	55	100°	
KADG1-8080QB11Z1S/3	AlGaInN	460	water clear	700	3	30	100°	

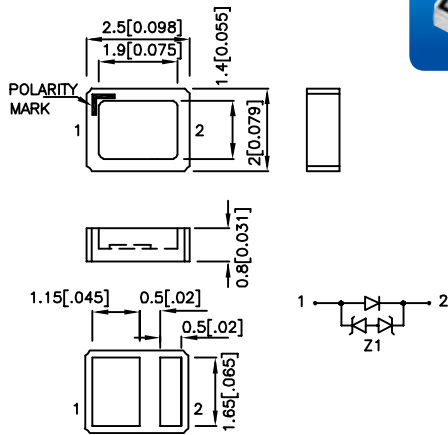
0.5W /1W

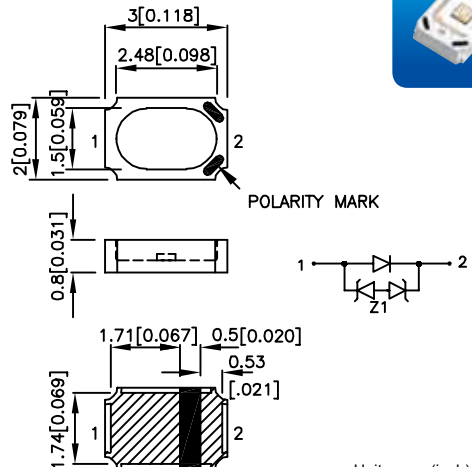
PART NUMBER	MATERIAL	λ_D (nm)	LENS TYPE	IF (mA)	Pd (W)		VIEWING ANGLE	DIMENSION
					TYP.	TYP.		
KT-2117SEL1Z1S-VFS	AlGaInP	618	water clear	140	0.5	9	120°	2.15mm x 1.7mm x 0.8mm  KT-2117  Units : mm(inch) Tolerance : ±0.25(0.01)
KT-2117SYL1Z1S-VFS	AlGaInP	590	water clear	140	0.5	7	120°	
KT-2117ZG25Z1S-VFS	InGaN	525	water clear	150	0.5	22	120°	
KT-2117QB25Z1S-VFS	InGaN	450	water clear	150	0.5	4.3	120°	
KT-2117SE9Z1S-VFS	AlGaInP	623	water clear	350	1	16	120°	
KT-2117SY9Z1S-VFS	AlGaInP	591	water clear	350	1	16	120°	
KT-2117ZG10Z1S-VFS	AlGaInN	530	water clear	350	1	42	120°	
KT-2117QB10Z1S-VFS	AlGaInN	458	water clear	350	1	12	120°	
KT-2520SEL1Z1S	AlGaInP	618	water clear	150	0.5	8.5	130°	2.5mm x 2.0mm x 0.8mm  KT-2520  Units : mm(inch) Tolerance : ±0.25(0.01)
KT-2520SYL1Z1S	AlGaInP	590	water clear	150	0.5	7	130°	
KT-2520ZG25Z1S	InGaN	525	water clear	150	0.5	21	120°	
KT-2520QB25Z1S	InGaN	450	water clear	150	0.5	4.3	120°	
KT-2520SE9Z1S	AlGaInP	623	water clear	350	1	18	130°	
KT-2520SY9Z1S	AlGaInP	591	water clear	350	1	16	130°	
KT-2520ZG10Z1S	AlGaInN	530	water clear	350	1	45	120°	
KT-2520QB10Z1S	AlGaInN	458	water clear	350	1	13	120°	
KT-3020SEL1Z1S	AlGaInP	618	water clear	150	0.5	9	120°	3.0mm x 2.0mm x 0.8mm  KT-3020  Units : mm(inch) Tolerance : 0.25(0.01)
KT-3020SYL1Z1S	AlGaInP	590	water clear	150	0.5	9	120°	
KT-3020ZG25Z1S	InGaN	525	water clear	150	0.5	21	120°	
KT-3020QB25Z1S	InGaN	450	water clear	150	0.5	5	120°	

0.5W /1W

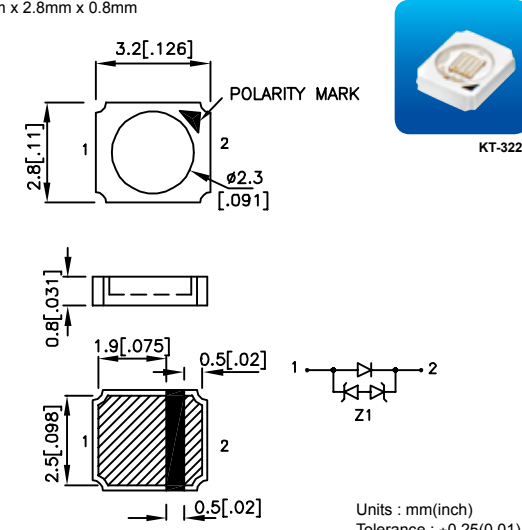
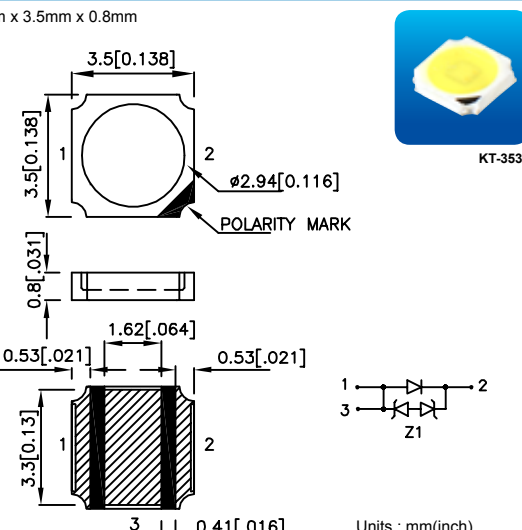
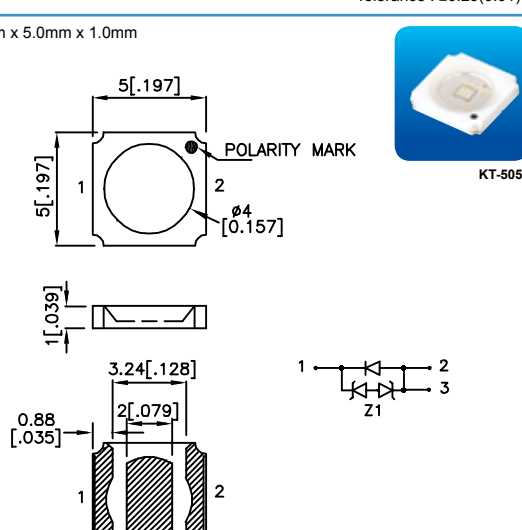
PART NUMBER	MATERIAL	λ_D (nm)	LENS TYPE	IF (mA)	Pd (W)		VIEWING ANGLE		DIMENSION
					TYP.	TYP.	TYP.	TYP.	
KT-3228SEL1Z1S	AlGaInP	618	water clear	150	0.5	9	120°	3.2mm x 2.8mm x 0.8mm  <p>Units : mm(inch) Tolerance : ±0.25(0.01)</p>	
KT-3228SYL1Z1S	AlGaInP	590	water clear	150	0.5	10	120°		
KT-3228ZG25Z1S	InGaN	525	water clear	150	0.5	23	120°		
KT-3228QB25Z1S	InGaN	450	water clear	150	0.5	4.3	120°		
KT-3228SE9Z1S	AlGaInP	623	water clear	350	1	18	120°		
KT-3228SY9Z1S	AlGaInP	591	water clear	350	1	14	120°		
KT-3228ZG10Z1S	AlGaInN	530	water clear	350	1	50	120°		
KT-3228QB10Z1S	AlGaInN	458	water clear	350	1	13	120°		
KT-3535SEL1Z1S	AlGaInP	618	water clear	150	0.5	9	120°	3.5mm x 3.5mm x 0.8mm  <p>Units : mm(inch) Tolerance : ±0.25(0.01)</p>	
KT-3535SYL1Z1S	AlGaInP	590	water clear	150	0.5	9	120°		
KT-3535ZG25Z1S	InGaN	525	water clear	150	0.5	22	120°		
KT-3535QB25Z1S	InGaN	450	water clear	150	0.5	4.3	120°		
KT-3535SE9Z1S	AlGaInP	623	water clear	350	1	16	120°		
KT-3535SY9Z1S	AlGaInP	591	water clear	350	1	17	120°		
KT-3535ZG10Z1S	AlGaInN	530	water clear	350	1	55	120°		
KT-3535QB10Z1S	AlGaInN	458	water clear	350	1	13	120°		
KT-5050SEL1Z1S	AlGaInP	618	water clear	150	0.5	9.5	120°	5.0mm x 5.0mm x 1.0mm  <p>Units : mm(inch) Tolerance : ±0.25(0.01)</p>	
KT-5050SYL1Z1S	AlGaInP	590	water clear	150	0.5	8.5	120°		
KT-5050ZG25Z1S	InGaN	525	water clear	150	0.5	25	120°		
KT-5050QB25Z1S	InGaN	450	water clear	150	0.5	5.2	120°		
KT-5050SE9Z1S	AlGaInP	623	water clear	350	1	24	120°		
KT-5050SY9Z1S	AlGaInP	591	water clear	350	1	25	120°		
KT-5050ZG10Z1S	AlGaInN	530	water clear	350	1	55	120°		
KT-5050QB10Z1S	AlGaInN	458	water clear	350	1	15	120°		

0.5W /1W /2W

PART NUMBER	MATERIAL	λ_D (nm)	LENS TYPE	IF (mA)	Pd (W)	Φ_v (lm)	VIEWING ANGLE	DIMENSION
					TYP.	TYP.		
KT-5051SEL1Z1S	AlGaInP	618	water clear	150	0.5	9.5	120°	<p>5.0mm x 5.0mm x 1.0mm</p> <p>CATHODE MARK</p> <p>2 3 4 5 Z1 Slug</p> <p>1,3,4,6 NO CONNECTION</p> <p>Units : mm(inch) Tolerance : ±0.25(0.01)</p>
KT-5051SYL1Z1S	AlGaInP	590	water clear	150	0.5	8.5	120°	
KT-5051ZG25Z1S	InGaN	525	water clear	150	0.5	25	120°	
KT-5051QB25Z1S	InGaN	450	water clear	150	0.5	5.2	120°	
KT-5051SE9Z1S	AlGaInP	623	water clear	350	1	24	120°	
KT-5051SY9Z1S	AlGaInP	591	water clear	350	1	25	120°	
KT-5051ZG10Z1S	AlGaInN	530	water clear	350	1	55	120°	
KT-5051QB10Z1S	AlGaInN	458	water clear	350	1	15	120°	
KTDG-8080SE9Z1S/2	AlGaInP	623	water clear	500	2	50	90°	<p>8.0mm x 8.0mm x 4.2mm</p> <p>POLARITY MARK</p> <p>1 2 Z1 PAD 3 NO CONNECTION</p> <p>Units : mm(inch) Tolerance : ±0.25(0.01)</p>
KTDG-8080SY9Z1S/2	AlGaInP	591	water clear	500	2	53	90°	
KTDG-8080ZG10Z1S/2	AlGaInN	530	water clear	500	2	70	90°	
KTDG-8080QB10Z1S/2	AlGaInN	458	water clear	500	2	21	90°	
KTDG-9072SE9Z1S/2	AlGaInP	623	water clear	500	2	50	90°	<p>9.0mm x 7.0mm x 4.2mm</p> <p>POLARITY MARK</p> <p>1 2 Z1 PAD 3 NO CONNECTION</p> <p>Units : mm(inch) Tolerance : ±0.25(0.01)</p>
KTDG-9072SY9Z1S/2	AlGaInP	591	water clear	500	2	53	90°	
KTDG-9072ZG10Z1S/2	AlGaInN	530	water clear	500	2	70	90°	
KTDG-9072QB10Z1S/2	AlGaInN	458	water clear	500	2	21	90°	

HIGH BRIGHTNESS LED LIGHT BAR

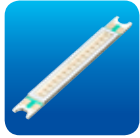
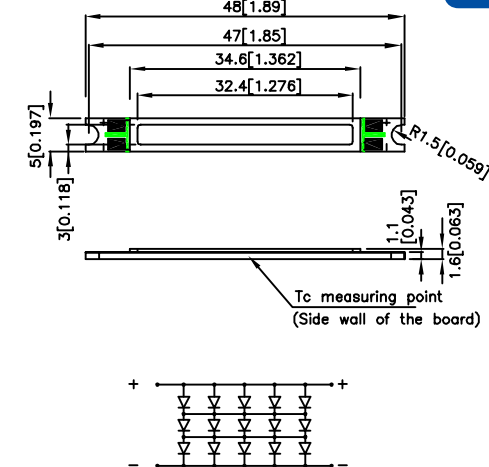
PART NUMBER	MATERIAL	λ_D (nm)	LENS TYPE	IF (mA)	Pd (W)	Φ_v (lm)	VIEWING ANGLE	DIMENSION
					TYP.	TYP.		
KASL-4805ZGSX15/3	InGaN	525	water clear	350	4.55	35	120°	48mm x 5mm x 1.6mm  KASL-4805  Units : mm(inch) Tolerance : ±0.25(0.01)
KASL-4805QBFSX15/3	InGaN	465	water clear	350	4.2	25	120°	
KASL-4805SEL1SX15/5	AlGaInP	618	water clear	500	4.6	100	120°	
KASL-4805SYL1SX15/5	AlGaInP	590	water clear	500	4.95	100	120°	
KASL-4805ZG25SX15/7	InGaN	525	water clear	700	8.12	260	120°	
KASL-4805QB25SX15/7	InGaN	450	water clear	700	8.12	53	120°	

FULL-COLOR SURFACE MOUNT LED LAMP

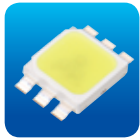
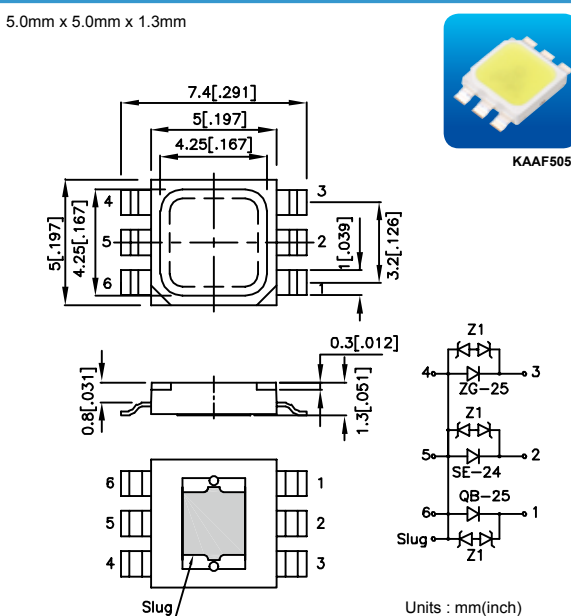
PART NUMBER	MATERIAL	λ_D (nm)	LENS TYPE	IF (mA)	Pd (W)	Φ_v (mlm)	VIEWING ANGLE	DIMENSION
					TYP.	TYP.		
KAAF5051 QB25SE24ZG25Z1X3S	InGaN	450	water clear	150	0.6	4500	120°	5.0mm x 5.0mm x 1.3mm  KAAF5051  Units : mm(inch) Tolerance : ±0.25(0.01)
	AlGaInP	624		150	0.45	11000		
	InGaN	525		150	0.6	20000		

Kingbright

Optoelectronic Components





SMD LED

9

Top-Emitting PLCC SMD LED	9
Top-Emitting Chip SMD LED	10
Right Angle SMD LED	16
Multi-Color SMD LED	19
Subminiature SMD LED	23
Reverse Mount SMD LED	25
SOT-23 SMD LED	25
Ambient Light Sensor	26
Color Sensor	26

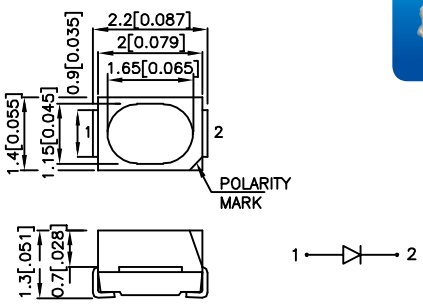

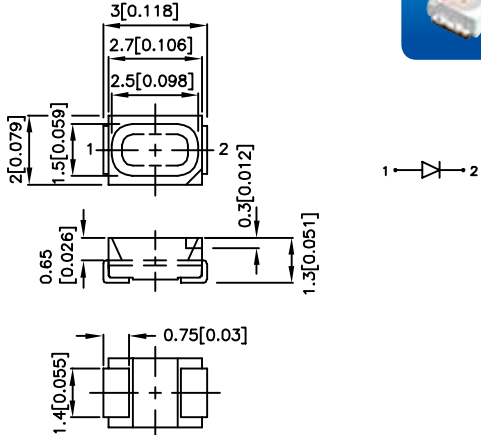
TOP-EMITTING PLCC SMD LED

PART NUMBER	MATERIAL	λD (nm)	LENS TYPE	Iv (mcd) @20mA		VIEWING ANGLE 2θ1/2	DIMENSION
				MIN.	TYP.		
KA-2214SURSK	AlGaInP	630	water clear	180	400	120°	<p>2.2mm x 1.4mm</p>  <p>KA-2214</p>  <p>Units : mm(inch) Tolerance : ±0.2(0.008)</p>
KA-2214SESK	AlGaInP	601	water clear	280	450	120°	
KA-2214MGS	AlGaInP	570	water clear	50	150	120°	
KA-2214CGSK	AlGaInP	570	water clear	50	100	120°	
KA-2214ZGS	InGaN	525	water clear	280	550	120°	
KA-2214QBS-G	InGaN	465	water clear	110	300	120°	
KA-3021SURCKT	AlGaInP	630	water clear	70	200	125°	<p>3.0mm x 2.0mm (1208)</p>  <p>KA-3021</p>  <p>Units : mm(inch) Tolerance : ±0.25(0.01)</p>
KA-3021SECKT	AlGaInP	601	water clear	180	400	125°	
KA-3021SYCKT	AlGaInP	590	water clear	110	200	125°	
KA-3021MGCT	AlGaInP	570	water clear	50	100	125°	
KA-3021CGCKT	AlGaInP	570	water clear	50	85	125°	
KA-3021ZGCT	InGaN	525	water clear	380	500	125°	
KA-3021ZGCT-E	InGaN	525	water clear	900	1500	125°	
KA-3021ZGCT-G	InGaN	525	water clear	1200	1600	125°	
KA-3021QBCT-D	InGaN	470	water clear	50	150	125°	
KA-3021QBCT-F	InGaN	465	water clear	110	250	125°	
KA-3021QBCT-G	InGaN	465	water clear	180	350	125°	
KA-3022ECT-4.5SF	GaAsP/GaP	625	water clear	7	30	90°	
KA-3022SRCT-4.5SF	GaAlAs	640	water clear	36	150	90°	
KA-3022YCT-4.5SF	GaAsP/GaP	588	water clear	4	15	90°	
KA-3022SGCT-4.5SF	GaP	568	water clear	7	20	90°	
KA-3022ZGCT-4.5SF	InGaN	525	water clear	280	500	90°	
KA-3022ZGCT-E-4.5SF	InGaN	525	water clear	380	800	90°	
KA-3022ZGCT-G-4.5SF	InGaN	525	water clear	480	900	90°	
KA-3022QBCT-D-4.5SF	InGaN	470	water clear	50	150	90°	
KA-3022QBCT-F-4.5SF	InGaN	465	water clear	70	180	90°	
KA-3022QBCT-G-4.5SF	InGaN	465	water clear	110	250	90°	

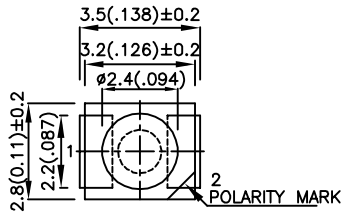
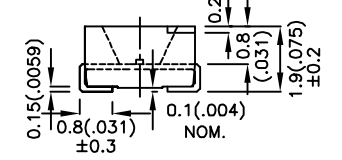
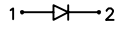
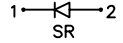
TOP-EMITTING PLCC SMD LED



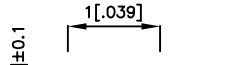
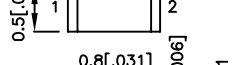
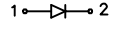

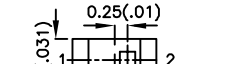
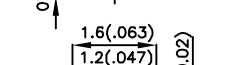
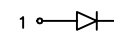

PART NUMBER	MATERIAL	λ_D (nm)	LENS TYPE	Iv (mcd) @20mA		VIEWING ANGLE 2 θ 1/2	DIMENSION
				MIN.	TYP.		
KA-3528ECT	GaAsP/GaP	625	water clear	7	30	120°	3.5mm x 2.8mm  KA-3528   POLARITY MARK   Units : mm(inch) Tolerance : ±0.25(0.01)
KA-3528SRCT	GaAlAs	640	water clear	50	150	120°	
KA-3528SURCKT	AlGaInP	630	water clear	70	350	120°	
KA-3528SECKT	AlGaInP	601	water clear	110	400	120°	
KA-3528YCT	GaAsP/GaP	588	water clear	4	20	120°	
KA-3528SYCKT	AlGaInP	590	water clear	70	200	120°	
KA-3528SGCT	GaP	568	water clear	10	25	120°	
KA-3528MGCT	AlGaInP	570	water clear	50	150	120°	
KA-3528CGCKT	AlGaInP	570	water clear	36	100	120°	
KA-3528ZGCT	InGaN	525	water clear	380	600	120°	
KA-3528ZGCT-E	InGaN	525	water clear	480	900	120°	
KA-3528ZGCT-G	InGaN	525	water clear	650	1000	120°	
KA-3528QBCT-D	InGaN	470	water clear	50	150	120°	
KA-3528QBCT-F	InGaN	465	water clear	110	280	120°	
KA-3528QBCT-G	InGaN	465	water clear	180	370	120°	

TOP-EMITTING CHIP SMD LED

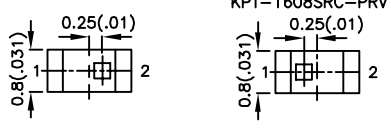
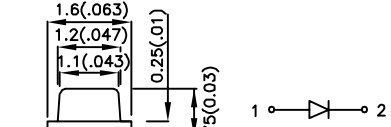
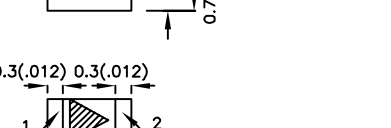
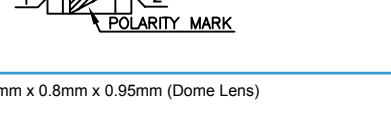
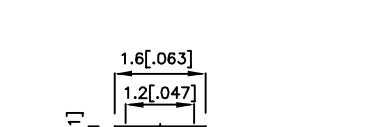
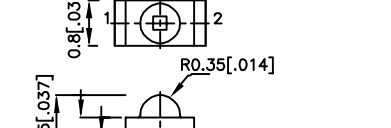
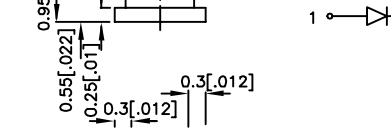
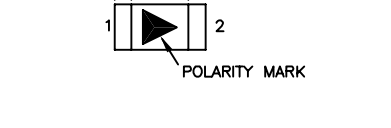
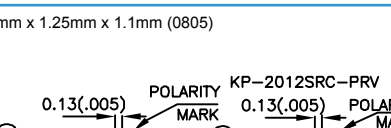
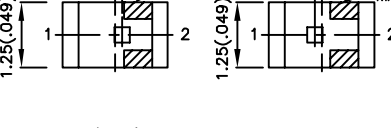
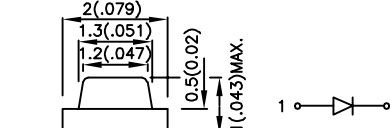
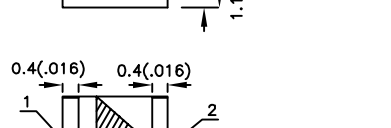
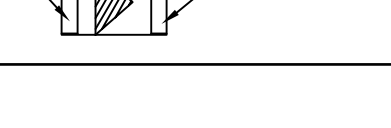
PART NUMBER	MATERIAL	λ_D (nm)	LENS TYPE	Iv (mcd) @20mA		VIEWING ANGLE 2 θ 1/2	DIMENSION
				MIN.	TYP.		
KPHHS-1005SURCK	AlGaInP	630	water clear	70	220	120°	1.0mm x 0.5mm x 0.5mm (0402)  KPHHS-1005    Units : mm(inch) Tolerance : ±0.1(0.004)
KPHHS-1005SECK	AlGaInP	601	water clear	70	240	120°	
KPHHS-1005SYCK	AlGaInP	590	water clear	50	150	120°	
KPHHS-1005CGCK	AlGaInP	570	water clear	10	50	120°	
KPHHS-1005ZGC-V	InGaN	525	water clear	110	300	120°	
KPHHS-1005QBC-D-V	InGaN	470	water clear	36	100	120°	
KP-1608SURCK	AlGaInP	630	water clear	70	220	120°	1.6mm x 0.8mm x 1.1mm (0603)  KP-1608    Units : mm(inch) Tolerance : ±0.1(0.004)
KP-1608SECK	AlGaInP	601	water clear	70	240	120°	
KP-1608SYCK	AlGaInP	590	water clear	50	150	120°	
KP-1608MGC	AlGaInP	570	water clear	36	70	120°	
KP-1608CGCK	AlGaInP	570	water clear	10	50	120°	
KP-1608ZGC	InGaN	525	water clear	110	300	120°	
KP-1608ZGC-E	InGaN	525	water clear	280	650	120°	
KP-1608ZGC-G	InGaN	525	water clear	380	700	120°	
KP-1608QBC-D	InGaN	470	water clear	36	100	120°	
KP-1608QBC-F	InGaN	465	water clear	50	150	120°	
KP-1608QBC-G	InGaN	465	water clear	70	180	120°	

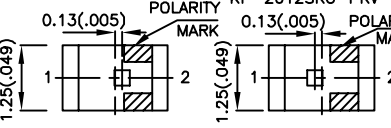

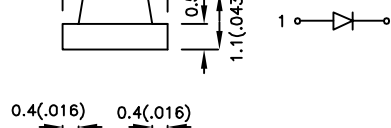
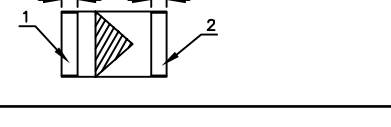
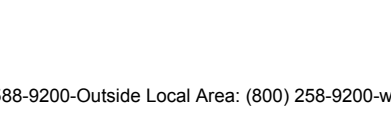

NOTE:
1.KP series custom-made is available upon request.

TOP-EMITTING CHIP SMD LED

PART NUMBER	MATERIAL	λ_D (nm)	LENS TYPE	Iv (mcd) @20mA		VIEWING ANGLE 2 θ 1/2	DIMENSION
				MIN.	TYP.		
KPT-1608EC	GaAsP/GaP	625	water clear	4	15	120°	1.6mm x 0.8mm x 0.75mm (0603 Super Thin)  KPT-1608  KPT-1608SRC-PRV  KPT-1608SECK  KPT-1608YC  KPT-1608SYCK  KPT-1608SGC  KPT-1608MGC  KPT-1608CGCK  KPT-1608ZGC  KPT-1608ZGC-E  KPT-1608ZGC-G  KPT-1608QBC-D  KPT-1608QBC-F  KPT-1608QBC-G Units : mm(inch) Tolerance : $\pm 0.1(0.004)$
KPT-1608SRC-PRV	GaAlAs	640	water clear	36	100	120°	
KPT-1608SURCK	AlGaInP	630	water clear	70	220	120°	
KPT-1608SECK	AlGaInP	601	water clear	70	240	120°	
KPT-1608YC	GaAsP/GaP	588	water clear	2.6	8	120°	
KPT-1608SYCK	AlGaInP	590	water clear	50	150	120°	
KPT-1608SGC	GaP	568	water clear	4	15	120°	
KPT-1608MGC	AlGaInP	570	water clear	36	70	120°	
KPT-1608CGCK	AlGaInP	570	water clear	10	50	120°	
KPT-1608ZGC	InGaN	525	water clear	110	300	120°	
KPT-1608ZGC-E	InGaN	525	water clear	280	650	120°	
KPT-1608ZGC-G	InGaN	525	water clear	380	700	120°	
KPT-1608QBC-D	InGaN	470	water clear	36	100	120°	
KPT-1608QBC-F	InGaN	465	water clear	50	150	120°	
KPT-1608QBC-G	InGaN	465	water clear	70	180	120°	
KPTD-1608SURCK	AlGaInP	630	water clear	480	700	60°	
KPTD-1608SECK	AlGaInP	601	water clear	480	800	60°	
KPTD-1608SYCK	AlGaInP	590	water clear	280	480	60°	
KPTD-1608MGC	AlGaInP	570	water clear	110	250	60°	
KPTD-1608CGCK	AlGaInP	570	water clear	70	180	60°	
KPTD-1608ZGC	InGaN	525	water clear	380	780	60°	
KPTD-1608ZGC-E	InGaN	525	water clear	480	850	60°	
KPTD-1608ZGC-G	InGaN	525	water clear	650	1200	60°	
KPTD-1608QBC-D	InGaN	470	water clear	70	250	40°	
KPTD-1608QBC-F	InGaN	465	water clear	110	270	40°	
KPTD-1608QBC-G	InGaN	465	water clear	180	300	40°	
KP-2012EC	GaAsP/GaP	625	water clear	4	15	120°	2.0mm x 1.25mm x 1.1mm (0805)  KP-2012  KP-2012SRC-PRV  KP-2012SURCK  KP-2012SECK  KP-2012YC  KP-2012SYCK  KP-2012SGC KP-2012MGC KP-2012CGCK KP-2012ZGC KP-2012ZGC-E KP-2012ZGC-G KP-2012QBC-D KP-2012QBC-F KP-2012QBC-G Units : mm(inch) Tolerance : $\pm 0.1(0.004)$
KP-2012SRC-PRV	GaAlAs	640	water clear	36	100	120°	
KP-2012SURCK	AlGaInP	630	water clear	70	220	120°	
KP-2012SECK	AlGaInP	601	water clear	70	240	120°	
KP-2012YC	GaAsP/GaP	588	water clear	2.6	8	120°	
KP-2012SYCK	AlGaInP	590	water clear	50	150	120°	
KP-2012SGC	GaP	568	water clear	4	15	120°	
KP-2012MGC	AlGaInP	570	water clear	36	70	120°	
KP-2012CGCK	AlGaInP	570	water clear	10	50	120°	
KP-2012ZGC	InGaN	525	water clear	110	300	120°	
KP-2012ZGC-E	InGaN	525	water clear	280	650	120°	
KP-2012ZGC-G	InGaN	525	water clear	380	700	120°	
KP-2012QBC-D	InGaN	470	water clear	36	100	120°	
KP-2012QBC-F	InGaN	465	water clear	50	150	120°	
KP-2012QBC-G	InGaN	465	water clear	70	180	120°	

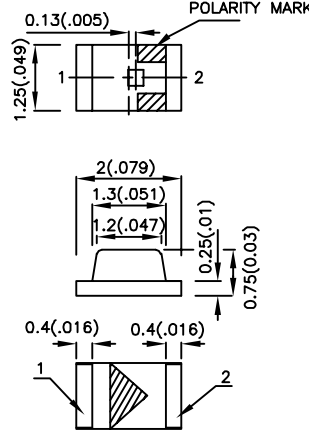
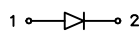

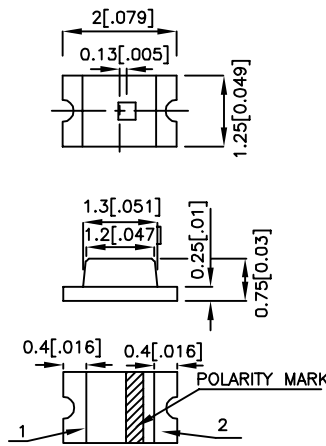
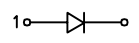

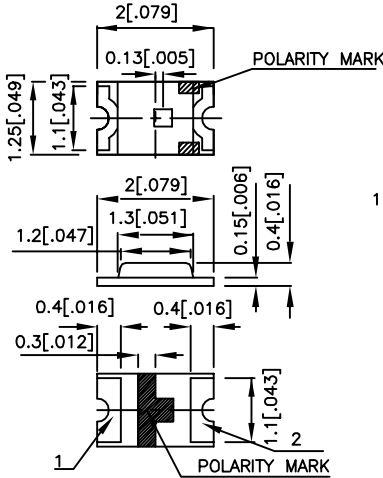
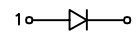
NOTE:
1.KP series custom-made is available upon request.

TOP-EMITTING CHIP SMD LED

PART NUMBER	MATERIAL	λ_D (nm)	LENS TYPE	Iv (mcd) @20mA		VIEWING ANGLE	DIMENSION	
				MIN.	TYP.			
KPT-2012SURCK	AlGaInP	630	water clear	70	220	120°	2.0mm x 1.25mm x 0.75mm  KPT-2012   Units : mm(inch) Tolerance : ±0.1(0.004)	
KPT-2012SECK	AlGaInP	601	water clear	70	240	120°		
KPT-2012SYCK	AlGaInP	590	water clear	50	150	120°		
KPT-2012MGC	AlGaInP	570	water clear	36	70	120°		
KPT-2012CGCK	AlGaInP	570	water clear	10	50	120°		
KPT-2012ZGC	InGaN	525	water clear	110	300	120°		
KPT-2012ZGC-E	InGaN	525	water clear	280	650	120°		
KPT-2012ZGC-G	InGaN	525	water clear	380	700	120°		
KPT-2012QBC-D	InGaN	470	water clear	36	100	120°		
KPT-2012QBC-F	InGaN	465	water clear	50	150	120°		
KPT-2012QBC-G	InGaN	465	water clear	70	180	120°		
KPTC-2012SURCK	AlGaInP	630	water clear	70	220	120°		2.0mm x 1.25mm x 0.75mm  KPTC-2012   Units : mm(inch) Tolerance : ±0.1(0.004)
KPTC-2012SECK	AlGaInP	601	water clear	70	240	120°		
KPTC-2012SYCK	AlGaInP	590	water clear	50	150	120°		
KPTC-2012MGC	AlGaInP	570	water clear	36	70	120°		
KPTC-2012CGCK	AlGaInP	570	water clear	10	50	120°		
KPTC-2012ZGC	InGaN	525	water clear	110	300	120°		
KPTC-2012ZGC-E	InGaN	525	water clear	280	650	120°		
KPTC-2012ZGC-G	InGaN	525	water clear	380	700	120°		
KPTC-2012QBC-D	InGaN	470	water clear	36	100	120°	2.0mm x 1.25mm x 0.4mm (0805 Super Thin)  KPHCM-2012   Units : mm(inch) Tolerance : ±0.1(0.004)	
KPHCM-2012SURCK	AlGaInP	630	water clear	70	220	110°		
KPHCM-2012SECK	AlGaInP	601	water clear	70	240	110°		
KPHCM-2012SYCK	AlGaInP	590	water clear	50	150	110°		
KPHCM-2012CGCK	AlGaInP	570	water clear	10	50	110°		
KPHCM-2012ZGC	InGaN	525	water clear	110	300	110°		
KPHCM-2012ZGC-E	InGaN	525	water clear	280	650	110°		
KPHCM-2012ZGC-G	InGaN	525	water clear	380	700	110°		
KPHCM-2012QBC-D	InGaN	470	water clear	36	100	110°		
KPHCM-2012QBC-F	InGaN	465	water clear	50	150	110°		
KPHCM-2012QBC-G	InGaN	465	water clear	70	180	110°		

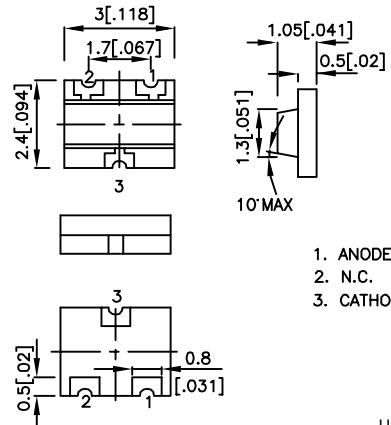

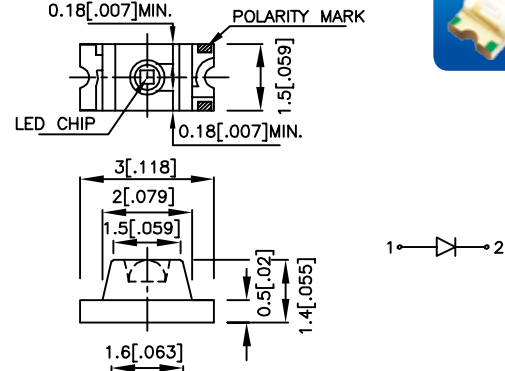

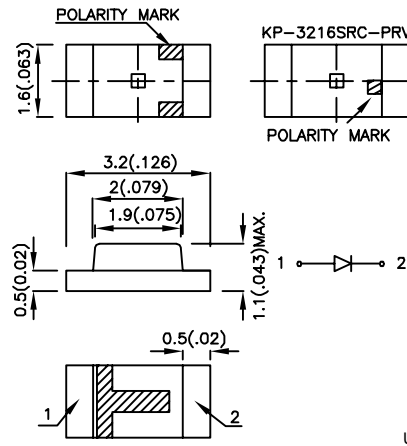
NOTE:
1.KP series custom-made is available upon request.

TOP-EMITTING CHIP SMD LED

PART NUMBER	MATERIAL	λ_D (nm)	LENS TYPE	Iv (mcd) @20mA		VIEWING ANGLE 2 θ 1/2	DIMENSION	
				MIN.	TYP.			
KP-23SURCK-F	AlGaInP	630	water clear	70	220	120°	<p>3.0mm x 2.4mm x 1.05mm</p>  <p>KP-23-F</p>  <p>Units : mm(inch) Tolerance : ±0.2(0.008)</p>	
KP-23SECK-F	AlGaInP	601	water clear	70	240	120°		
KP-23SYCK-F	AlGaInP	590	water clear	50	150	120°		
KP-23MGC-F	AlGaInP	570	water clear	36	70	120°		
KP-23CGCK-F	AlGaInP	570	water clear	18	50	120°		
KP-23ZGC-F	InGaN	525	water clear	110	380	120°		
KP-23ZGC-E-F	InGaN	525	water clear	280	650	120°		
KP-23ZGC-G-F	InGaN	525	water clear	380	700	120°		
KP-23QBC-D-F	InGaN	470	water clear	36	100	120°		
KP-23QBC-F-F	InGaN	465	water clear	50	120	120°		
KP-23QBC-G-F	InGaN	465	water clear	70	180	120°		
KPL-3015SURCK	AlGaInP	630	water clear	280	500	70°		<p>3.0mm x 1.5mm x 1.4mm (1106)</p>  <p>KPL-3015</p>  <p>Units : mm(inch) Tolerance : ±0.2(0.008)</p>
KPL-3015SECK	AlGaInP	601	water clear	280	550	70°		
KPL-3015SYCK	AlGaInP	590	water clear	110	300	70°		
KPL-3015MGC	AlGaInP	570	water clear	70	140	70°		
KPL-3015CGCK	AlGaInP	570	water clear	50	100	70°		
KPL-3015ZGC	InGaN	525	water clear	380	850	70°		
KPL-3015ZGC-E	InGaN	525	water clear	650	1300	70°		
KPL-3015ZGC-G	InGaN	525	water clear	900	1500	70°		
KPL-3015QBC-D	InGaN	470	water clear	70	180	70°		
KPL-3015QBC-F	InGaN	465	water clear	110	250	70°		
KPL-3015QBC-G	InGaN	465	water clear	180	320	70°		
KP-3216EC	GaAsP/GaP	625	water clear	4	15	120°	<p>3.2mm x 1.6mm x 1.1mm (1206)</p>  <p>KP-3216</p>  <p>Units : mm(inch) Tolerance : ±0.2(0.008)</p>	
KP-3216SRC-PRV	GaAlAs	640	water clear	36	100	120°		
KP-3216SURCK	AlGaInP	630	water clear	70	220	120°		
KP-3216SECK	AlGaInP	601	water clear	70	240	120°		
KP-3216YC	GaAsP/GaP	588	water clear	2.6	8	120°		
KP-3216SYCK	AlGaInP	590	water clear	50	150	120°		
KP-3216SGC	GaP	568	water clear	4	15	120°		
KP-3216MGC	AlGaInP	570	water clear	36	70	120°		
KP-3216CGCK	AlGaInP	570	water clear	10	50	120°		
KP-3216ZGC	InGaN	525	water clear	110	300	120°		
KP-3216ZGC-E	InGaN	525	water clear	280	650	120°		
KP-3216ZGC-G	InGaN	525	water clear	380	700	120°		
KP-3216QBC-D	InGaN	470	water clear	36	100	120°		
KP-3216QBC-F	InGaN	465	water clear	50	150	120°		
KP-3216QBC-G	InGaN	465	water clear	70	180	120°		

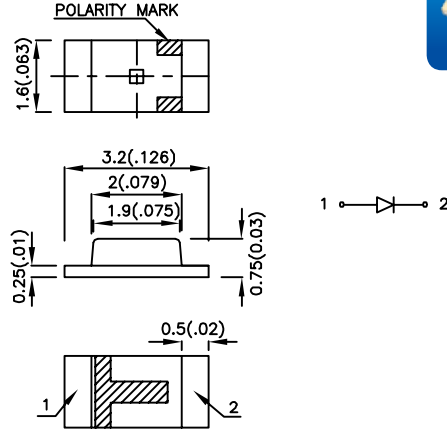

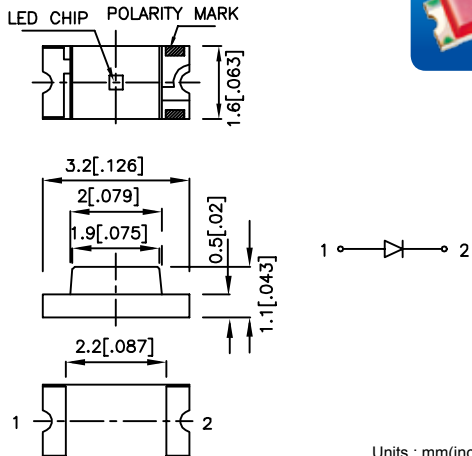
NOTE:
1.KP series custom-made is available upon request.

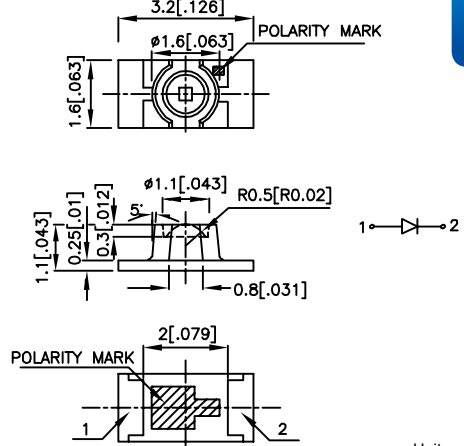
TOP-EMITTING CHIP SMD LED

PART NUMBER	MATERIAL	λ_D (nm)	LENS TYPE	Iv (mcd) @20mA		VIEWING ANGLE	DIMENSION	
				MIN.	TYP.			
KPT-3216SURCK	AlGaInP	630	water clear	70	220	120°	3.2mm x 1.6mm x 0.75mm (1206 Super Thin)  KPT-3216  Units : mm(inch) Tolerance : ±0.2(0.008)	
KPT-3216SECK	AlGaInP	601	water clear	70	240	120°		
KPT-3216SYCK	AlGaInP	590	water clear	50	150	120°		
KPT-3216MGC	AlGaInP	570	water clear	36	70	120°		
KPT-3216CGCK	AlGaInP	570	water clear	10	50	120°		
KPT-3216ZGC	InGaN	525	water clear	110	300	120°		
KPT-3216ZGC-E	InGaN	525	water clear	280	650	120°		
KPT-3216ZGC-G	InGaN	525	water clear	380	700	120°		
KPT-3216QBC-D	InGaN	470	water clear	36	100	120°		
KPT-3216QBC-F	InGaN	465	water clear	50	150	120°		
KPT-3216QBC-G	InGaN	465	water clear	70	180	120°		
KPC-3216SURCK	AlGaInP	630	water clear	70	220	120°		3.2mm x 1.6mm x 1.1mm (1206)  KPC-3216  Units : mm(inch) Tolerance : ±0.2(0.008)
KPC-3216SECK	AlGaInP	601	water clear	70	240	120°		
KPC-3216SYCK	AlGaInP	590	water clear	50	150	120°		
KPC-3216MGC	AlGaInP	570	water clear	36	70	120°		
KPC-3216CGCK	AlGaInP	570	water clear	10	50	120°		
KPC-3216ZGC	InGaN	525	water clear	110	300	120°		
KPC-3216ZGC-E	InGaN	525	water clear	280	650	120°		
KPC-3216ZGC-G	InGaN	525	water clear	380	700	120°		
KPC-3216QBC-D	InGaN	470	water clear	36	100	120°		
KPC-3216QBC-F	InGaN	465	water clear	50	150	120°		
KPC-3216QBC-G	InGaN	465	water clear	70	180	120°		
KPTL-3216SURCK	AlGaInP	630	water clear	280	550	70°	3.2mm x 1.6mm x 1.1mm (1206)  KPTL-3216  Units : mm(inch) Tolerance : 0.1(0.004)	
KPTL-3216SECK	AlGaInP	601	water clear	280	600	70°		
KPTL-3216SYCK	AlGaInP	590	water clear	110	350	70°		
KPTL-3216CGCK	AlGaInP	570	water clear	70	200	70°		
KPTL-3216ZGC	InGaN	525	water clear	480	1100	70°		
KPTL-3216ZGC-E	InGaN	525	water clear	650	1600	70°		
KPTL-3216ZGC-G	InGaN	525	water clear	900	1800	70°		
KPTL-3216QBC-D	InGaN	470	water clear	110	300	70°		
KPTL-3216QBC-F	InGaN	465	water clear	180	360	70°		
KPTL-3216QBC-G	InGaN	465	water clear	280	400	70°		

NOTE:
1.KP series custom-made is available upon request.

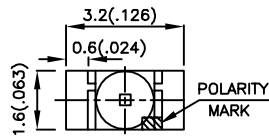
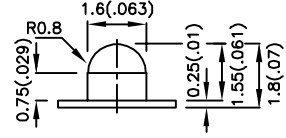
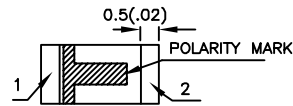
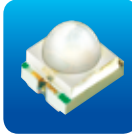
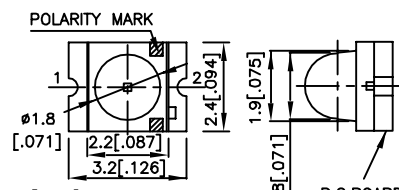
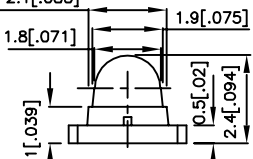
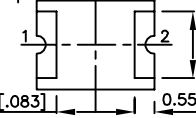
TOP-EMITTING CHIP SMD LED

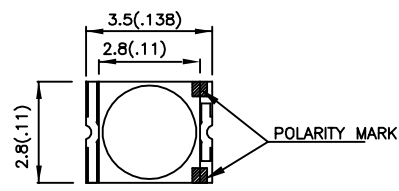
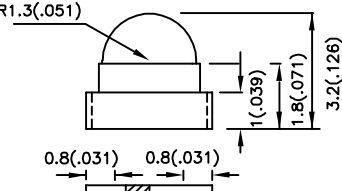
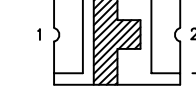
PART NUMBER	MATERIAL	λ_D (nm)	LENS TYPE	Iv (mcd) @20mA		VIEWING ANGLE 2 θ 1/2	DIMENSION	
				MIN.	TYP.			
KPTD-3216SURCK	AlGaInP	630	water clear	480	1500	50°	3.2mm x 1.6mm x 1.8mm (1206 Dome Lens)     <p>Units : mm(inch) Tolerance : ±0.2(0.008)</p>	
KPTD-3216SECK	AlGaInP	601	water clear	650	1600	50°		
KPTD-3216SYCK	AlGaInP	590	water clear	380	900	50°		
KPTD-3216MGC	AlGaInP	570	water clear	110	450	50°		
KPTD-3216CGCK	AlGaInP	570	water clear	110	300	50°		
KPTD-3216ZGC	InGaN	525	water clear	900	2000	50°		
KPTD-3216ZGC-E	InGaN	525	water clear	2200	3500	50°		
KPTD-3216ZGC-G	InGaN	525	water clear	2500	4000	50°		
KPTD-3216QBC-D	InGaN	470	water clear	280	500	40°		
KPTD-3216QBC-F	InGaN	465	water clear	380	850	40°		
KPTD-3216QBC-G	InGaN	465	water clear	480	900	40°		
KPD-3224SURCK	AlGaInP	630	water clear	650	2500	20°		3.2mm x 2.4mm x 2.4mm (Dome Lens)     <p>Units : mm(inch) Tolerance : ±0.1(0.004)</p>
KPD-3224SECK	AlGaInP	601	water clear	900	2600	20°		
KPD-3224SYCK	AlGaInP	590	water clear	480	1400	20°		
KPD-3224MGC	AlGaInP	570	water clear	380	700	20°		
KPD-3224CGCK	AlGaInP	570	water clear	280	700	20°		
KPD-3224ZGC	InGaN	525	water clear	1200	2400	20°		
KPD-3224ZGC-E	InGaN	525	water clear	2800	5000	20°		
KPD-3224ZGC-G	InGaN	525	water clear	3300	5300	20°		
KPD-3224QBC-D	InGaN	470	water clear	380	900	20°		
KPD-3224QBC-F	InGaN	465	water clear	480	1200	20°		
KPD-3224QBC-G	InGaN	465	water clear	650	1400	20°		
KPED-3528SURCK	AlGaInP	630	water clear	380	800	40°	3.5mm x 2.8mm x 3.2mm (Dome Lens)     <p>Units : mm(inch) Tolerance : ±0.2(0.008)</p>	
KPED-3528SECK	AlGaInP	601	water clear	480	900	40°		
KPED-3528SYCK	AlGaInP	590	water clear	180	500	40°		
KPED-3528MGC	AlGaInP	570	water clear	110	250	40°		
KPED-3528CGCK	AlGaInP	570	water clear	70	200	40°		
KPED-3528ZGC	InGaN	525	water clear	480	1400	40°		
KPED-3528ZGC-E	InGaN	525	water clear	1800	2700	40°		
KPED-3528ZGC-G	InGaN	525	water clear	2200	3000	40°		
KPED-3528QBC-D	InGaN	470	water clear	180	500	40°		
KPED-3528QBC-F	InGaN	465	water clear	380	700	40°		
KPED-3528QBC-G	InGaN	465	water clear	480	800	40°		

NOTE:
1.KP series custom-made is available upon request.

TOP-EMITTING CHIP SMD LED

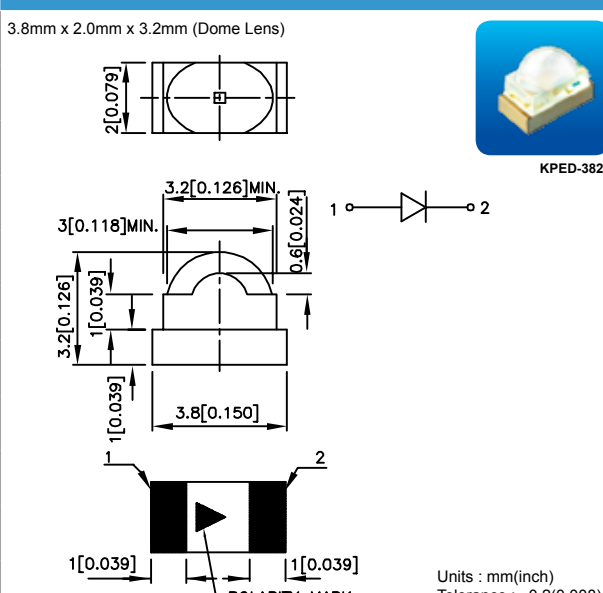

PART NUMBER	MATERIAL	λ_D (nm)	LENS TYPE	Iv (mcd) @20mA		VIEWING ANGLE 2 θ 1/2	DIMENSION
				MIN.	TYP.		
KPED-3820SURCK	AlGaInP	630	water clear	280	700	60°(H) 35°(V)	3.8mm x 2.0mm x 3.2mm (Dome Lens)  Units : mm(inch) Tolerance : ±0.2(0.008)
KPED-3820SECK	AlGaInP	601	water clear	280	800	60°(H) 35°(V)	
KPED-3820SYCK	AlGaInP	590	water clear	110	450	60°(H) 35°(V)	
KPED-3820MGC	AlGaInP	570	water clear	110	250	60°(H) 35°(V)	
KPED-3820CGCK	AlGaInP	570	water clear	70	170	60°(H) 35°(V)	
KPED-3820ZGC	InGaN	525	water clear	480	1200	60°(H) 35°(V)	
KPED-3820ZGC-E	InGaN	525	water clear	1500	2500	60°(H) 35°(V)	
KPED-3820ZGC-G	InGaN	525	water clear	1800	2700	60°(H) 35°(V)	
KPED-3820QBC-D	InGaN	470	water clear	110	300	60°(H) 35°(V)	
KPED-3820QBC-F	InGaN	465	water clear	280	450	60°(H) 35°(V)	
KPED-3820QBC-G	InGaN	465	water clear	380	650	60°(H) 35°(V)	

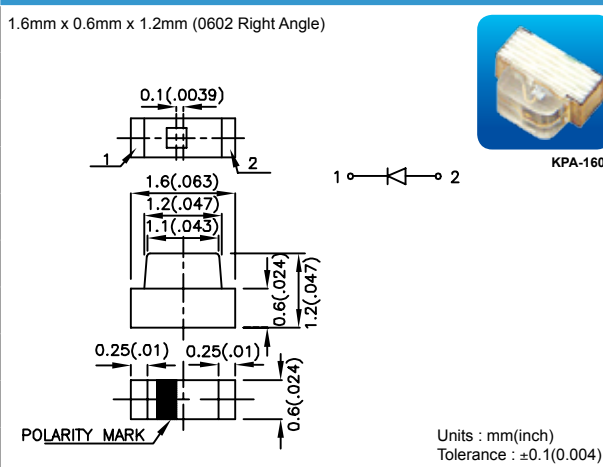
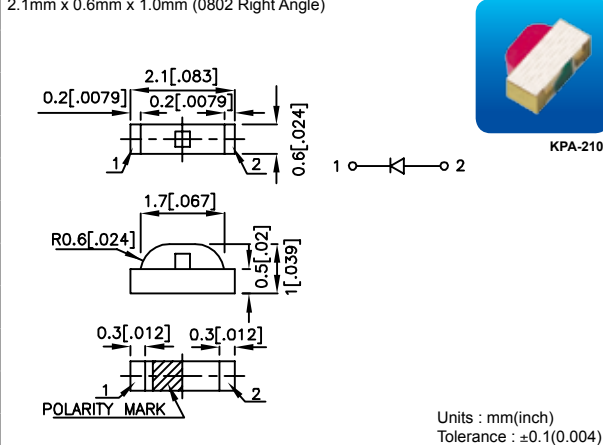
RIGHT ANGLE SMD LED

PART NUMBER	MATERIAL	λ_D (nm)	LENS TYPE	Iv (mcd) @20mA		VIEWING ANGLE 2 θ 1/2	DIMENSION
				MIN.	TYP.		
KPA-1606SURCK	AlGaInP	630	water clear	110	250	110°	1.6mm x 0.6mm x 1.2mm (0602 Right Angle)  Units : mm(inch) Tolerance : ±0.1(0.004)
KPA-1606SECK	AlGaInP	601	water clear	110	300	110°	
KPA-1606SYCK	AlGaInP	590	water clear	50	150	110°	
KPA-1606CGCK	AlGaInP	570	water clear	18	60	110°	
KPA-1606ZGC	InGaN	525	water clear	110	350	110°	
KPA-1606ZGC-E	InGaN	525	water clear	280	600	110°	
KPA-1606ZGC-G	InGaN	525	water clear	380	650	110°	
KPA-1606QBC-D	InGaN	470	water clear	36	90	110°	
KPA-1606QBC-F	InGaN	465	water clear	50	120	110°	
KPA-1606QBC-G	InGaN	465	water clear	70	150	110°	
KPA-2106SURCK	AlGaInP	630	water clear	110	250	120°	2.1mm x 0.6mm x 1.0mm (0802 Right Angle)  Units : mm(inch) Tolerance : ±0.1(0.004)
KPA-2106SECK	AlGaInP	601	water clear	110	300	120°	
KPA-2106SYCK	AlGaInP	590	water clear	50	150	120°	
KPA-2106MGC	AlGaInP	570	water clear	36	80	120°	
KPA-2106CGCK	AlGaInP	570	water clear	18	60	120°	
KPA-2106ZGC	InGaN	525	water clear	110	350	120°	
KPA-2106ZGC-E	InGaN	525	water clear	280	600	120°	
KPA-2106ZGC-G	InGaN	525	water clear	380	650	120°	
KPA-2106QBC-D	InGaN	470	water clear	36	90	120°	
KPA-2106QBC-F	InGaN	465	water clear	50	120	120°	
KPA-2106QBC-G	InGaN	465	water clear	70	150	120°	



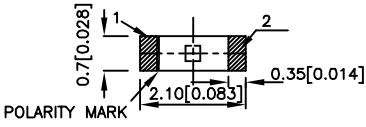
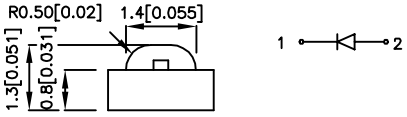
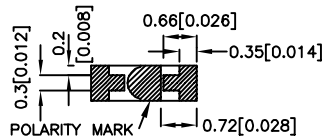
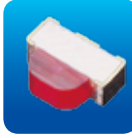
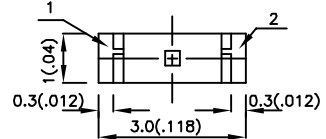
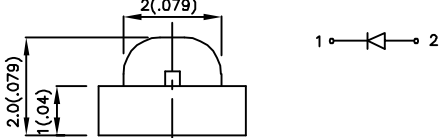
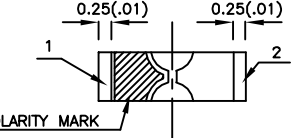

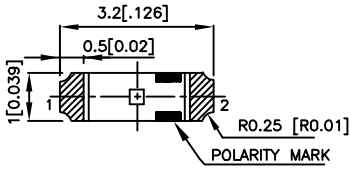
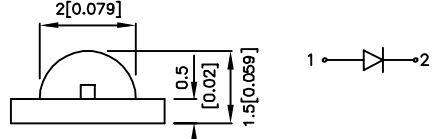
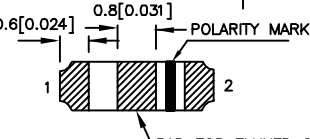
NOTE:
1.KP series custom-made is available upon request.

RIGHT ANGLE SMD LED

PART NUMBER	MATERIAL	λ_D (nm)	LENS TYPE	Iv (mcd) @20mA		VIEWING ANGLE 2 θ 1/2	DIMENSION	
				MIN.	TYP.			
KPJA-2107SURCK	AlGaInP	630	water clear	110	250	120°	<p>2.1mm x 0.7mm x 1.3mm (0802 Right Angle)</p>  <p>KPJA-2107</p>    <p>Units : mm(inch) Tolerance : 0.15(0.006)</p>	
KPJA-2107SECK	AlGaInP	601	water clear	110	300	120°		
KPJA-2107SYCK	AlGaInP	590	water clear	50	150	120°		
KPJA-2107MGC	AlGaInP	570	water clear	36	80	120°		
KPJA-2107CGCK	AlGaInP	570	water clear	18	60	120°		
KPJA-2107ZGC	InGaN	525	water clear	110	350	120°		
KPJA-2107ZGC-E	InGaN	525	water clear	280	600	120°		
KPJA-2107ZGC-G	InGaN	525	water clear	380	650	120°		
KPJA-2107QBC-D	InGaN	470	water clear	36	90	120°		
KPJA-2107QBC-F	InGaN	465	water clear	50	120	120°		
KPJA-2107QBC-G	InGaN	465	water clear	70	150	120°		
KPA-3010SURCK	AlGaInP	630	water clear	110	250	120°		<p>3.0mm x 1.0mm x 2.0mm (1104 Right Angle)</p>  <p>KPA-3010</p>    <p>Units : mm(inch) Tolerance : ±0.15(0.006)</p>
KPA-3010SECK	AlGaInP	601	water clear	110	300	120°		
KPA-3010SYCK	AlGaInP	590	water clear	50	150	120°		
KPA-3010MGC	AlGaInP	570	water clear	36	80	120°		
KPA-3010CGCK	AlGaInP	570	water clear	18	60	120°		
KPA-3010ZGC	InGaN	525	water clear	110	350	120°		
KPA-3010ZGC-E	InGaN	525	water clear	280	600	120°		
KPA-3010ZGC-G	InGaN	525	water clear	380	650	120°		
KPA-3010QBC-D	InGaN	470	water clear	36	90	120°		
KPA-3010QBC-F	InGaN	465	water clear	50	120	120°		
KPA-3010QBC-G	InGaN	465	water clear	70	150	120°		
KPA-3210SURCK	AlGaInP	630	water clear	110	250	120°	<p>3.2mm x 1.0mm x 1.5mm (1304 Right Angle)</p>  <p>KPA-3210</p>    <p>PAD FOR FLUXED ONLY</p> <p>Units : mm(inch) Tolerance : ±0.1(0.004)</p>	
KPA-3210SECK	AlGaInP	601	water clear	110	300	120°		
KPA-3210SYCK	AlGaInP	590	water clear	50	150	120°		
KPA-3210MGC	AlGaInP	570	water clear	36	80	120°		
KPA-3210CGCK	AlGaInP	570	water clear	18	60	120°		
KPA-3210ZGC	InGaN	525	water clear	110	350	120°		
KPA-3210ZGC-E	InGaN	525	water clear	280	600	120°		
KPA-3210ZGC-G	InGaN	525	water clear	380	650	120°		
KPA-3210QBC-D	InGaN	470	water clear	36	90	120°		
KPA-3210QBC-F	InGaN	465	water clear	50	120	120°		
KPA-3210QBC-G	InGaN	465	water clear	70	150	120°		

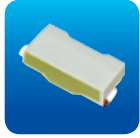
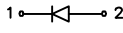
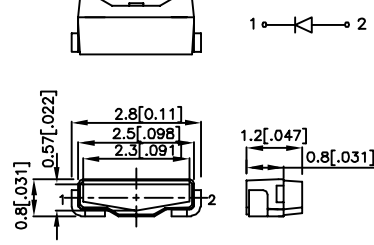
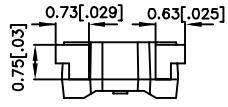
NOTE:
1.KP series custom-made is available upon request.

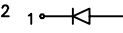
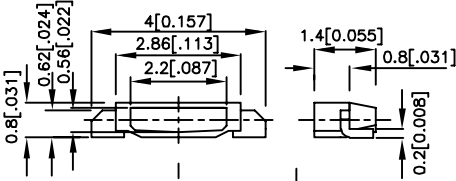
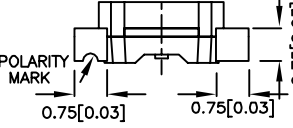
RIGHT ANGLE SMD LED

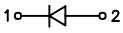
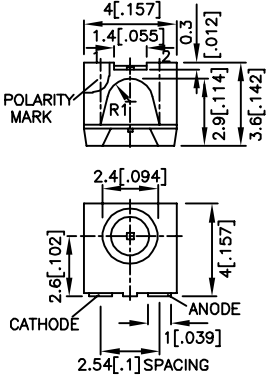
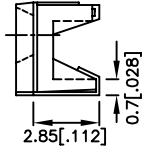





PART NUMBER	MATERIAL	λ_D (nm)	LENS TYPE	Iv (mcd) @20mA		VIEWING ANGLE	DIMENSION
				MIN.	TYP.		
KA-2810ASURSK	AlGaInP	630	water clear	70	200	110°	2.8mm x 0.8mm Right Angle    
KA-2810ASESK	AlGaInP	601	water clear	110	270	110°	
KA-2810ASYSK	AlGaInP	590	water clear	110	200	110°	
KA-2810ACGSK	AlGaInP	570	water clear	36	70	110°	
KA-2810AZGS	InGaN	525	water clear	380	750	110°	
KA-2810AZGS-E	InGaN	525	water clear	650	1300	110°	
KA-2810AZGS-G	InGaN	525	water clear	900	1500	110°	
KA-2810AQBS-D	InGaN	470	water clear	50	120	110°	
KA-2810AQBS-F	InGaN	465	water clear	110	250	110°	
KA-2810AQBS-G	InGaN	465	water clear	180	350	110°	
							Units : mm(inch) Tolerance : ±0.1(0.004)
KA-4008SURSK	AlGaInP	630	water clear	110	300	120°	4.0mm x 0.8mm Right Angle    
KA-4008SESK	AlGaInP	601	water clear	110	350	120°	
KA-4008SYSK	AlGaInP	590	water clear	70	250	120°	
KA-4008ZGS	InGaN	525	water clear	280	600	120°	
KA-4008ZGS-E	InGaN	525	water clear	650	1200	120°	
KA-4008ZGS-G	InGaN	525	water clear	900	1400	120°	
KA-4008QBS-D	InGaN	470	water clear	50	100	120°	
KA-4008QBS-F	InGaN	465	water clear	110	250	120°	
KA-4008QBS-G	InGaN	465	water clear	180	300	120°	
							Units : mm(inch) Tolerance : ±0.1(0.004)
KA-4040SURCKT	AlGaInP	630	water clear	70	250	90°	4.0mm x 4.0mm Right Angle    
KA-4040SECKT	AlGaInP	601	water clear	110	400	90°	
KA-4040SYCKT	AlGaInP	590	water clear	70	250	90°	
KA-4040MGCT	AlGaInP	570	water clear	50	100	90°	
KA-4040CGCKT	AlGaInP	570	water clear	36	70	90°	
KA-4040ZGCT	InGaN	525	water clear	380	600	90°	
KA-4040ZGCT-E	InGaN	525	water clear	480	1300	90°	
KA-4040ZGCT-G	InGaN	525	water clear	650	1500	90°	
KA-4040QBCT-D	InGaN	470	water clear	70	150	90°	
KA-4040QBCT-F	InGaN	465	water clear	110	220	90°	
KA-4040QBCT-G	InGaN	465	water clear	180	300	90°	

MULTI-COLOR SMD LED

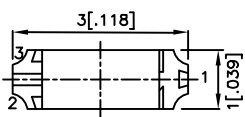
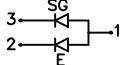
PART NUMBER	MATERIAL	λ_D (nm)	LENS TYPE	Iv (mcd) @20mA		VIEWING ANGLE 2 θ 1/2	DIMENSION	
				MIN.	TYP.			
KPTB-1612ESGC	GaAsP/GaP	625	water clear	4	15	120°	<p>1.6mm x 1.25mm x 0.65mm (0605 Bi-Color)</p> <p>Units : mm(inch) Tolerance : ±0.2(0.008)</p>	
	GaP	568		4	15			
KPTB-1612SURKCGKC	AlGaInP	630	water clear	70	220	120°		
	AlGaInP	570		18	50			
KPTB-1612SURKQBDC	AlGaInP	630	water clear	70	220	120°		
	InGaN	470		36	90			
KPTB-1612SYKCGKC	AlGaInP	590	water clear	50	150	120°		
	AlGaInP	570		18	50			
KPTB-1612QBDSEKC	InGaN	470	water clear	36	90	120°		
	AlGaInP	601		70	240			
KPTB-1615ESGC	GaAsP/GaP	625	water clear	4	15	120°		<p>1.6mm x 1.5mm x 0.7mm (0606 Bi-Color)</p> <p>Units : mm(inch) Tolerance : ±0.2(0.008)</p>
	GaP	568		4	15			
KPTB-1615SURKSGC	AlGaInP	630	water clear	70	220	120°		
	GaP	568		4	15			
KPTB-1615SURKCGKC	AlGaInP	630	water clear	70	220	120°		
	AlGaInP	570		18	50			
KPTB-1615SURKQBDC	AlGaInP	630	water clear	70	220	120°		
	InGaN	470		36	90			
KPTB-1615YSGC	GaAsP/GaP	588	water clear	2.6	8	120°		
	GaP	568		4	15			
KPTB-1615SYKCGKC	AlGaInP	590	water clear	50	150	120°		
	AlGaInP	570		18	50			
KPTB-1615SGNC	GaP	568	water clear	4	15	120°		
	GaAsP/GaP	610		4	15			
KPHBM-2012SURKCGKC	AlGaInP	630	water clear	70	220	120°	<p>2.0mm x 1.25mm x 0.45mm (Bi-Color)</p> <p>Units : mm(inch) Tolerance : ±0.1(0.004)</p>	
	AlGaInP	570		18	50			
KPHBM-2012CGKSEKC	AlGaInP	570	water clear	18	50	120°		
	AlGaInP	601		110	250			
KPHBM-2012QBDSURKC	InGaN	470	water clear	36	90	120°		
	AlGaInP	630		70	220			
KPHBM-2012QBDCGKC	InGaN	470	water clear	36	90	120°		
	AlGaInP	570		18	50			

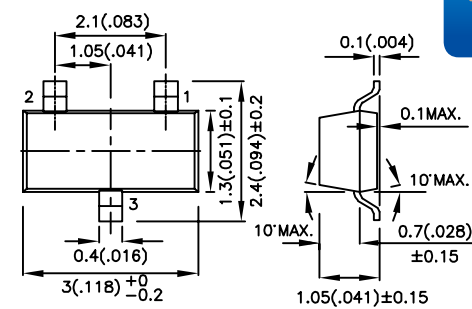
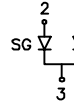
NOTE:
1.KP series custom-made is available upon request.

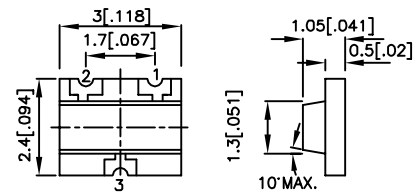
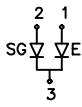
MULTI-COLOR SMD LED

PART NUMBER	MATERIAL	λ_D (nm)	LENS TYPE	Iv (mcd) @20mA		VIEWING ANGLE	DIMENSION	
				MIN.	TYP.			
KPBVA-3010ESGC	GaAsP/GaP	625	water clear	7	15	140°	3.0mm x 1.0mm x 2.0mm (1104 Right Angle, Bi-Color)   	
	GaP	568		7	15			
KPBVA-3010SRSGC-PRV	GaAlAs	640	water clear	50	140	140°		
	GaP	568		7	20			
KPBVA-3010SURKSGC	AlGaInP	630	water clear	110	300	140°		
	GaP	568		7	15			
KPBVA-3010SURKMGKC	AlGaInP	630	water clear	110	300	140°		
	AlGaInP	570		36	80			
KPBVA-3010SURKQBDC	AlGaInP	630	water clear	110	300	140°		
	InGaN	470		36	90			
KPBVA-3010YSGC	GaAsP/GaP	588	water clear	2.6	8	140°		
	GaP	568		7	15			
KPBVA-3010SYKCGKC	AlGaInP	590	water clear	50	150	140°		
	AlGaInP	570		18	50			
KM-23ESGW	GaAsP/GaP	625	white diffused	4	15	140°	SOT-23 Surface Mount LED Lamp (3mm x 1.3mm)   	
	GaP	568		4	15			
KM-23ESGC	GaAsP/GaP	625	water clear	4	15	140°		
	GaP	568		4	15			
KP-23ESGC	GaAsP/GaP	625	water clear	7	20	120°		3.0mm x 2.4mm x 1.05mm   
	GaP	568		7	20			
KP-23YSGC	GaAsP/GaP	588	water clear	2.6	8	120°		
	GaP	568		7	20			

NOTE:
1.KP series custom-made is available upon request.

MULTI-COLOR SMD LED

PART NUMBER	MATERIAL	λD (nm)	LENS TYPE	Iv (mcd) @20mA		VIEWING ANGLE 2θ1/2	DIMENSION
				MIN.	TYP.		
KPBL-3025ESGC	GaAsP/GaP	625	water clear	4	15	120°	<p>3.0mm x 2.5mm x 1.1mm (1109 Bi-Color)</p>
	GaP	568		4	15		
KPBL-3025EYC	GaAsP/GaP	625	water clear	4	15	120°	
	GaAsP/GaP	588		2.6	8		
KPBL-3025SRSGC-PRV	GaAlAs	640	water clear	36	100	120°	
	GaP	568		4	15		
KPBL-3025SRCGKC-PRV	GaAlAs	640	water clear	36	100	120°	
	AlGaInP	570		18	50		
KPBL-3025NSGC	GaAsP/GaP	610	water clear	4	15	120°	
	GaP	568		4	15		
KPBL-3025SURKCGKC	AlGaInP	630	water clear	70	220	120°	
	AlGaInP	570		18	50		
KPBL-3025YSGC	GaAsP/GaP	588	water clear	2.6	8	120°	
	GaP	568		4	15		
KPBL-3025QBDSYKC	InGaIn	470	water clear	36	80	120°	
	AlGaInP	590		50	200		
KPBL-3025ESGC	GaAsP/GaP	625	water clear	7	20	100°	<p>3.0mm x 2.5mm x 1.4mm (1109 Bi-Color)</p>
	GaP	568		7	20		
KPBL-3025EYC	GaAsP/GaP	625	water clear	7	20	100°	
	GaAsP/GaP	588		4	15		
KPBL-3025SRSGC-PRV	GaAlAs	640	water clear	36	100	100°	
	GaP	568		7	20		
KPBL-3025NSGC	GaAsP/GaP	610	water clear	7	20	100°	
	GaP	568		7	20		
KPBL-3025SURKCGKC	AlGaInP	630	water clear	180	500	100°	
	AlGaInP	570		50	150		
KPBL-3025YSGC	GaAsP/GaP	588	water clear	4	15	100°	
	GaP	568		7	20		
KPBL-3025QBDSYKC	InGaIn	470	water clear	50	180	100°	
	AlGaInP	590		70	150		
KPBD-3224ESGC	GaAsP/GaP	625	water clear	18	60	20°	<p>3.2mm x 2.4mm x 2.4mm (Dome Lens)</p>
	GaP	568		10	60		
KPBD-3224SURKSGC	AlGaInP	630	water clear	380	1200	20°	
	GaP	568		10	60		
KPBD-3224SURKCGKC	AlGaInP	630	water clear	380	1200	20°	
	AlGaInP	570		110	300		
KPBD-3224YSGC	GaAsP/GaP	588	water clear	4	15	20°	
	GaP	568		10	60		
KPBD-3224SYKCGKC	AlGaInP	590	water clear	110	500	20°	
	AlGaInP	570		110	300		





NOTE:
1.KP series custom-made is available upon request.

MULTI-COLOR SMD LED

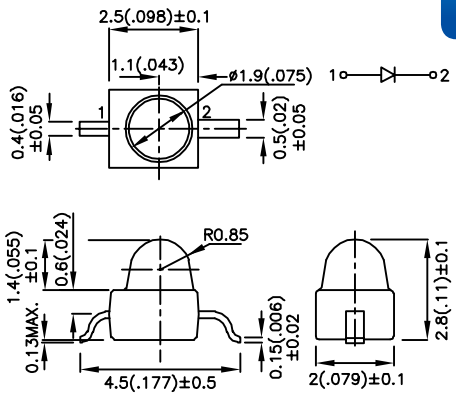

PART NUMBER	MATERIAL	λ_D (nm)	LENS TYPE	Iv (mcd) @20mA		VIEWING ANGLE 2 θ 1/2	DIMENSION
				MIN.	TYP.		
KA-2735ESGCT	GaAsP/GaP	625	water clear	7	30	120°	2.7mm x 3.5mm (Bi-Color)
	GaP	568		7	30		
KA-2735SURKMCT	AlGaInP	630	water clear	70	200	120°	
	AlGaInP	570		50	90		
KAA-3528SURKSYKCT	AlGaInP	630	water clear	110	350	120°	3.5mm x 2.8mm KAA-3528SURKSYKCT KAA-3528SURKCGKCT
	AlGaInP	590		70	250		
KAA-3528SURKCGKCT	AlGaInP	630	water clear	110	350	120°	
	AlGaInP	570		36	100		
KAA-3528SURKZGQBDCT	AlGaInP	630	water clear	110	350	120°	
	InGaN	525		380	600		
	InGaN	470		36	80		

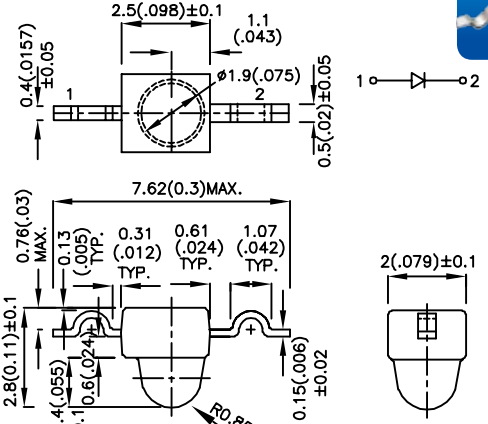
PART NUMBER	MATERIAL	λ_D (nm)	LENS TYPE	Iv (mcd) @30mA *50mA		VIEWING ANGLE 2 θ 1/2	DIMENSION
				MIN.	TYP.		
KAAF-5060QBDSURKZGCT	InGaN	470	water clear	110	250	100°	5.0mm x 6.0 mm x 2.3mm
	AlGaInP	630		*180	*350		
	InGaN	525		280	650		
KAAF-5060QBFSEEZGCT	InGaN	465	water clear	180	350	100°	
	AlGaInP	621		*650	*1000		
	InGaN	525		280	650		

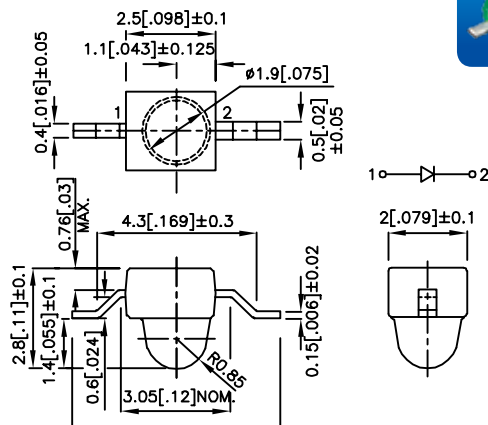
SUBMINIATURE SMD LED

PART NUMBER	MATERIAL	λ_D (nm)	LENS TYPE	Iv (mcd) @20mA		VIEWING ANGLE 2 θ 1/2	DIMENSION	
				MIN.	TYP.			
KM2520SURCK03	AlGaInP	630	water clear	900	2400	20°	Subminiature Solid State Lamps Gull Wing Lead   <p>Units : mm(inch) Tolerance : ±0.25(0.01)</p>	
KM2520SECK03	AlGaInP	601	water clear	900	2500	20°		
KM2520SYCK03	AlGaInP	590	water clear	900	2200	20°		
KM2520MGC03	AlGaInP	570	water clear	380	900	20°		
KM2520CGCK03	AlGaInP	570	water clear	280	700	20°		
KM2520ZGC03	InGaN	525	water clear	1200	2500	20°		
KM2520ZGC-E03	InGaN	525	water clear	2200	4000	20°		
KM2520ZGC-G03	InGaN	525	water clear	2800	5000	20°		
KM2520QBC-D03	InGaN	470	water clear	180	500	20°		
KM2520QBC-F03	InGaN	465	water clear	480	850	20°		
KM2520QBC-G03	InGaN	465	water clear	650	1300	20°		
KM2520SURCK08	AlGaInP	630	water clear	900	2400	20°		Subminiature Solid State Lamps Yoke Lead   <p>Units : mm(inch) Tolerance : ±0.25(0.01)</p>
KM2520SECK08	AlGaInP	601	water clear	900	2500	20°		
KM2520SYCK08	AlGaInP	590	water clear	900	2200	20°		
KM2520MGC08	AlGaInP	570	water clear	380	900	20°		
KM2520CGCK08	AlGaInP	570	water clear	280	700	20°		
KM2520ZGC08	InGaN	525	water clear	1200	2500	20°		
KM2520ZGC-E08	InGaN	525	water clear	2200	4000	20°		
KM2520ZGC-G08	InGaN	525	water clear	2800	5000	20°		
KM2520QBC-D08	InGaN	470	water clear	180	500	20°		
KM2520QBC-F08	InGaN	465	water clear	480	850	20°		
KM2520QBC-G08	InGaN	465	water clear	650	1300	20°		
KM2520SURCK09	AlGaInP	630	water clear	900	2400	20°	Subminiature Solid State Lamps Z-Bend Lead   <p>Units : mm(inch) Tolerance : ±0.25(0.01)</p>	
KM2520SECK09	AlGaInP	601	water clear	900	2500	20°		
KM2520SYCK09	AlGaInP	590	water clear	900	2200	20°		
KM2520MGC09	AlGaInP	570	water clear	380	900	20°		
KM2520CGCK09	AlGaInP	570	water clear	280	700	20°		
KM2520ZGC09	InGaN	525	water clear	1200	2500	20°		
KM2520ZGC-E09	InGaN	525	water clear	2200	4000	20°		
KM2520ZGC-G09	InGaN	525	water clear	2800	5000	20°		
KM2520QBC-D09	InGaN	470	water clear	180	500	20°		
KM2520QBC-F09	InGaN	465	water clear	480	850	20°		
KM2520QBC-G09	InGaN	465	water clear	650	1300	20°		

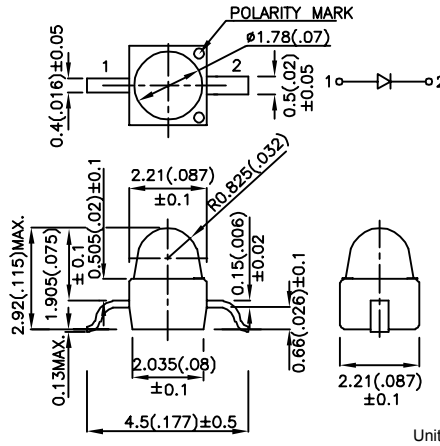
SUBMINIATURE SMD LED

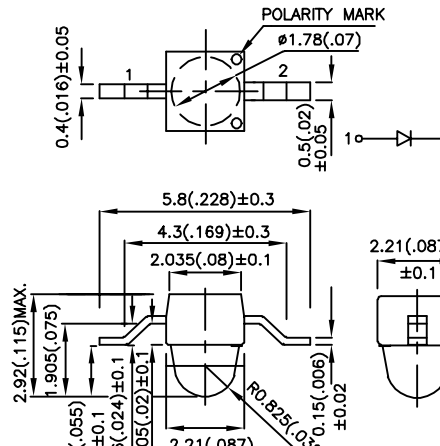
PART NUMBER	MATERIAL	λ_D (nm)	LENS TYPE	Iv (mcd) @20mA		VIEWING ANGLE	DIMENSION	
				MIN.	TYP.			
KM-27SURCK-03	AlGaInP	630	water clear	900	2400	20°	<p>Subminiature Solid State Lamps Gull Wing Lead</p>   <p>Units : mm(inch) Tolerance : ±0.25(0.01)</p>	
KM-27SECK-03	AlGaInP	601	water clear	900	2500	20°		
KM-27SYCK-03	AlGaInP	590	water clear	900	2200	20°		
KM-27MGC-03	AlGaInP	570	water clear	380	900	20°		
KM-27CGCK-03	AlGaInP	570	water clear	280	700	20°		
KM-27ZGC-03	InGaN	525	water clear	1200	2500	20°		
KM-27ZGC-E-03	InGaN	525	water clear	2200	4000	20°		
KM-27ZGC-G-03	InGaN	525	water clear	2800	5000	20°		
KM-27QBC-D-03	InGaN	470	water clear	180	500	20°		
KM-27QBC-F-03	InGaN	465	water clear	480	850	20°		
KM-27QBC-G-03	InGaN	465	water clear	650	1300	20°		
KM-27SURCK-09	AlGaInP	630	water clear	900	2400	20°		<p>Subminiature Solid State Lamps Z-Bend Lead</p>   <p>Units : mm(inch) Tolerance : ±0.25(0.01)</p>
KM-27SECK-09	AlGaInP	601	water clear	900	2500	20°		
KM-27SYCK-09	AlGaInP	590	water clear	900	2200	20°		
KM-27MGC-09	AlGaInP	570	water clear	380	900	20°		
KM-27CGCK-09	AlGaInP	570	water clear	280	700	20°		
KM-27ZGC-09	InGaN	525	water clear	1200	2500	20°		
KM-27ZGC-E-09	InGaN	525	water clear	2200	4000	20°		
KM-27ZGC-G-09	InGaN	525	water clear	2800	5000	20°		
KM-27QBC-D-09	InGaN	470	water clear	180	500	20°		
KM-27QBC-F-09	InGaN	465	water clear	480	850	20°		
KM-27QBC-G-09	InGaN	465	water clear	650	1300	20°		

REVERSE MOUNT SMD LED

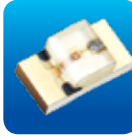
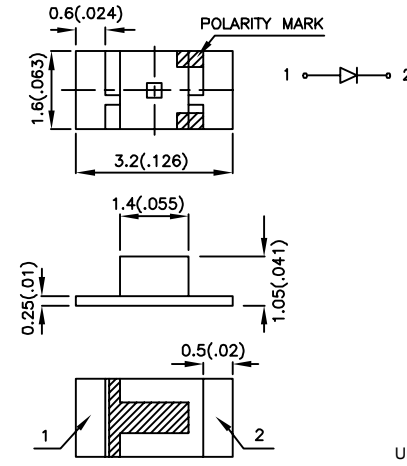
PART NUMBER	MATERIAL	λ_D (nm)	LENS TYPE	Iv (mcd) @20mA		VIEWING ANGLE 2 θ 1/2	DIMENSION
				MIN.	TYP.		
KPTR-3216SURCK	AlGaInP	630	water clear	70	220	120°	3.2mm x 1.6mm x 1.05mm (1206 Reverse Mount)  KPTR-3216  Units : mm(inch) Tolerance : ±0.2(0.008)
KPTR-3216SECK	AlGaInP	601	water clear	70	240	120°	
KPTR-3216SYCK	AlGaInP	590	water clear	50	150	120°	
KPTR-3216MGC	AlGaInP	570	water clear	36	70	120°	
KPTR-3216CGCK	AlGaInP	570	water clear	10	50	120°	
KPTR-3216ZGC	InGaIn	525	water clear	110	300	120°	
KPTR-3216ZGC-E	InGaIn	525	water clear	280	650	120°	
KPTR-3216ZGC-G	InGaIn	525	water clear	380	700	120°	
KPTR-3216QBC-D	InGaIn	470	water clear	36	100	120°	
KPTR-3216QBC-F	InGaIn	465	water clear	50	150	120°	
KPTR-3216QBC-G	InGaIn	465	water clear	70	180	120°	

NOTE:
1.KP series custom-made is available upon request.

SOT-23 SMD LED

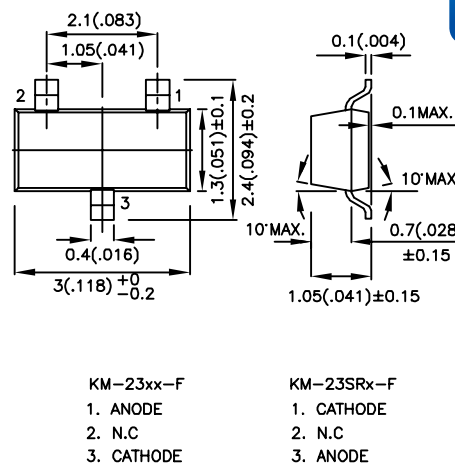
PART NUMBER	MATERIAL	λ_D (nm)	LENS TYPE	Iv (mcd) @20mA		VIEWING ANGLE 2 θ 1/2	DIMENSION
				MIN.	TYP.		
KM-23ID-F	GaAsP/GaP	625	red diffused	4	12	140°	SOT-23 Surface Mount LED Lamp (3mm x 1.3mm)  KM-23-F  Units : mm(inch) Tolerance : ±0.25(0.01)
KM-23EC-F	GaAsP/GaP	625	water clear	4	15	140°	
KM-23SRD-F	GaAlAs	640	red diffused	36	70	140°	
KM-23SRC-F	GaAlAs	640	water clear	36	90	140°	
KM-23YD-F	GaAsP/GaP	588	yellow diffused	2.6	8.5	140°	
KM-23YC-F	GaAsP/GaP	588	water clear	2.6	10	140°	
KM-23SYD-F	AlGaInP	590	yellow diffused	50	100	140°	
KM-23SYC-F	AlGaInP	590	water clear	50	150	140°	
KM-23SGD-F	GaP	568	green diffused	2.6	8	140°	
KM-23SGC-F	GaP	568	water clear	4	15	140°	
KM-23CGCK-F	AlGaInP	570	water clear	18	50	140°	
KM-23ZGC-F	InGaIn	525	water clear	70	250	140°	
KM-23ZGC-E-F	InGaIn	525	water clear	110	450	140°	
KM-23ZGC-G-F	InGaIn	525	water clear	280	500	140°	
KM-23QBC-D-F	InGaIn	470	water clear	36	80	140°	
KM-23QBC-F-F	InGaIn	465	water clear	50	100	140°	
KM-23QBC-G-F	InGaIn	465	water clear	70	140	140°	

AMBIENT LIGHT SENSOR

PART NUMBER

KPS-3227SP1C

ELECTRICAL AND RADIANT CHARACTERISTICS (T_A =25°C,UNLESS OTHERWISE SPECIFIED)

PARAMETER	SYMBOL	MIN.	TYP.	MAX.	UNIT	TEST CONDITION
Collector Emitter Breakdown Voltage	BV _{ceo}	60	-	-	V	I _{ceo} =100μA
Emitter Collector Breakdown Voltage	BV _{eco}	4	-	-	V	I _{eco} =100μA
Collector Dark Current	I _D	-	10	100	nA	V _{CE} =5V E _V =0Lx
Angle Of half Sensitivity	2θ1/2	-	120	-	°	-
Light Current(1)	I _{PH1}	-	6	-	μA	V _{CE} =5V,E _V =100 Lx ^[1]
Light Current(2)	I _{PH2}	-	130	-	μA	V _{CE} =5V,E _V =1000 Lx ^[1]
Light Current(3)	I _{PH3}	-	950	-	μA	V _{CE} =5V,E _V =10000 Lx ^[2]
Light Current(4)	I _{PH4}	-	420	-	μA	V _{CE} =5V,E _V =1000 Lx ^[3]
Saturation Output Voltage	V _o	4.5	4.7	-	V	V _{CC} =5V,E _V =1000Lx ^[1] , R _L =75KΩ
Peak Wavelength	λ _P	-	580	-	nm	-
Response Wavelength	λ	390	-	700	nm	>10% Response
Collector Emitter Saturation Voltage	V _{CE(sat)}	-	-	0.4	V	I _C =10 mA

Notes:

- 1.White Fluorescent light (Color Temperature = 6200K) is used as light source.
- 2.Illuminance by CIE standard illuminant-A/2856K,incandescet lamp.
- 3.Sunlight (Color Temperature = 4600K) is used as light source.

DIMENSION

KPS-3227SP1C 3.2mm x 2.7mm x 1.1mm
(AMBIENT LIGHT SENSOR)



KPS-3227SP1C

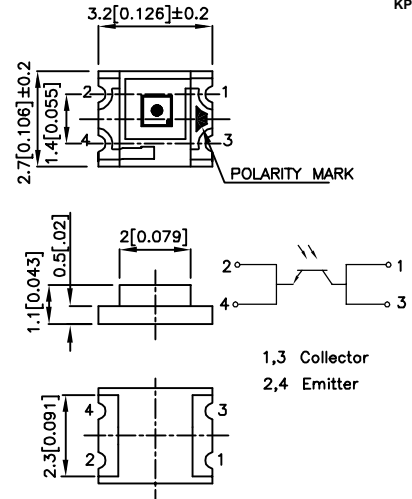

1,3 Collector
2,4 Emitter

Units : mm(inch)
Tolerance : ±0.1(0.004)

COLOR SENSOR

PART NUMBER

KPS-5130PD7C

ELECTRICAL AND RADIANT CHARACTERISTICS (T_A =25°C,UNLESS OTHERWISE SPECIFIED)

PARAMETER	SYMBOL	CONDITION	MIN.	TYP.	MAX.	UNIT	
Peak Sensitivity Wavelength	λ _P	Red	-	620	-	nm	
		Green	-	550	-		
		Blue	-	470	-		
Light Current (1)	I _{L1}	100Lux [1] VR =5V	Red	-	0.039	μA	
			Green	-	0.042		-
			Blue	-	0.022		-
Light Current (2)	I _{L2}	1000Lux [1] VR =5V	Red	-	0.427	V	
			Green	-	0.498		-
			Blue	-	0.262		-
Diameter of the irradiation sensitive area	D		-	2.0	-	mm	
Irradiation sensitive area per element	A		-	0.85	-	mm ²	
Photo sensibility of the single color areas	S _{Max}	λ R=620 nm λ G=550 nm λ B=470 nm		0.33	-	A/W	
				0.25	-		
				0.18	-		
Reverse Dark Current	I _D	VR =5V	-	-	10	nA	

Note:

- 1.White fluorescent light (Color Temperature = 6500K) is used as light source.

DIMENSION

KPS-5130PD7C 5.12mm x 3mm x 1.1mm
(RGB COLOR SENSOR)



KPS-5130PD7C

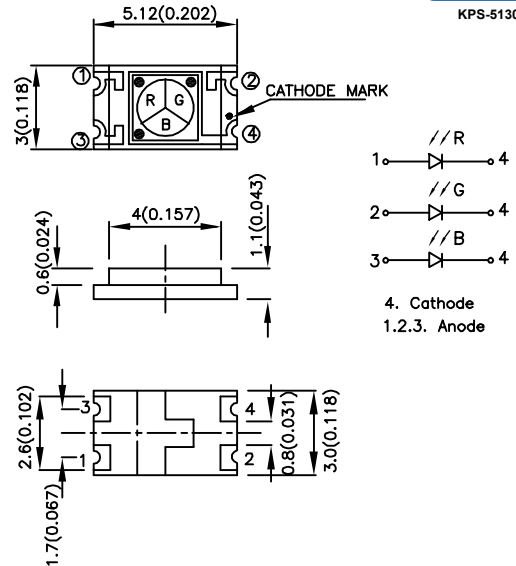

1 // R
2 // G
3 // B
4. Cathode
1,2,3. Anode

Units : mm(inch)
Tolerance : ±0.1(0.004)

Kingbright

Optoelectronic Components





Through-Hole LED **27**

Subminiature LED	27
Round LED	27
Oval LED	31
Flat Top LED	32
Rectangular LED	32
Cylindrical LED	35
Multi-Color LED	35
Low Current LED	39
Blinking LED	40
Resistor LED	40
Super Flux LED	41
Side View	42
Tape and Reel Selections	43

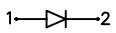
SUBMINIATURE LED



PART NUMBER	MATERIAL	λ_D (nm)	LENS TYPE	Iv (mcd) @20mA		VIEWING ANGLE 2 θ 1/2	DIMENSION
				MIN.	TYP.		
KM2520SURCK01	AlGaInP	630	water clear	900	2400	20°	Subminiature Solid State Lamps  KM2520xxx01 
KM2520SECK01	AlGaInP	601	water clear	900	2500	20°	
KM2520SYCK01	AlGaInP	590	water clear	900	2200	20°	
KM2520MGC01	AlGaInP	570	water clear	380	900	20°	
KM2520CGCK01	AlGaInP	570	water clear	280	700	20°	
KM2520ZGC01	InGaIn	525	water clear	1200	2500	20°	
KM2520ZGC-E01	InGaIn	525	water clear	2200	4000	20°	
KM2520ZGC-G01	InGaIn	525	water clear	2800	5000	20°	
KM2520QBC-D01	InGaIn	470	water clear	180	500	20°	
KM2520QBC-F01	InGaIn	465	water clear	480	850	20°	
KM2520QBC-G01	InGaIn	465	water clear	650	1300	20°	

ROUND LED

PART NUMBER	MATERIAL	λ_D (nm)	LENS TYPE	Iv (mcd) @10mA *20mA		VIEWING ANGLE 2 θ 1/2	DIMENSION
				MIN.	TYP.		
L-2060ID	GaAsP/GaP	625	red diffused	8	15	70°	1.8mm Round  L-2060
L-2060SRD	GaAlAs	640	red diffused	*70	*200	70°	
L-2060SRC	GaAlAs	640	water clear	*110	*300	30°	
L-2060ED	GaAsP/GaP	625	orange diffused	8	15	70°	
L-2060YD	GaAsP/GaP	588	yellow diffused	5	8	70°	
L-2060GD	GaP	568	green diffused	5	10	70°	
L-1154ID	GaAsP/GaP	625	red diffused	8	25	60°	T-1 (3mm) Round  L-1154
L-1154IT	GaAsP/GaP	625	red transparent	18	60	50°	
L-1154ND	GaAsP/GaP	610	orange diffused	8	30	60°	
L-1154NT	GaAsP/GaP	610	orange transparent	18	50	50°	
L-1154YD	GaAsP/GaP	588	yellow diffused	5	15	60°	
L-1154YT	GaAsP/GaP	588	yellow transparent	8	20	50°	
L-1154GD	GaP	568	green diffused	8	15	60°	T-1 (3mm) Round  L-132X
L-1154GT	GaP	568	green transparent	18	40	50°	
L-1154PGD	GaP	555	green diffused	1.8	5	60°	
L-1154PGT	GaP	555	green transparent	3	10	50°	
L-132XID	GaAsP/GaP	625	red diffused	8	25	60°	
L-132XIT	GaAsP/GaP	625	red transparent	18	60	50°	
L-132XND	GaAsP/GaP	610	orange diffused	8	30	60°	
L-132XNT	GaAsP/GaP	610	orange transparent	18	50	50°	
L-132XNC	GaAsP/GaP	610	water clear	18	50	50°	
L-132XYD	GaAsP/GaP	588	yellow diffused	5	15	60°	
L-132XYT	GaAsP/GaP	588	yellow transparent	8	20	50°	
L-132XYS	GaAsP/GaP	588	water clear	8	20	50°	
L-132XGD	GaP	568	green diffused	8	15	60°	
L-132XGT	GaP	568	green transparent	12	40	50°	
L-132XGC	GaP	568	water clear	12	40	50°	
L-132XPGD	GaP	555	green diffused	1.8	5	60°	
L-132XPGT	GaP	555	green transparent	3	10	50°	
L-132XPGC	GaP	555	water clear	3	10	50°	

NOTES:
 1. All dimensions are in millimeters (inches).
 2. Tolerance is $\pm 0.25\text{mm}$ (0.01") unless otherwise noted.

ROUND LED

PART NUMBER	MATERIAL	λ_D (nm)	LENS TYPE	Iv (mcd) @10mA *20mA		VIEWING ANGLE	DIMENSION
				MIN.	TYP.		
L-7104ID	GaAsP/GaP	625	red diffused	8	20	40°	T-1 (3mm) Round  L-7104
L-7104IT	GaAsP/GaP	625	red transparent	18	60	34°	
L-7104EC	GaAsP/GaP	625	water clear	18	60	34°	
L-7104ED	GaAsP/GaP	625	orange diffused	8	20	40°	
L-7104ND	GaAsP/GaP	610	orange diffused	8	30	40°	
L-7104NT	GaAsP/GaP	610	orange transparent	18	50	34°	
L-7104NC	GaAsP/GaP	610	water clear	18	50	34°	
L-7104YD	GaAsP/GaP	588	yellow diffused	5	15	40°	
L-7104YT	GaAsP/GaP	588	yellow transparent	8	30	34°	
L-7104YC	GaAsP/GaP	588	water clear	8	30	34°	
L-7104GD	GaP	568	green diffused	8	20	40°	
L-7104GT	GaP	568	green transparent	18	60	34°	
L-7104GC	GaP	568	water clear	18	60	34°	
L-7104PGD	GaP	555	green diffused	1.8	5	40°	
L-7104PGT	GaP	555	green transparent	3	15	34°	
L-7104PGC	GaP	555	water clear	3	15	34°	
L-7104SRC-D	GaAlAs	640	water clear	*480	*600	34°	
L-7104SRC-E	GaAlAs	640	water clear	*650	*800	34°	
L-7104SRD-D	GaAlAs	640	red diffused	*110	*150	40°	
L-7104SRD-E	GaAlAs	640	red diffused	*180	*250	40°	
L-7104SRD-F	GaAlAs	640	red diffused	*280	*350	40°	
L-7104SURC-E	AlGaInP	630	water clear	*900	*1300	34°	
L-7104SECK	AlGaInP	601	water clear	*280	*900	34°	
L-7104SETK	AlGaInP	601	orange transparent	*280	*650	34°	
L-7104SEDK	AlGaInP	601	orange diffused	*180	*350	40°	
L-7104SEC-E	AlGaInP	621	water clear	*900	*2000	34°	
L-7104SEC-H	AlGaInP	630	water clear	*1800	*3500	34°	
L-7104SYCK	AlGaInP	590	water clear	*380	*1300	34°	
L-7104SYTK	AlGaInP	590	yellow transparent	*280	*700	34°	
L-7104SYDK	AlGaInP	590	yellow diffused	*70	*150	40°	
L-7104SYC-H	AlGaInP	589	water clear	*650	*2000	34°	
L-7104SGC	GaP	568	water clear	*70	*150	34°	
L-7104SGD	GaP	568	green diffused	*18	*40	40°	
L-7104CGCK	AlGaInP	570	water clear	*110	*350	34°	
L-7104ZGC	InGaN	525	water clear	*2800	*6500	34°	
L-7104ZGC-E	InGaN	525	water clear	*3800	*6800	34°	
L-7104QBC-D	InGaN	470	water clear	*650	*1500	20°	
L-7104QBC-F	InGaN	465	water clear	*1000	*1800	20°	
L-7104QBC-G	InGaN	465	water clear	*1100	*2300	20°	
L-34HD	GaP	660	red diffused	1	3	60°	T-1 (3mm) Round  L-34
L-34ID	GaAsP/GaP	625	red diffused	8	25	60°	
L-34YD	GaAsP/GaP	588	yellow diffused	1.8	6	60°	
L-34AD	GaAsP/GaP	588	amber diffused	3	12	60°	
L-34GD	GaP	568	green diffused	5	20	60°	
L-174XHT	GaP	660	red transparent	1.8	5	35°	3.2mm Round  L-174X
L-174XIT	GaAsP/GaP	625	red transparent	8	30	35°	
L-174XSRT	GaAlAs	640	red transparent	*110	*400	35°	
L-174XYT	GaAsP/GaP	588	yellow transparent	8	30	35°	
L-174XGT	GaP	568	green transparent	8	30	35°	

NOTES:





1. All dimensions are in millimeters (inches).
2. Tolerance is $\pm 0.25\text{mm}$ (0.01") unless otherwise noted.

ROUND LED

PART NUMBER	MATERIAL	λD (nm)	LENS TYPE	Iv (mcd) @10mA *20mA		VIEWING ANGLE	DIMENSION
				MIN.	TYP.		
L-174A2HT	GaP	660	red transparent	1.8	6	35°	3.2mm Round
L-174A2IT	GaAsP/GaP	625	red transparent	28	90	35°	
L-174A2SRT	GaAlAs	640	red transparent	*380	*900	35°	
L-174A2YT	GaAsP/GaP	588	yellow transparent	18	35	35°	
L-174A2GT	GaP	568	green transparent	12	40	35°	
L-43HD	GaP	660	red diffused	0.7	2	80°	4mm Round
L-43ID	GaAsP/GaP	625	red diffused	5	15	80°	
L-43YD	GaAsP/GaP	588	yellow diffused	3	10	80°	
L-43GD	GaP	568	green diffused	3	12	80°	
L-7113ID	GaAsP/GaP	625	red diffused	8	45	30°	T-1 3/4 (5mm) Round
L-7113IT	GaAsP/GaP	625	red transparent	28	80	20°	
L-7113ED	GaAsP/GaP	625	orange diffused	8	25	30°	
L-7113EC	GaAsP/GaP	625	water clear	28	80	20°	
L-7113ND	GaAsP/GaP	610	orange diffused	12	30	30°	
L-7113NT	GaAsP/GaP	610	orange transparent	40	80	20°	
L-7113NC	GaAsP/GaP	610	water clear	40	80	20°	
L-7113YD	GaAsP/GaP	588	yellow diffused	5	20	30°	
L-7113YT	GaAsP/GaP	588	yellow transparent	18	40	20°	
L-7113YC	GaAsP/GaP	588	water clear	18	40	20°	
L-7113GD	GaP	568	green diffused	5	20	30°	
L-7113GT	GaP	568	green transparent	18	60	20°	
L-7113GC	GaP	568	water clear	18	60	20°	
L-7113PGD	GaP	555	green diffused	1.8	5	30°	
L-7113PGT	GaP	555	green transparent	5	10	20°	
L-7113PGC	GaP	555	water clear	5	10	20°	
L-7113SRC-DU	GaAlAs	640	water clear	*900	*1100	20°	
L-7113SRC-DV	GaAlAs	640	water clear	*1200	*1400	20°	
L-7113SRC-DW	GaAlAs	640	water clear	*1500	*1700	20°	
L-7113SRD-D	GaAlAs	640	red diffused	*180	*250	30°	
L-7113SRD-E	GaAlAs	640	red diffused	*280	*400	30°	
L-7113SRD-F	GaAlAs	640	red diffused	*480	*600	30°	
L-7113SURC	AlGainP	630	water clear	*1200	*1400	20°	
L-7113SURC-E	AlGainP	630	water clear	*1500	*2200	20°	
L-7113SECK	AlGainP	601	water clear	*650	*2400	20°	
L-7113SETK	AlGainP	601	orange transparent	*650	*2400	20°	
L-7113SEDK	AlGainP	601	orange diffused	*280	*600	30°	
L-7113SEC-E	AlGainP	621	water clear	*1500	*5000	20°	
L-7113SEC-H	AlGainP	630	water clear	*3800	*10000	20°	
L-7113SYCK	AlGainP	590	water clear	*480	*1800	20°	
L-7113SYTK	AlGainP	590	yellow transparent	*480	*1000	20°	
L-7113SYDK	AlGainP	590	yellow diffused	*110	*380	30°	
L-7113SYC-H	AlGainP	589	water clear	*1500	*3300	20°	
L-7113SGC	GaP	568	water clear	*70	*200	20°	
L-7113SGD	GaP	568	green diffused	*18	*40	30°	
L-7113CGCK	AlGainP	570	water clear	*480	*1200	20°	
L-7113ZGC	InGaN	525	water clear	*3800	*6500	20°	
L-7113ZGC-E	InGaN	525	water clear	*7500	*15000	20°	
L-7113QBC-D	InGaN	470	water clear	*900	*2200	16°	
L-7113QBC-F	InGaN	465	water clear	*1800	*3300	16°	
L-7113QBC-G	InGaN	465	water clear	*2200	*4000	16°	

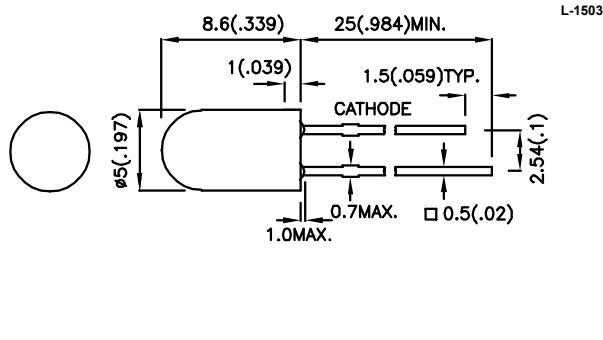
NOTES:
 1. All dimensions are in millimeters(inches).
 2. Tolerance is ±0.25mm(0.01") unless otherwise noted.

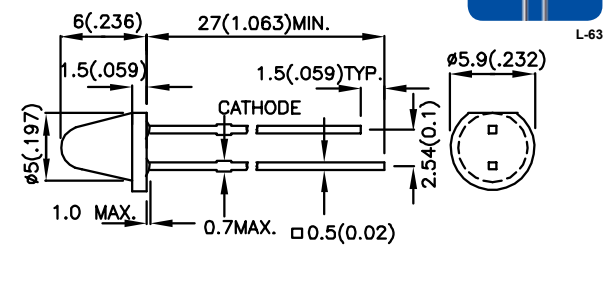
ROUND LED

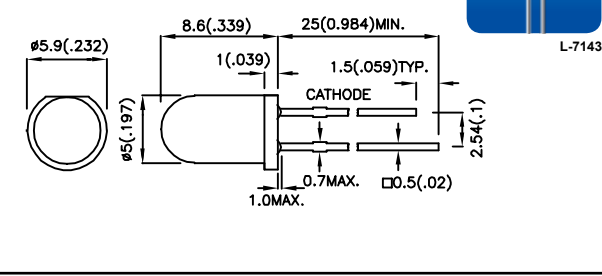
PART NUMBER	MATERIAL	λ_D (nm)	LENS TYPE	Iv (mcd) @10mA *20mA		VIEWING ANGLE 2 θ 1/2	DIMENSION
				MIN.	TYP.		
L-1503ID	GaAsP/GaP	625	red diffused	8	30	60°	T-1 3/4 (5mm) Round  
L-1503IT	GaAsP/GaP	625	red transparent	28	80	30°	
L-1503EC	GaAsP/GaP	625	water clear	28	80	30°	
L-1503SRD	GaAlAs	640	red diffused	*380	*700	60°	
L-1503SRC-D	GaAlAs	640	water clear	*900	*1500	30°	
L-1503YD	GaAsP/GaP	588	yellow diffused	5	20	60°	
L-1503YT	GaAsP/GaP	588	yellow transparent	18	40	30°	
L-1503YC	GaAsP/GaP	588	water clear	18	40	30°	
L-1503GD	GaP	568	green diffused	5	20	60°	
L-1503GT	GaP	568	green transparent	18	60	30°	
L-1503GC	GaP	568	water clear	18	60	30°	
L-1503SGT	GaP	568	green transparent	*70	*150	30°	
L-1503SGC	GaP	568	water clear	*70	*200	30°	
L-1513IT	GaAsP/GaP	625	red transparent	40	80	20°	
L-1513EC	GaAsP/GaP	625	water clear	40	80	20°	
L-1513SURC	AlGaInP	630	water clear	*1200	*1800	20°	
L-1513SURC-E	AlGaInP	630	water clear	*1500	*2200	20°	
L-1513YT	GaAsP/GaP	588	yellow transparent	18	40	20°	
L-1513YC	GaAsP/GaP	588	water clear	18	40	20°	
L-1513GT	GaP	568	green transparent	18	50	20°	
L-1513GC	GaP	568	water clear	18	50	20°	
L-63ID	GaAsP/GaP	625	red diffused	12	20	60°	T-1 3/4 (5mm) Round  
L-63IT	GaAsP/GaP	625	red transparent	28	50	30°	
L-63SRD	GaAlAs	640	red diffused	*110	*300	60°	
L-63SRT	GaAlAs	640	red transparent	*280	*600	30°	
L-63SRC	GaAlAs	640	water clear	*180	*700	30°	
L-63YD	GaAsP/GaP	588	yellow diffused	1.8	6	60°	
L-63YT	GaAsP/GaP	588	yellow transparent	18	35	30°	
L-63GD	GaP	568	green diffused	5	12	60°	
L-63GT	GaP	568	green transparent	18	40	30°	
L-7143SRC-C	GaAlAs	640	water clear	*380	*600	30°	T-1 3/4 (5mm) Round  
L-7143SRC-D	GaAlAs	640	water clear	*650	*900	30°	
L-7143SGC	GaP	568	water clear	*70	*150	30°	

NOTES:

1. All dimensions are in millimeters (inches).
2. Tolerance is $\pm 0.25\text{mm}$ (0.01") unless otherwise noted.

ROUND LED

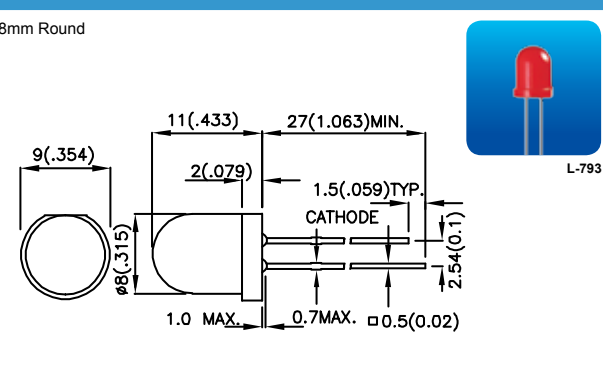
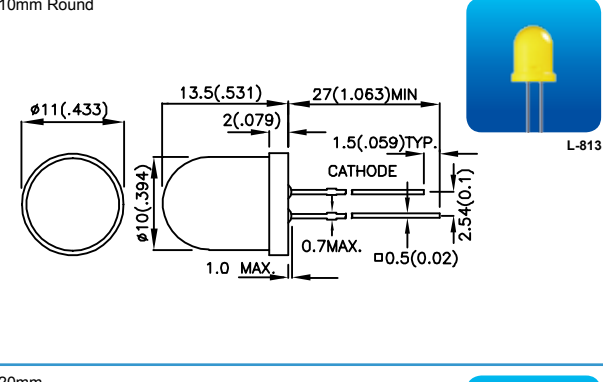
PART NUMBER	MATERIAL	λ_D (nm)	LENS TYPE	Iv (mcd) @10mA *20mA		VIEWING ANGLE 2 θ 1/2	DIMENSION
				MIN.	TYP.		
L-793ID	GaAsP/GaP	625	red diffused	*36	*100	30°	8mm Round 
L-793SRC-D	GaAlAs	640	water clear	*1500	*1700	15°	
L-793SRC-E	GaAlAs	640	water clear	*1800	*2700	15°	
L-793SRD-C	GaAlAs	640	red diffused	*180	*250	30°	
L-793SRD-D	GaAlAs	640	red diffused	*280	*350	30°	
L-793SRD-E	GaAlAs	640	red diffused	*380	*450	30°	
L-793ED	GaAsP/GaP	625	orange diffused	*36	*100	30°	
L-793YD	GaAsP/GaP	588	yellow diffused	*18	*50	30°	
L-793GD	GaP	568	green diffused	*18	*60	30°	
L-813ID	GaAsP/GaP	625	red diffused	*36	*100	30°	10mm Round 
L-813SRC-D	GaAlAs	640	water clear	*1500	*1700	15°	
L-813SRD-C	GaAlAs	640	red diffused	*180	*250	30°	
L-813SRD-D	GaAlAs	640	red diffused	*280	*350	30°	
L-813SRD-E	GaAlAs	640	red diffused	*380	*450	30°	
L-813ED	GaAsP/GaP	625	orange diffused	*36	*100	30°	
L-813YD	GaAsP/GaP	588	yellow diffused	*10	*50	30°	
L-813GD	GaP	568	green diffused	*18	*60	30°	
DLA/6ID	GaAsP/GaP	625	red diffused	12	50	120°	
DLC/6ID	GaAsP/GaP	625	red diffused	12	50	120°	
DLA/6SRD	GaAlAs	640	red diffused	*110	*400	120°	
DLC/6SRD	GaAlAs	640	red diffused	*110	*400	120°	
DLA/6YD	GaAsP/GaP	588	yellow diffused	12	50	120°	
DLC/6YD	GaAsP/GaP	588	yellow diffused	12	50	120°	
DLA/6GD	GaP	568	green diffused	18	80	120°	
DLC/6GD	GaP	568	green diffused	18	80	120°	
DLA/6SGD	GaP	568	green diffused	*70	*200	120°	
DLC/6SGD	GaP	568	green diffused	*70	*200	120°	

OVAL LED

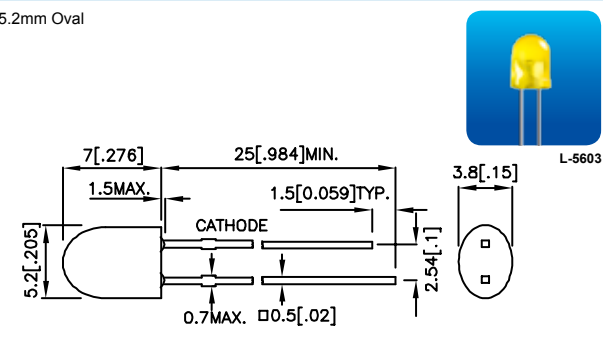
PART NUMBER	MATERIAL	λ_D (nm)	LENS TYPE	Iv (mcd) @20mA		VIEWING ANGLE 2 θ 1/2	DIMENSION
				MIN.	TYP.		
L-5603SIDL/SD-H	AlGaInP	630	red semi diffused	650	2500	100°(H) 50°(V)	5.2mm Oval 
L-5603SYDL/SD-H	AlGaInP	589	yellow semi diffused	380	750	100°(H) 50°(V)	
L-5603ZGDL/SD-E	InGaN	525	green semi diffused	1800	3100	100°(H) 50°(V)	
L-5603ZGDL/SD-G	InGaN	525	green semi diffused	2200	3500	100°(H) 50°(V)	
L-5603QBDL/SD-F	InGaN	465	blue semi diffused	380	1300	100°(H) 50°(V)	
L-5603QBDL/SD-G	InGaN	465	blue semi diffused	480	1500	100°(H) 50°(V)	

NOTES:

1. All dimensions are in millimeters (inches).
2. Tolerance is $\pm 0.25\text{mm}$ (0.01") unless otherwise noted.

FLAT TOP LED

PART NUMBER	MATERIAL	λ_D (nm)	LENS TYPE	Iv (mcd) @10mA		VIEWING ANGLE	DIMENSION
				MIN.	TYP.		
L-1394HDT	GaP	660	red diffused	0.4	1	120°	2mm Flat Top
L-1394IDT	GaAsP/GaP	625	red diffused	5	8	120°	
L-1394YDT	GaAsP/GaP	588	yellow diffused	1.8	5	120°	
L-1394GDT	GaP	568	green diffused	3	5	120°	
L-1034HDT	GaP	660	red diffused	0.4	1	70°	2mm Flat Top
L-1034IDT	GaAsP/GaP	625	red diffused	3	8	70°	
L-1034YDT	GaAsP/GaP	588	yellow diffused	1.8	5	70°	
L-1034GDT	GaP	568	green diffused	1.8	6	70°	
L-13HD	GaP	660	red diffused	0.4	1.5	70°	2mm Flat Top
L-13ID	GaAsP/GaP	625	red diffused	5	10	70°	
L-13YD	GaAsP/GaP	588	yellow diffused	3	8	70°	
L-13GD	GaP	568	green diffused	3	10	70°	





RECTANGULAR LED

PART NUMBER	MATERIAL	λ_D (nm)	LENS TYPE	Iv (mcd) @10mA		VIEWING ANGLE	DIMENSION
				MIN.	TYP.		
L-2774HD	GaP	660	red diffused	0.3	0.9	70°	1.75mm x 3.9mm Rectangular
L-2774ID	GaAsP/GaP	625	red diffused	3	12	70°	
L-2774ED	GaAsP/GaP	625	orange diffused	3	15	70°	
L-2774ND	GaAsP/GaP	610	orange diffused	3	13	70°	
L-2774YD	GaAsP/GaP	588	yellow diffused	1.8	7	70°	
L-2774GD	GaP	568	green diffused	1.8	9	70°	

NOTES:

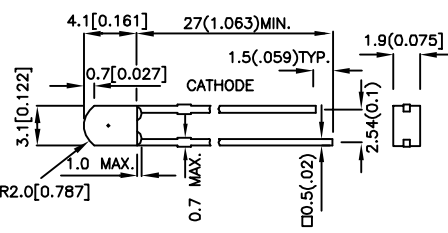
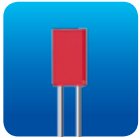
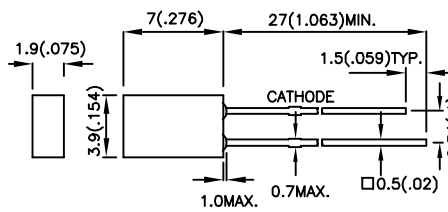
1. All dimensions are in millimeters(inches).
2. Tolerance is $\pm 0.25\text{mm}(0.01\text{'})$ unless otherwise noted.

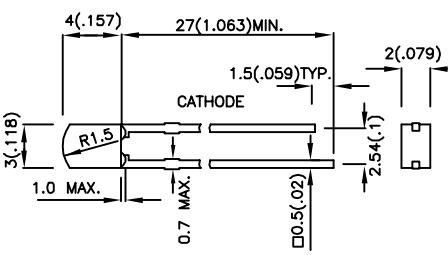
RECTANGULAR LED

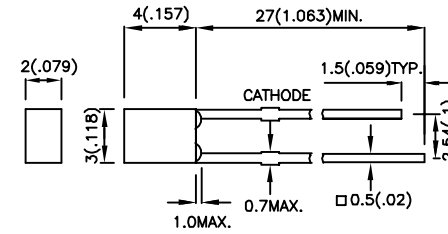
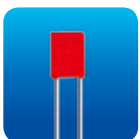
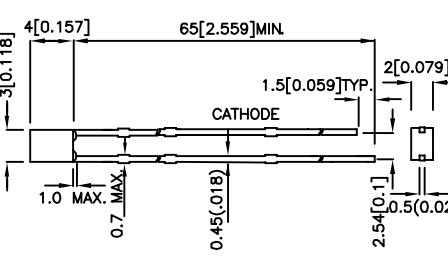
PART NUMBER	MATERIAL	λ_D (nm)	LENS TYPE	Iv (mcd) @10mA *20mA		VIEWING ANGLE 2 θ 1/2	DIMENSION
				MIN.	TYP.		
L-292XIT	GaAsP/GaP	625	red transparent	5	14	90°	1.9mm x 3.1mm Rectangular  
L-292XYD	GaAsP/GaP	588	yellow diffused	1.8	8	110°	
L-292XYT	GaAsP/GaP	588	yellow transparent	1.8	9	90°	
L-292XGD	GaP	568	green diffused	5	12	110°	
L-292XGT	GaP	568	green transparent	5	14	90°	
L-144HDT	GaP	660	red diffused	0.4	1	110°	1.9mm x 3.9mm Rectangular  
L-144IDT	GaAsP/GaP	625	red diffused	3	6	110°	
L-144EDT	GaAsP/GaP	625	orange diffused	3	6	110°	
L-144SRDT	GaAlAs	640	red diffused	*36	*70	110°	
L-144YDT	GaAsP/GaP	588	yellow diffused	1	3	110°	
L-144GDT	GaP	568	green diffused	1	4	110°	
L-2914ID	GaAsP/GaP	625	red diffused	3	10	50°	2mm x 3mm Rectangular  
L-2914YD	GaAsP/GaP	588	yellow diffused	5	13	50°	
L-2914GD	GaP	568	green diffused	5	15	50°	
L-914HDT	GaP	660	red diffused	0.2	1	100°	2mm x 3mm Rectangular  
L-914HT	GaP	660	red transparent	0.4	1	90°	
L-914IDT	GaAsP/GaP	625	red diffused	1.8	8	100°	
L-914IT	GaAsP/GaP	625	red transparent	3	8	90°	
L-914EDT	GaAsP/GaP	625	orange diffused	1.8	8	100°	
L-914ET	GaAsP/GaP	625	orange transparent	3	8	90°	
L-914ADT	GaAsP/GaP	588	amber diffused	1.8	5	100°	
L-914AT	GaAsP/GaP	588	amber transparent	1.8	7	90°	
L-914GDT	GaP	568	green diffused	1.8	6	100°	
L-914GT	GaP	568	green transparent	3	8	90°	
L-914PGT	GaP	555	green transparent	0.4	1	90°	
L-91A7IDT	GaAsP/GaP	625	red diffused	3	8	60°	2mm x 3mm Rectangular  
L-91A7YDT	GaAsP/GaP	588	yellow diffused	1	3.5	60°	
L-91A7GDT	GaP	568	green diffused	3	7	60°	

NOTES:
 1. All dimensions are in millimeters (inches).
 2. Tolerance is $\pm 0.25\text{mm}$ (0.01") unless otherwise noted.

RECTANGULAR LED

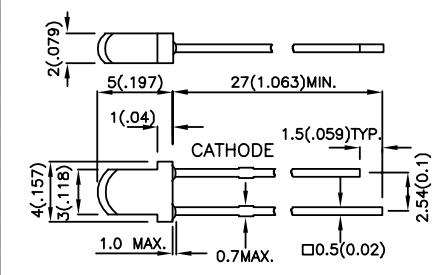
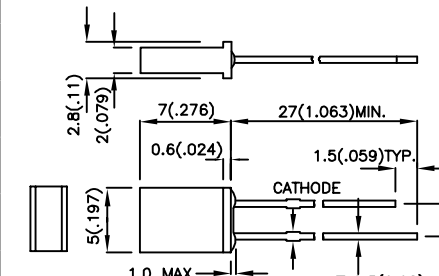
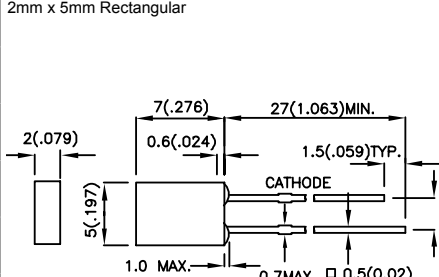
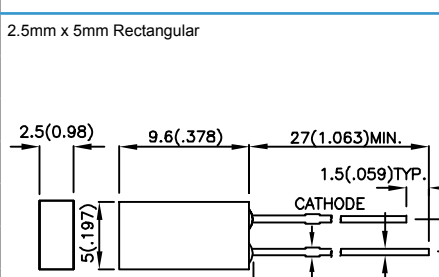
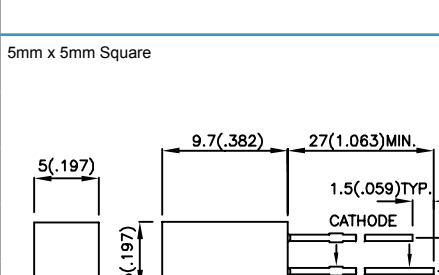
PART NUMBER	MATERIAL	λ_D (nm)	LENS TYPE	Iv (mcd) @10mA *20mA		VIEWING ANGLE	DIMENSION
				MIN.	TYP.		
L-169XHD	GaP	660	red diffused	1	3	60°	2mm x 3mm Rectangular 
L-169XHT	GaP	660	red transparent	1.8	5	50°	
L-169XID	GaAsP/GaP	625	red diffused	8	15	60°	
L-169XIT	GaAsP/GaP	625	red transparent	12	30	50°	
L-169XYD	GaAsP/GaP	588	yellow diffused	5	10	60°	
L-169XYT	GaAsP/GaP	588	yellow transparent	5	15	50°	
L-169XAT	GaAsP/GaP	588	amber transparent	5	15	50°	
L-169XGD	GaP	568	green diffused	5	15	60°	
L-169XGT	GaP	568	green transparent	5	20	50°	
L-169XPGD	GaP	555	green diffused	1.8	5	60°	
L-169XPGTL	GaP	555	green transparent	3	8	50°	
L-103HDT	GaP	660	red diffused	0.4	1	110°	2mm x 5mm Rectangular 
L-103IDT	GaAsP/GaP	625	red diffused	1.8	5	110°	
L-103SRDT	GaAlAs	640	red diffused	*36	*80	110°	
L-103EDT	GaAsP/GaP	625	orange diffused	1.8	5	110°	
L-103YDT	GaAsP/GaP	588	yellow diffused	1	4	110°	
L-103GDT	GaP	568	green diffused	1.8	5	110°	
L-113HDT	GaP	660	red diffused	0.4	1	110°	2mm x 5mm Rectangular 
L-113IDT	GaAsP/GaP	625	red diffused	3	5	110°	
L-113SRDT	GaAlAs	640	red diffused	*36	*80	110°	
L-113EDT	GaAsP/GaP	625	orange diffused	3	5	110°	
L-113YDT	GaAsP/GaP	588	yellow diffused	1	4	110°	
L-113GDT	GaP	568	green diffused	1.8	5	110°	
L-383HDT	GaP	660	red diffused	0.4	1	110°	2.5mm x 5mm Rectangular 
L-383IDT	GaAsP/GaP	625	red diffused	3	5	110°	
L-383SRDT	GaAlAs	640	red diffused	*36	*70	110°	
L-383EDT	GaAsP/GaP	625	orange diffused	3	5	110°	
L-383SRWT	GaAlAs	640	white diffused	*36	*70	110°	
L-383YDT	GaAsP/GaP	588	yellow diffused	1	4	110°	
L-383GDT	GaP	568	green diffused	1	4	110°	
L-383SGWT	GaP	568	white diffused	*7	*15	110°	
L-1553HDT	GaP	660	red diffused	0.4	1	110°	5mm x 5mm Square 
L-1553IDT	GaAsP/GaP	625	red diffused	3	8	110°	
L-1553SRDT	GaAlAs	640	red diffused	*36	*80	110°	
L-1553EDT	GaAsP/GaP	625	orange diffused	3	8	110°	
L-1553YDT	GaAsP/GaP	588	yellow diffused	1	5	110°	
L-1553GDT	GaP	568	green diffused	1	5	110°	

NOTES:

1. All dimensions are in millimeters (inches).
2. Tolerance is $\pm 0.25\text{mm}$ (0.01") unless otherwise noted.

CYLINDRICAL LED

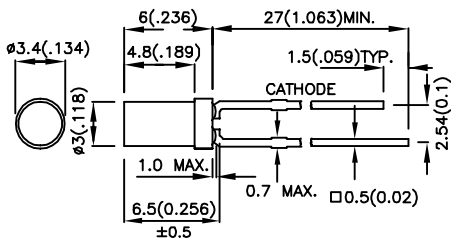
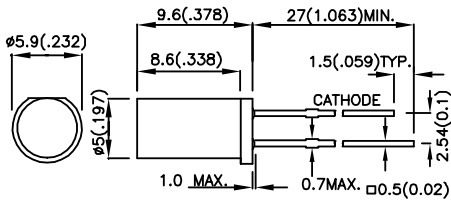
PART NUMBER	MATERIAL	λ_D (nm)	LENS TYPE	Iv (mcd) @10mA *20mA		VIEWING ANGLE 2 θ 1/2	DIMENSION
				MIN.	TYP.		
L-424HDT	GaP	660	red diffused	0.4	1	100°	T-1 (3mm) Cylindrical 
L-424IDT	GaAsP/GaP	625	red diffused	3	5	100°	
L-424SRDT	GaAlAs	640	red diffused	*36	*100	100°	
L-424EDT	GaAsP/GaP	625	orange diffused	3	5	100°	
L-424YDT	GaAsP/GaP	588	yellow diffused	1	4	100°	
L-424GDT	GaP	568	green diffused	1	4	100°	
L-483HDT	GaP	660	red diffused	0.4	1	100°	T-1 3/4 (5mm) Cylindrical 
L-483IDT	GaAsP/GaP	625	red diffused	1.8	5	100°	
L-483EDT	GaAsP/GaP	625	orange diffused	3	7	100°	
L-483YDT	GaAsP/GaP	588	yellow diffused	0.7	3	100°	
L-483GDT	GaP	568	green diffused	1	4	100°	

MULTI-COLOR LED

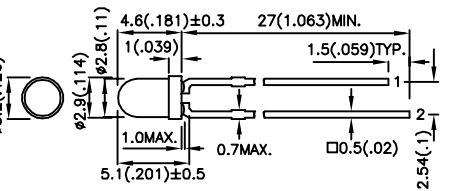
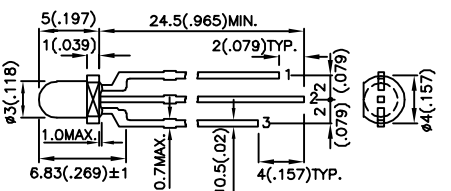
PART NUMBER	MATERIAL	λ_D (nm)	LENS TYPE	Iv (mcd) @20mA		VIEWING ANGLE 2 θ 1/2	DIMENSION
				MIN.	TYP.		
L-937IID	GaAsP/GaP	625	red diffused	7	20	60°	T-1 (3mm) Round 
	GaAsP/GaP	625					
L-937YYD	GaAsP/GaP	588	yellow diffused	4	10	60°	
	GaAsP/GaP	588					
L-937GGD	GaP	568	green diffused	4	15	60°	
	GaP	568					
L-937EGW	GaAsP/GaP	625	white diffused	7	20	60°	
	GaP	568					
L-937EYW	GaAsP/GaP	625	white diffused	7	20	60°	
	GaAsP/GaP	588					
L-937GYW	GaP	568	white diffused	7	16	60°	
	GaAsP/GaP	588					
L-115VEGW	GaAsP/GaP	625	white diffused	10	50	60°	T-1 (3mm) Round 
	GaP	568					
L-115VEYW	GaAsP/GaP	625	white diffused	10	50	60°	
	GaAsP/GaP	588					
L-115VGYW	GaP	568	white diffused	10	30	60°	
	GaAsP/GaP	588					

NOTES:

1. All dimensions are in millimeters (inches).
2. Tolerance is $\pm 0.25\text{mm}$ ($0.01''$) unless otherwise noted.

MULTI-COLOR LED

PART NUMBER	MATERIAL	λ_D (nm)	LENS TYPE	Iv (mcd) @20mA		VIEWING ANGLE	DIMENSION				
				MIN.	TYP.						
L-115WEGW	GaAsP/GaP	625	white diffused	10	40	60°	<p>T-1 (3mm) Round</p> <p>$\phi 3(.118)$</p> <p>1 E G 2 3</p> <p>1 E Y 2 3</p> <p>1 G Y 2 3</p> <p>L-115W</p>				
	GaP	568		10	35						
L-115WEYW	GaAsP/GaP	625	white diffused	10	40	60°		<p>T-1 (3mm) Round</p> <p>$\phi 3(.118)$</p> <p>1 E G 2 3</p> <p>1 E Y 2 3</p> <p>1 G Y 2 3</p> <p>L-3V</p>			
	GaAsP/GaP	588		7	20						
L-115WGYW	GaP	568	white diffused	10	35	60°			<p>T-1 (3mm) Round</p> <p>$\phi 3(.118)$</p> <p>1 E G 2 3</p> <p>1 E Y 2 3</p> <p>1 G Y 2 3</p>		
	GaAsP/GaP	588		7	20						
L-3VEGW	GaAsP/GaP	625	white diffused	10	40	60°				<p>T-1 (3mm) Round</p> <p>$\phi 3(.118)$</p> <p>1 E G 2 3</p> <p>1 E Y 2 3</p> <p>1 G Y 2 3</p>	
	GaP	568		10	35						
L-3VEYW	GaAsP/GaP	625	white diffused	10	40	60°					<p>T-1 (3mm) Round</p> <p>$\phi 3(.118)$</p> <p>1 E G 2 3</p> <p>1 E Y 2 3</p> <p>1 G Y 2 3</p>
	GaAsP/GaP	588		7	15						
L-3VGYW	GaP	568	white diffused	10	35	60°	<p>T-1 (3mm) Round</p> <p>$\phi 3(.118)$</p> <p>1 E G 2 3</p> <p>1 E Y 2 3</p> <p>1 G Y 2 3</p>				
	GaAsP/GaP	588		7	15						
L-7113SRSGW	GaAlAs	640	white diffused	110	200	35°		<p>T-1 3/4 (5mm) Round</p> <p>$\phi 5.9(.232)$</p> <p>1 SR 2 SG</p> <p>L-7113SRSG</p>			
	GaP	568		18	60						
L-57IID	GaAsP/GaP	625	red diffused	7	20	60°			<p>T-1 3/4 (5mm) Round</p> <p>$\phi 5.9(.232)$</p> <p>1 SR 2 SG</p> <p>L-57</p>		
GaAsP/GaP	625	7		20							
L-57YYD	GaAsP/GaP	588	yellow diffused	4	10	60°				<p>T-1 3/4 (5mm) Round</p> <p>$\phi 5.9(.232)$</p> <p>1 SR 2 SG</p> <p>L-57</p>	
	GaAsP/GaP	588		4	10						
L-57GGD	GaP	568	green diffused	4	10	60°					<p>T-1 3/4 (5mm) Round</p> <p>$\phi 5.9(.232)$</p> <p>1 SR 2 SG</p> <p>L-57</p>
	GaP	568		4	10						
L-57SRSRD	GaAlAs	640	red diffused	70	150	60°	<p>T-1 3/4 (5mm) Round</p> <p>$\phi 5.9(.232)$</p> <p>1 SR 2 SG</p> <p>L-57</p>				
	GaAlAs	640		70	150						
L-57EGW	GaAsP/GaP	625	white diffused	10	30	60°		<p>T-1 3/4 (5mm) Round</p> <p>$\phi 5.9(.232)$</p> <p>1 SR 2 SG</p> <p>L-57</p>			
	GaP	568		10	20						
L-57EYW	GaAsP/GaP	625	white diffused	10	30	60°			<p>T-1 3/4 (5mm) Round</p> <p>$\phi 5.9(.232)$</p> <p>1 SR 2 SG</p> <p>L-57</p>		
	GaAsP/GaP	588		4	10						
L-57GYW	GaP	568	white diffused	10	20	60°				<p>T-1 3/4 (5mm) Round</p> <p>$\phi 5.9(.232)$</p> <p>1 SR 2 SG</p> <p>L-57</p>	
	GaAsP/GaP	588		4	10						

NOTES:

- 1. All dimensions are in millimeters(inches).
- 2. Tolerance is $\pm 0.25\text{mm}(0.01")$ unless otherwise noted.

MULTI-COLOR LED

PART NUMBER	MATERIAL	λ_D (nm)	LENS TYPE	Iv (mcd) @20mA		VIEWING ANGLE 2 θ 1/2	DIMENSION	
				MIN.	TYP.			
L-59EGW	GaAsP/GaP	625	white diffused	18	60	60°		
	GaP	568		18	50			
L-59EGW-CA	GaAsP/GaP	625	white diffused	2.6	5	60°		
	GaP	568		1.6	5			
L-59EYW	GaAsP/GaP	625	white diffused	18	60	60°		
	GaAsP/GaP	588		18	40			
L-59GYW	GaP	568	white diffused	18	50	60°		
	GaAsP/GaP	588		18	40			
L-59SRSGW-CC	GaAlAs	640	white diffused	110	220	60°		
	GaP	568		18	50			
L-59SURKMGKW	AlGaInP	630	white diffused	280	700	60°		
	AlGaInP	570		50	170			
L-59EGC	GaAsP/GaP	625	water clear	70	150	24°		
	GaP	568		70	150			
L-59EYC	GaAsP/GaP	625	water clear	70	150	24°		
	GaAsP/GaP	588		18	60			
L-59GYC	GaP	568	water clear	70	150	24°		
	GaAsP/GaP	588		18	60			
L-59SRSGC-CC	GaAlAs	640	water clear	280	600	24°		
	GaP	568		70	200			
L-59SURKSGC	AlGaInP	630	water clear	900	2800	24°		
	GaP	568		70	200			
L-154A4SURKQBDZGC	AlGaInP	630	water clear	380	700	50°		
	InGaN	470		480	1000			
L-154A4SURKQBDZGW	InGaN	525	white diffused	480	1300	60°		
	AlGaInP	630		280	500			
L-154A4SUREQBFZGEC	InGaN	470	water clear	110	350	50°		
	InGaN	525		280	750			
L-154A4SUREQBFZGEC	AlGaInP	630	water clear	650	1200	50°		
	InGaN	465		1200	1700			
L-154A4SUREQBFZGEW	InGaN	525	white diffused	2800	3800	60°		
	AlGaInP	630		380	750			
L-154A4SUREQBFZGEW	InGaN	465	white diffused	280	420	60°		
	InGaN	525		900	1700			
L-799EGW	GaAsP/GaP	625	white diffused	36	80	50°		
	GaP	568		18	50			
L-799SRSGW-CC	GaAlAs	640	white diffused	110	200	50°		
	GaP	568		18	50			
L-799SURKMGKW	AlGaInP	630	white diffused	380	600	50°		
	AlGaInP	570		50	130			
L-819IID	GaAsP/GaP	625	red diffused	36	80	50°		
	GaAsP/GaP	625		36	80			
L-819YYD	GaAsP/GaP	588	yellow diffused	10	30	50°		
	GaAsP/GaP	588		10	30			
L-819GGD	GaP	568	green diffused	10	40	50°		
	GaP	568		10	40			
L-819EGW	GaAsP/GaP	625	white diffused	36	80	50°		
	GaP	568		18	50			
L-819SRSGW-CC	GaAlAs	640	white diffused	110	300	50°		
	GaP	568		36	50			
L-819SURKMGKW	AlGaInP	630	white diffused	380	750	50°		
	AlGaInP	570		50	130			

NOTES:
 1. All dimensions are in millimeters (inches).
 2. Tolerance is $\pm 0.25\text{mm}$ ($0.01''$) unless otherwise noted.

MULTI-COLOR LED

PART NUMBER	MATERIAL	λ_D (nm)	LENS TYPE	Iv (mcd) @20mA		VIEWING ANGLE	DIMENSION
				MIN.	TYP.		
L-283A9NGWT/TG	GaAsP/GaP	610	white diffused	2.6	15	120°	1.75mm x 3.5mm Rectangular
	GaP	568		4	10		
L-91A6GNWT	GaP	568	white diffused	1.6	4	110°	2mm x 3mm Rectangular
	GaAsP/GaP	610		4	10		
L-91A6YGWT	GaAsP/GaP	588	white diffused	1.6	4	110°	2mm x 3mm Rectangular
	GaP	568		1.6	4		
L-113SRSGWT	GaAlAs	640	white diffused	36	70	110°	2mm x 5mm Rectangular
	GaP	568		7	10		
L-117EGWT	GaAsP/GaP	625	white diffused	4	10	110°	2mm x 5mm Rectangular
	GaP	568		4	8		
L-117EYWT	GaAsP/GaP	625	white diffused	4	10	110°	2mm x 5mm Rectangular
	GaAsP/GaP	588		2.6	6		
L-117GYWT	GaP	568	white diffused	4	8	110°	2mm x 5mm Rectangular
	GaAsP/GaP	588		2.6	6		

NOTES:
 1. All dimensions are in millimeters(inches).
 2. Tolerance is $\pm 0.25\text{mm}(0.01\text{'})$ unless otherwise noted.

MULTI-COLOR LED

PART NUMBER	MATERIAL	λ_D (nm)	LENS TYPE	Iv (mcd) @20mA		VIEWING ANGLE 2 θ 1/2	DIMENSION	
				MIN.	TYP.			
L-119EGWT	GaAsP/GaP	625	white diffused	7	20	110°	2mm x 5mm Rectangular 	
	GaP	568		4	12			
L-119SRSGWT-CC	GaAlAs	640	white diffused	18	60	110°		
	GaP	568		4	12			
L-119SURKMGKWT	AlGaInP	630	white diffused	70	170	110°		
	AlGaInP	570		10	30			
L-483SRSGWT	GaAlAs	640	white diffused	18	50	80°		T-1 3/4 (5mm) Cylindrical
	GaP	568		4	10			

LOW CURRENT LED

PART NUMBER	MATERIAL	λ_D (nm)	LENS TYPE	Iv (mcd) @2mA		VIEWING ANGLE 2 θ 1/2	DIMENSION
				MIN.	TYP.		
L-7104LID	GaAsP/GaP	625	red diffused	0.7	3	40°	T-1 (3mm) Round
L-7104LSRD	GaAlAs	640	red diffused	8	20	40°	
L-7104LYD	GaAsP/GaP	588	yellow diffused	0.7	1.5	40°	
L-7104LGD	GaP	568	green diffused	0.7	2	40°	
L-7113LID	GaAsP/GaP	625	red diffused	0.7	5	30°	T-1 3/4 (5mm) Round
L-7113LSRD	GaAlAs	640	red diffused	8	20	30°	
L-7113LYD	GaAsP/GaP	588	yellow diffused	0.7	2	30°	
L-7113LGD	GaP	568	green diffused	0.7	2	30°	

NOTES:
 1. All dimensions are in millimeters (inches).
 2. Tolerance is ±0.25mm (0.01") unless otherwise noted.

BLINKING LED

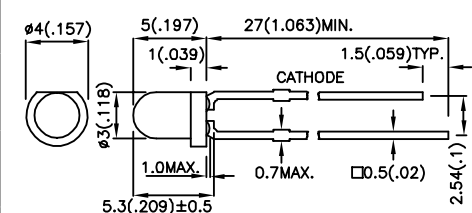
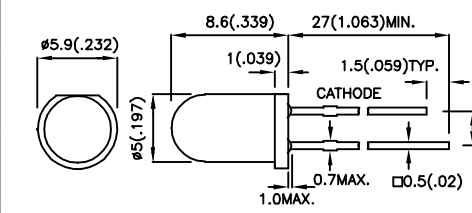
PART NUMBER	MATERIAL	λ_D (nm)	LENS TYPE	Iv (mcd) V=9V		VIEWING ANGLE 2 θ 1/2	DIMENSION
				MIN.	TYP.		
L-36BHD	GaP	660	red diffused	1	2	60°	T-1 (3mm) Round 
L-36BID	GaAsP/GaP	625	red diffused	12	20	60°	
L-36BSRD-B	GaAlAs	640	red diffused	110	200	60°	
L-36BYD	GaAsP/GaP	588	yellow diffused	5	10	60°	
L-36BGD	GaP	568	green diffused	5	15	60°	
L-56BHD	GaP	660	red diffused	0.7	4	60°	T-1 3/4 (5mm) Round 
L-56BID	GaAsP/GaP	625	red diffused	18	40	60°	
L-56BSRD-B	GaAlAs	640	red diffused	110	200	60°	
L-56BYD	GaAsP/GaP	588	yellow diffused	5	20	60°	
L-56BGD	GaP	568	green diffused	5	20	60°	

RESISTOR LED

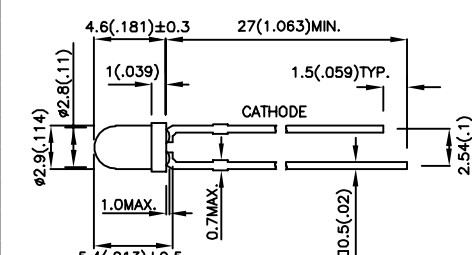
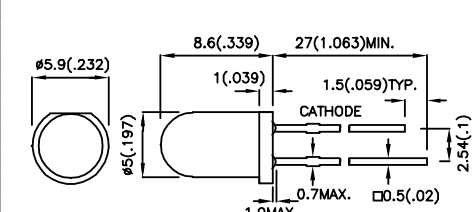
PART NUMBER	MATERIAL	λ_D (nm)	LENS TYPE	Iv (mcd) V=5V *V=12V **V=14V		VIEWING ANGLE 2 θ 1/2	DIMENSION
				MIN.	TYP.		
L-7104ID-5V	GaAsP/GaP	625	red diffused	8	20	40°	T-1 (3mm) Round 
L-7104ID-12V	GaAsP/GaP	625	red diffused	*8	*20	40°	
L-7104ID-14V	GaAsP/GaP	625	red diffused	**8	**20	40°	
L-7104SRD-5V	GaAlAs	640	red diffused	70	150	40°	
L-7104SRD-12V	GaAlAs	640	red diffused	*40	*100	40°	
L-7104SRD-14V	GaAlAs	640	red diffused	**28	**90	40°	
L-7104YD-5V	GaAsP/GaP	588	yellow diffused	8	15	40°	
L-7104YD-12V	GaAsP/GaP	588	yellow diffused	*3	*11	40°	
L-7104YD-14V	GaAsP/GaP	588	yellow diffused	**3	**11	40°	
L-7104GD-5V	GaP	568	green diffused	8	20	40°	
L-7104GD-12V	GaP	568	green diffused	*8	*20	40°	
L-7104GD-14V	GaP	568	green diffused	**8	**20	40°	
L-7113ID-5V	GaAsP/GaP	625	red diffused	12	30	30°	T-1 3/4 (5mm) Round 
L-7113ID-12V	GaAsP/GaP	625	red diffused	*12	*30	30°	
L-7113ID-14V	GaAsP/GaP	625	red diffused	**12	**30	30°	
L-7113SRD-5V	GaAlAs	640	red diffused	110	180	30°	
L-7113SRD-12V	GaAlAs	640	red diffused	*110	*180	30°	
L-7113SRD-14V	GaAlAs	640	red diffused	**70	**160	30°	
L-7113YD-5V	GaAsP/GaP	588	yellow diffused	5	20	30°	
L-7113YD-12V	GaAsP/GaP	588	yellow diffused	*5	*20	30°	
L-7113YD-14V	GaAsP/GaP	588	yellow diffused	**5	**16	30°	
L-7113GD-5V	GaP	568	green diffused	8	20	30°	
L-7113GD-12V	GaP	568	green diffused	*8	*20	30°	
L-7113GD-14V	GaP	568	green diffused	**5	**18	30°	
L-7113SGD-5V	GaP	568	green diffused	8	20	30°	
L-7113SGD-12V	GaP	568	green diffused	*8	*20	30°	
L-7113SGD-14V	GaP	568	green diffused	**5	**18	30°	

NOTES:

1. All dimensions are in millimeters (inches).
2. Tolerance is $\pm 0.25\text{mm}$ (0.01") unless otherwise noted.

SUPER FLUX LED

PART NUMBER	MATERIAL	λD (nm)	LENS TYPE	Iv (mcd) @20mA		VIEWING ANGLE 2θ1/2	DIMENSION
				MIN.	TYP.		
L-7676CSURC-G	AlGaInP	630	water clear	380	750	70°	7.6mm x 7.6mm
L-7676CSEC-H	AlGaInP	630	water clear	480	1300	70°	
L-7676CSYC-H	AlGaInP	589	water clear	280	450	70°	
L-7676CZGC-E	InGaN	525	water clear	900	2000	70°	
L-7676CZGC-G	InGaN	525	water clear	1200	2200	70°	
L-7676CQBC-G	InGaN	465	water clear	380	780	70°	
L-76765CSURC-G	AlGaInP	630	water clear	180	650	70°	7.6mm x 7.6mm
L-76765CSEC-H	AlGaInP	630	water clear	650	1800	70°	
L-76765CSYC-H	AlGaInP	589	water clear	110	400	70°	
L-76765CZGC-E	InGaN	525	water clear	650	1600	70°	
L-76765CZGC-G	InGaN	525	water clear	900	1800	70°	
L-76765CQBC-G	InGaN	465	water clear	280	620	70°	

PART NUMBER	MATERIAL	λD (nm)	LENS TYPE	Iv (mcd) @70mA *30mA		VIEWING ANGLE 2θ1/2	DIMENSION
				MIN.	TYP.		
L-7679C1SURC-G	AlGaInP	630	water clear	1800	3000	70°	7.62mm x 7.62mm
L-7679C1SEC-H	AlGaInP	630	water clear	6500	8000	70°	
L-7679C1SYC-H	AlGaInP	589	water clear	1200	4000	70°	
L-7679C1ZGC	InGaN	525	water clear	*1200	*2500	70°	
L-7679C1QBC-D	InGaN	470	water clear	*380	*700	70°	

NOTES:
 1. All dimensions are in millimeters(inches).
 2. Tolerance is ±0.25mm(0.01") unless otherwise noted.

SIDE VIEW

PART NUMBER	MATERIAL	λ_D (nm)	LENS TYPE	Iv (mcd) @20mA		VIEWING ANGLE	DIMENSION
				MIN.	TYP.		
KA-9219/2EC	GaAsP/GaP	625	water clear	18	50	100°	<p>9.2mm x 1.9mm</p>
KA-9219/2SRC	GaAlAs	640	water clear	70	200	100°	
KA-9219/2YC	GaAsP/GaP	588	water clear	10	20	100°	
KA-9219/2SGC	GaP	568	water clear	7	40	100°	
KA-1114/2EC-CC-L5	GaAsP/GaP	625	water clear	4	9	120°	<p>11mm x 1.4mm</p>
KA-1114/2YC-CC-L5	GaAsP/GaP	588	water clear	4	10	120°	
KA-1114/2SYC-CC-L5	AlGaInP	590	water clear	50	100	120°	
KA-1114/2SGC-CC-L5	GaP	568	water clear	7	16	120°	
KA-1114/2QBC-D-CC-L5	InGaN	470	water clear	70	130	120°	

NOTES:

1. All dimensions are in millimeters (inches).
2. Tolerance is $\pm 0.25\text{mm}$ ($0.01''$) unless otherwise noted.

TAPE AND REEL SELECTIONS

L-7104-TNR2.54

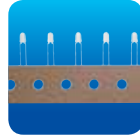

L-7104-TNR2.54

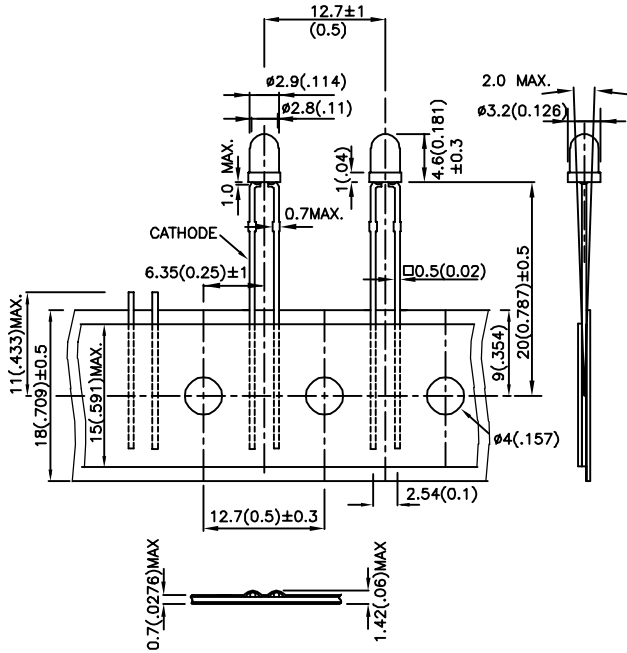

L-7113-TNR2.54

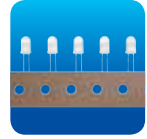

L-7113-TNR2.54

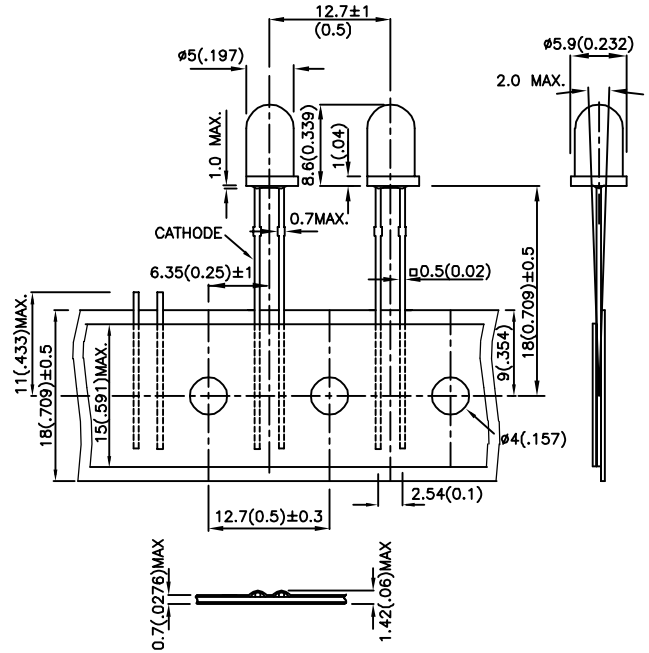

L-59-TNR2.54

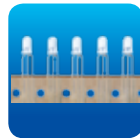

L-59-TNR2.54

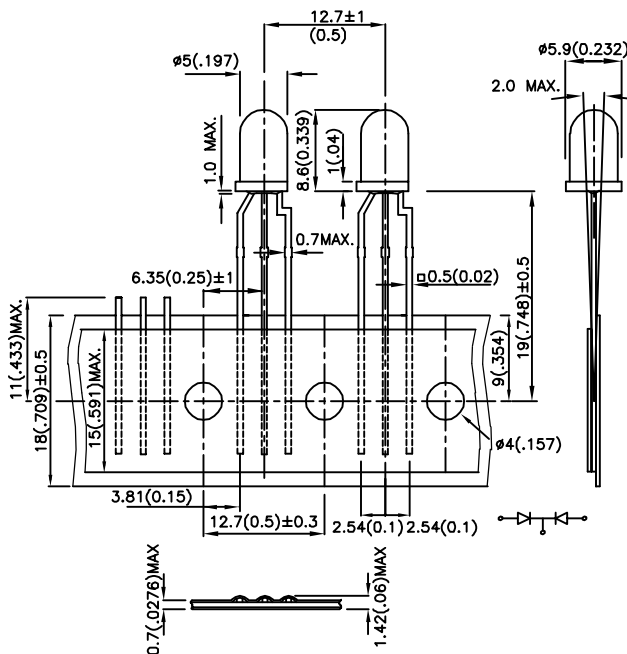

REEL DIMENSION

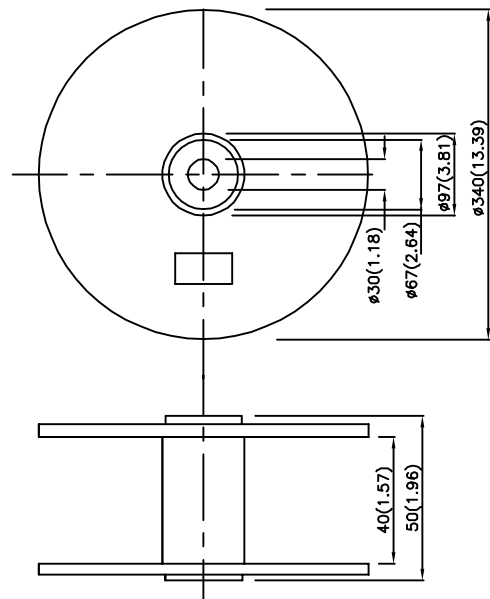

NOTES:

1. All dimensions are in millimeters(inches).
2. Tolerance is ±0.25mm(0.01") unless otherwise noted.

Kingbright

Optoelectronic Components



SMD Display

44

7-Segment SMD Display

44

Alphanumeric SMD Display





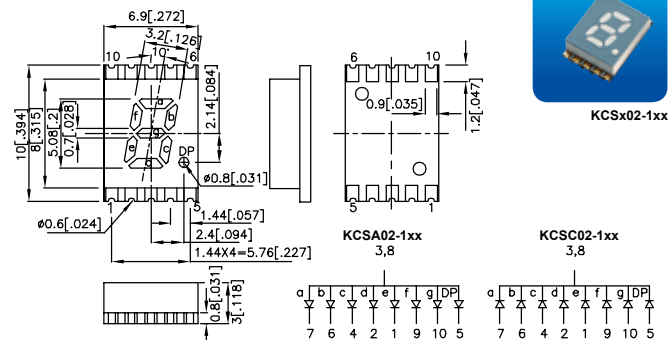
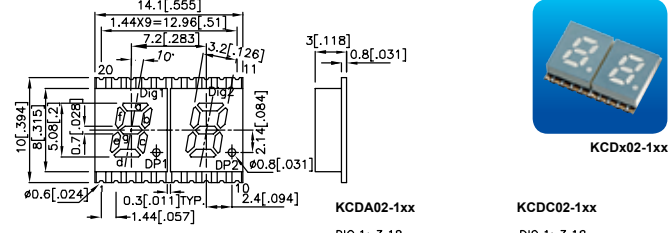
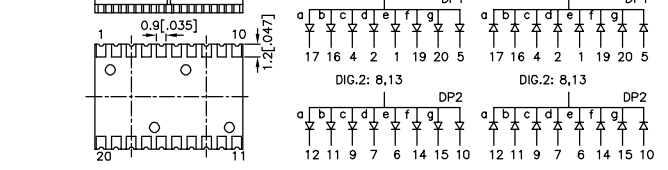
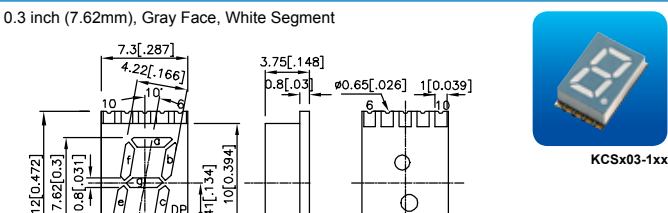
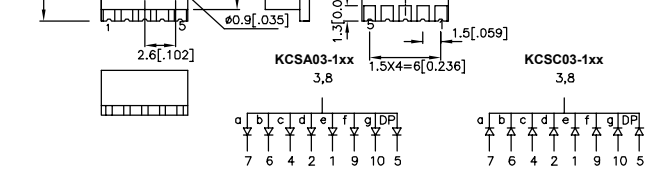
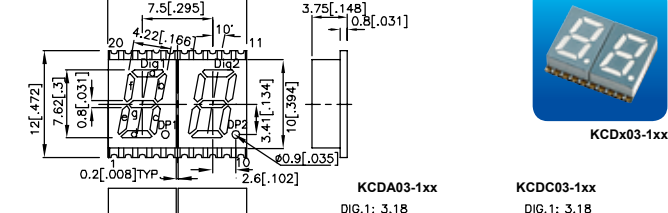
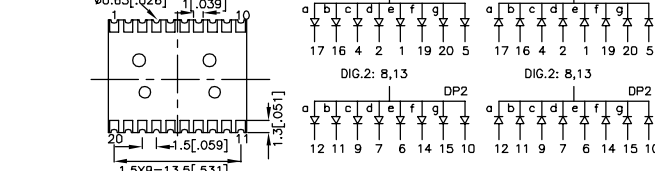
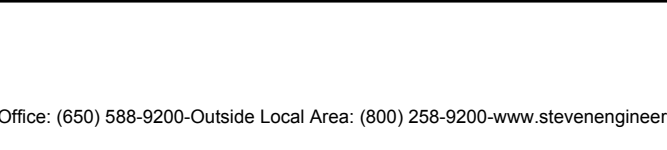

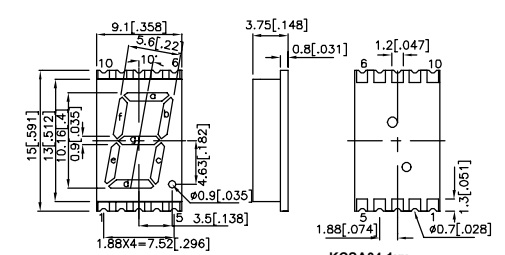

46

7-SEGMENT SMD DISPLAY

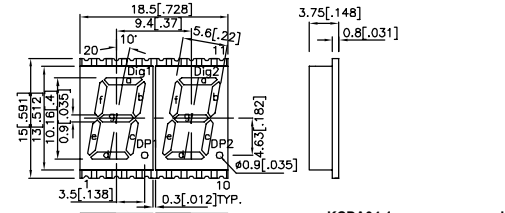
PART NUMBER		MATERIAL	λ D (nm)	Iv (ucd) @10mA		DIMENSION
COMMON ANODE	COMMON CATHODE			MIN.	TYP.	
KCSA02-105 KCDA02-105	KCSC02-105 KCDC02-105	AlGaInP	630	8000	30400	0.2 inch (5.08mm), Gray Face, White Segment 
KCSA02-106 KCDA02-106	KCSC02-106 KCDC02-106	AlGaInP	601	12000	37200	
KCSA02-107 KCDA02-107	KCSC02-107 KCDC02-107	AlGaInP	590	12000	34000	
KCSA02-123 KCDA02-123	KCSC02-123 KCDC02-123	AlGaInP	570	4700	26000	
KCSA03-105 KCDA03-105	KCSC03-105 KCDC03-105	AlGaInP	630	8000	27000	0.3 inch (7.62mm), Gray Face, White Segment 
KCSA03-106 KCDA03-106	KCSC03-106 KCDC03-106	AlGaInP	601	18000	46000	
KCSA03-107 KCDA03-107	KCSC03-107 KCDC03-107	AlGaInP	590	18000	36000	
KCSA03-123 KCDA03-123	KCSC03-123 KCDC03-123	AlGaInP	570	4700	16000	

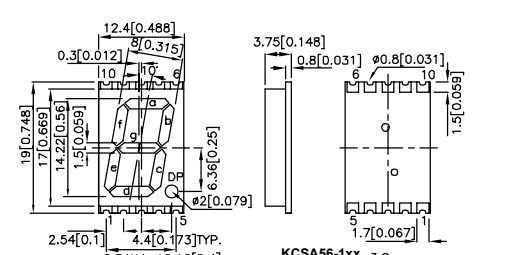
NOTES:
 1. All dimensions are in millimeters(inches).
 2. Tolerance is ±0.25mm(0.01") unless otherwise noted.

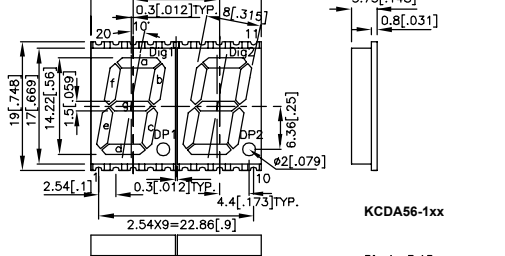
7-SEGMENT SMD DISPLAY

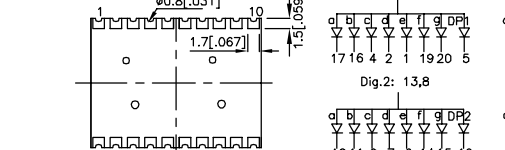
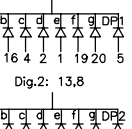
PART NUMBER		MATERIAL	λ D (nm)	Iv (ucd) @10mA		DIMENSION
COMMON ANODE	COMMON CATHODE			MIN.	TYP.	
KCSA04-105 KCDA04-105	KCSC04-105 KCDC04-105	AlGaInP	630	8000	27000	0.4 inch (10.16mm) Gray Face, White Segment   <p>KCSx04-1xx</p>
KCSA04-106 KCDA04-106	KCSC04-106 KCDC04-106	AlGaInP	601	18000	60000	
KCSA04-107 KCDA04-107	KCSC04-107 KCDC04-107	AlGaInP	590	12000	35400	  <p>KCDx04-1xx</p>
KCSA04-123 KCDA04-123	KCSC04-123 KCDC04-123	AlGaInP	570	4700	11000	
KCSA56-105 KCDA56-105	KCSC56-105 KCDC56-105	AlGaInP	630	18000	44000	0.56 inch (14.22mm), Gray Face, White Segment   <p>KCSx56-1xx</p>
KCSA56-106 KCDA56-106	KCSC56-106 KCDC56-106	AlGaInP	601	18000	78000	
KCSA56-107 KCDA56-107	KCSC56-107 KCDC56-107	AlGaInP	590	18000	76000	  <p>KCDx56-1xx</p>
KCSA56-123 KCDA56-123	KCSC56-123 KCDC56-123	AlGaInP	570	8000	35500	
KCSA56-131 KCDA56-131	KCSC56-131 KCDC56-131	InGaN	470	4700	14800	  <p>KCDx56-1xx</p>

NOTES:
 1. All dimensions are in millimeters(inches).
 2. Tolerance is ±0.25mm(0.01") unless otherwise noted.

ALPHANUMERIC SMD DISPLAY

PART NUMBER		MATERIAL	λ D (nm)	Iv (ucd) @10mA		DIMENSION
COMMON ANODE	COMMON CATHODE			MIN.	TYP.	
KCPSA04-105 KCPDA04-105	KCPSC04-105 KCPDC04-105	AlGaInP	630	8000	36000	<p>0.4 inch (10.16mm), Gray Face, White Segment</p> <p>KCPSA04-1xx KCPSC04-1xx</p>
KCPSA04-106 KCPDA04-106	KCPSC04-106 KCPDC04-106	AlGaInP	601	12000	44000	<p>KCPSA04-1xx KCPSC04-1xx</p>
KCPSA04-107 KCPDA04-107	KCPSC04-107 KCPDC04-107	AlGaInP	590	12000	45500	<p>KCPSA04-1xx KCPSC04-1xx</p>
KCPSA04-123 KCPDA04-123	KCPSC04-123 KCPDC04-123	AlGaInP	570	4700	18500	<p>KCPDA04-1xx KCPDC04-1xx</p>

NOTES:
 1. All dimensions are in millimeters(inches).
 2. Tolerance is ±0.25mm(0.01") unless otherwise noted.

Kingbright





Optoelectronic Components

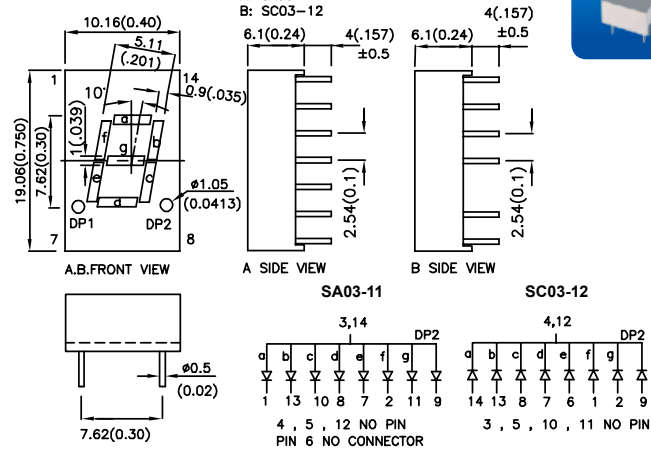

Through-Hole Display **47**

Single Digit 7-Segment Through-Hole Display	47
Dual Digit 7-Segment Through-Hole Display	53
Three Digit 7-Segment Through-Hole Display	55
Four Digit 7-Segment Through-Hole Display	57
Alphanumeric Through-Hole Display	60
Dot Matrix	63

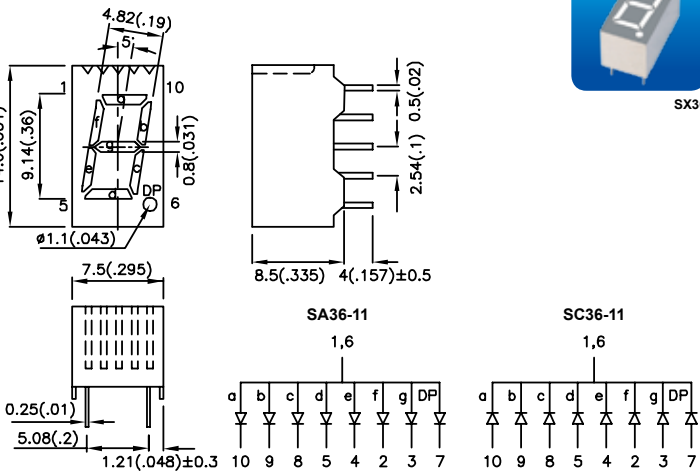

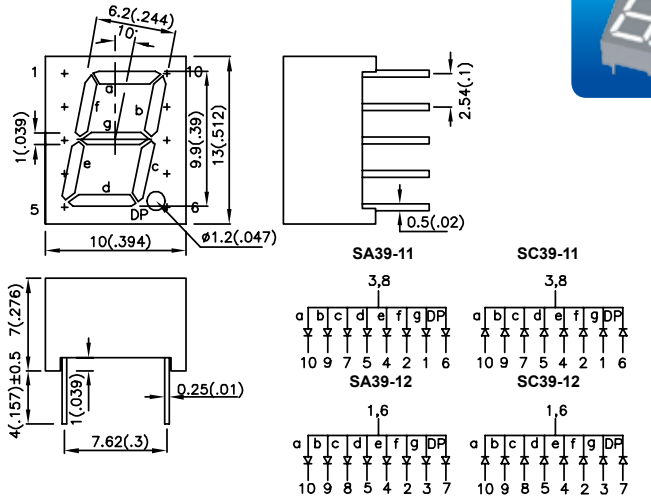



SINGLE DIGIT 7-SEGMENT THROUGH-HOLE DISPLAY

PART NUMBER		MATERIAL	λ D (nm)	Iv (ucd) @10mA		DIMENSION
COMMON ANODE	COMMON CATHODE			MIN.	TYP.	
SA03-11SEKWA	SC03-12SEKWA	AlGaInP	● 601	44000	154400	<p>0.3 inch (7.62mm), Gray Face, White Segment</p>  <p style="text-align: right;">SX30</p> 
SA03-11SURKWA	SC03-12SURKWA	AlGaInP	● 630	12000	47000	
SA03-11SYKWA	SC03-12SYKWA	AlGaInP	● 590	44000	103500	
SA03-11CGKWA	SC03-12CGKWA	AlGaInP	● 570	12000	46000	
SA36-11SEKWA	SC36-11SEKWA	AlGaInP	● 601	18000	37000	<p>0.36 inch (9.14mm), Gray Face, White Segment</p>  <p style="text-align: right;">SX36</p> 
SA36-11SURKWA	SC36-11SURKWA	AlGaInP	● 630	12000	23000	
SA36-11SYKWA	SC36-11SYKWA	AlGaInP	● 590	18000	34800	
SA36-11CGKWA	SC36-11CGKWA	AlGaInP	● 570	8000	13800	
SA39-11SEKWA SA39-12SEKWA	SC39-11SEKWA SC39-12SEKWA	AlGaInP	● 601	18000	58500	<p>0.39 inch (9.9mm), Gray Face, White Segment</p>  <p style="text-align: right;">SX39</p> 
SA39-11SURKWA SA39-12SURKWA	SC39-11SURKWA SC39-12SURKWA	AlGaInP	● 630	12000	26000	
SA39-11SYKWA SA39-12SYKWA	SC39-11SYKWA SC39-12SYKWA	AlGaInP	● 590	12000	34000	
SA39-11CGKWA SA39-12CGKWA	SC39-11CGKWA SC39-12CGKWA	AlGaInP	● 570	8000	20800	

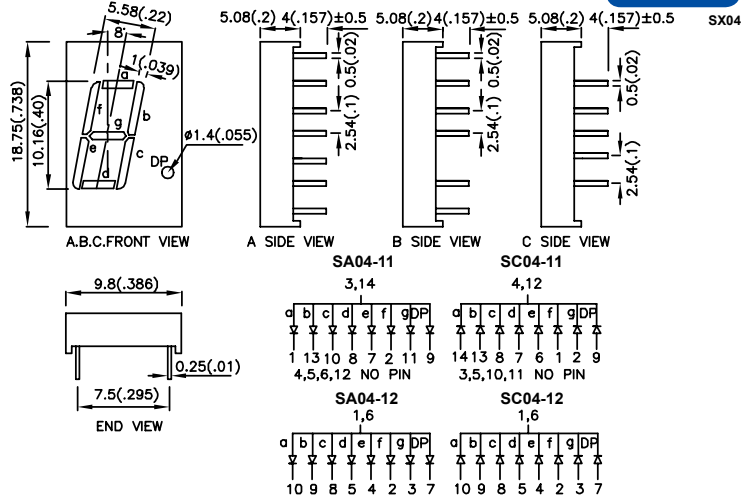
NOTES:

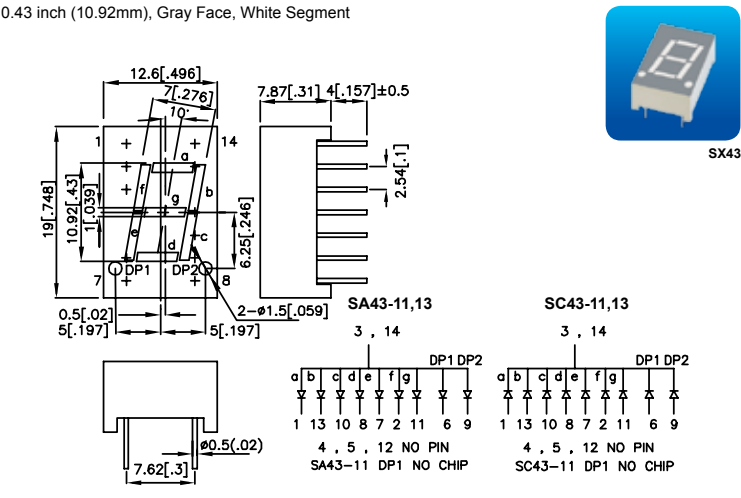
1. All dimensions are in millimeters (inches).
2. Tolerance is ±0.25mm (0.01") unless otherwise noted.

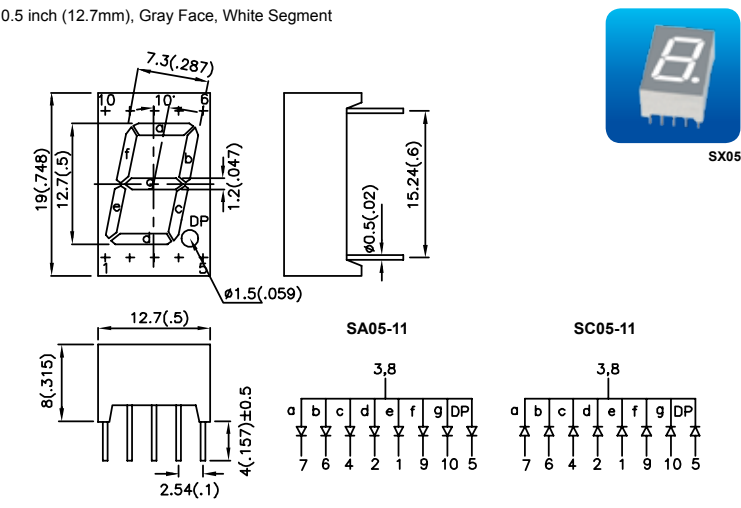
SINGLE DIGIT 7-SEGMENT THROUGH-HOLE DISPLAY

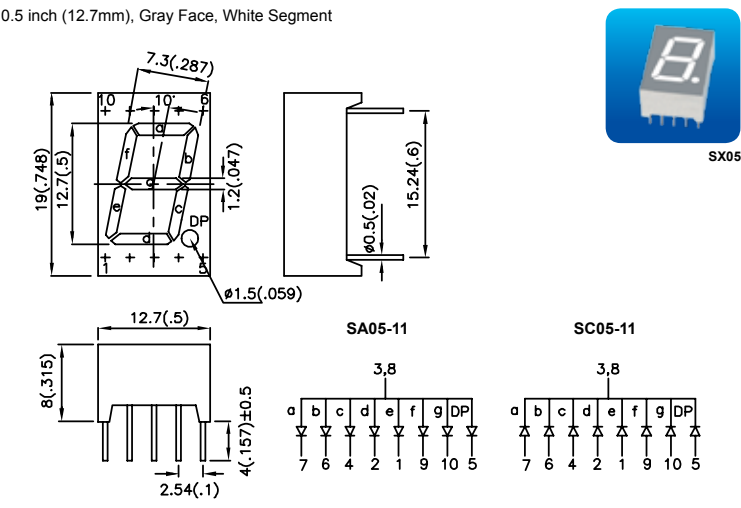
PART NUMBER		MATERIAL	λ D (nm)	Iv (ucd) @10mA		DIMENSION
COMMON ANODE	COMMON CATHODE			MIN.	TYP.	
SA04-11SEKWA SA04-12SEKWA	SC04-11SEKWA SC04-12SEKWA	AlGaInP	601	44000	160700	0.4 inch (10.16mm), Gray Face, White Segment A: SA04-11 B: SC04-11 C: SA/SC04-12  
SA04-11SURKWA SA04-12SURKWA	SC04-11SURKWA SC04-12SURKWA	AlGaInP	630	12000	31600	0.43 inch (10.92mm), Gray Face, White Segment  
SA04-11SYKWA SA04-12SYKWA	SC04-11SYKWA SC04-12SYKWA	AlGaInP	590	44000	92400	
SA04-11CGKWA SA04-12CGKWA	SC04-11CGKWA SC04-12CGKWA	AlGaInP	570	8000	25000	
SA43-11SEKWA SA43-13SEKWA	SC43-11SEKWA SC43-13SEKWA	AlGaInP	601	44000	153500	0.5 inch (12.7mm), Gray Face, White Segment  
SA43-11SURKWA SA43-13SURKWA	SC43-11SURKWA SC43-13SURKWA	AlGaInP	630	12000	55700	
SA43-11SYKWA SA43-13SYKWA	SC43-11SYKWA SC43-13SYKWA	AlGaInP	590	18000	95300	
SA43-11CGKWA SA43-13CGKWA	SC43-11CGKWA SC43-13CGKWA	AlGaInP	570	12000	38700	
SA05-11SEKWA	SC05-11SEKWA	AlGaInP	601	18000	64900	0.5 inch (12.7mm), Gray Face, White Segment  
SA05-11SURKWA	SC05-11SURKWA	AlGaInP	630	18000	30000	
SA05-11SYKWA	SC05-11SYKWA	AlGaInP	590	44000	116400	
SA05-11CGKWA	SC05-11CGKWA	AlGaInP	570	12000	34100	

NOTES:
 1. All dimensions are in millimeters(inches).
 2. Tolerance is ±0.25mm(0.01") unless otherwise noted.

SINGLE DIGIT 7-SEGMENT THROUGH-HOLE DISPLAY

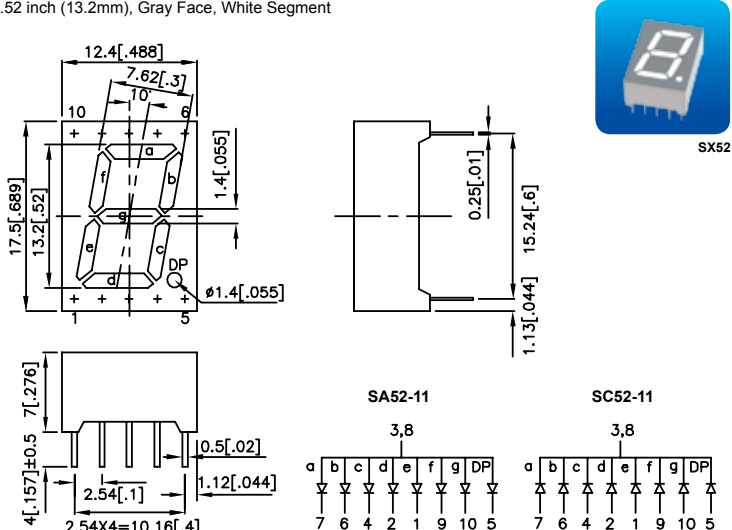
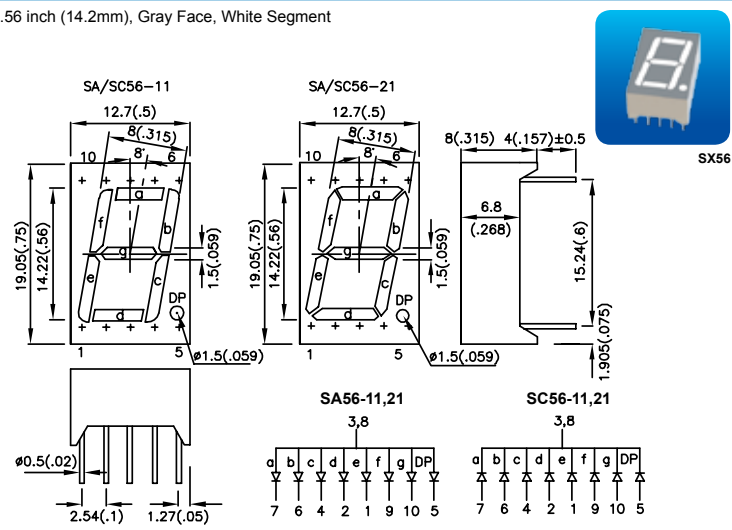
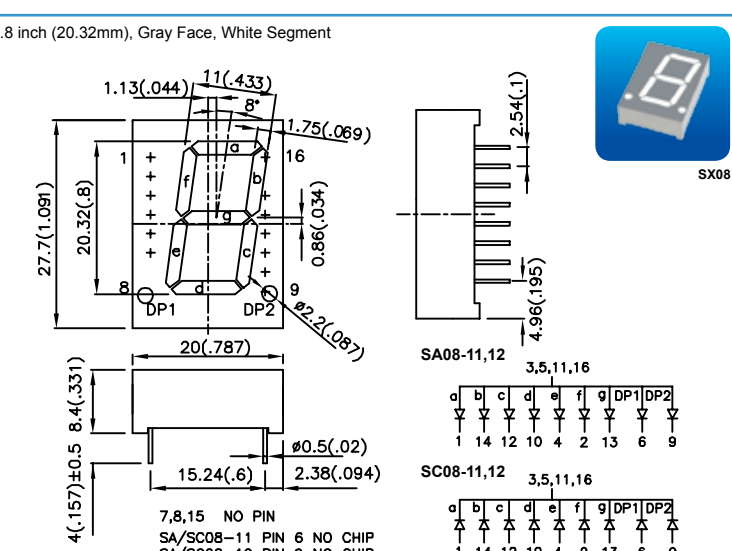
PART NUMBER		MATERIAL	λ D (nm)	Iv (ucd) @10mA		DIMENSION
COMMON ANODE	COMMON CATHODE			MIN.	TYP.	
SA52-11SEKWA	SC52-11SEKWA	AlGaInP	601	26000	159700	<p>0.52 inch (13.2mm), Gray Face, White Segment</p>  <p>SA52-11 and SC52-11 pinout diagrams showing segments a-g and DP, and pin numbers 1-10.</p>
SA52-11SURKWA	SC52-11SURKWA	AlGaInP	630	18000	35000	
SA52-11SYKWA	SC52-11SYKWA	AlGaInP	590	18000	65600	
SA52-11CGKWA	SC52-11CGKWA	AlGaInP	570	12000	45700	
SA56-11SEKWA SA56-21SEKWA	SC56-11SEKWA SC56-21SEKWA	AlGaInP	601	26000	114800	<p>0.56 inch (14.2mm), Gray Face, White Segment</p>  <p>SA56-11 and SC56-11 pinout diagrams showing segments a-g and DP, and pin numbers 1-10.</p>
SA56-11SURKWA SA56-21SURKWA	SC56-11SURKWA SC56-21SURKWA	AlGaInP	630	12000	39100	
SA56-11SYKWA SA56-21SYKWA	SC56-11SYKWA SC56-21SYKWA	AlGaInP	590	18000	54000	
SA56-11CGKWA SA56-21CGKWA	SC56-11CGKWA SC56-21CGKWA	AlGaInP	570	12000	35000	
SA08-11SEKWA SA08-12SEKWA	SC08-11SEKWA SC08-12SEKWA	AlGaInP	601	18000	80000	<p>0.8 inch (20.32mm), Gray Face, White Segment</p>  <p>SA08-11 and SC08-11 pinout diagrams showing segments a-g and DP1, DP2, and pin numbers 1-14.</p>
SA08-11SURKWA SA08-12SURKWA	SC08-11SURKWA SC08-12SURKWA	AlGaInP	630	18000	60600	
SA08-11SYKWA SA08-12SYKWA	SC08-11SYKWA SC08-12SYKWA	AlGaInP	590	26000	66500	
SA08-11CGKWA SA08-12CGKWA	SC08-11CGKWA SC08-12CGKWA	AlGaInP	570	12000	34400	

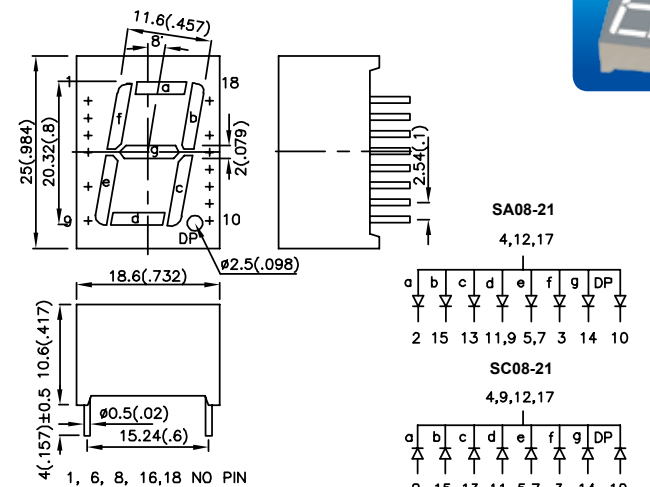
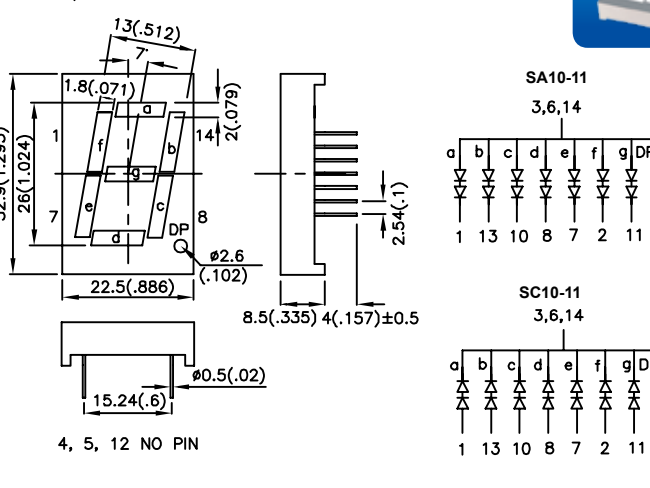

NOTES:
 1. All dimensions are in millimeters (inches).
 2. Tolerance is $\pm 0.25\text{mm}$ (0.01") unless otherwise noted.

SINGLE DIGIT 7-SEGMENT THROUGH-HOLE DISPLAY

PART NUMBER		MATERIAL	λ D (nm)	Iv (ucd) @10mA		DIMENSION
COMMON ANODE	COMMON CATHODE			MIN.	TYP.	
SA08-21SEKWA	SC08-21SEKWA	AlGaInP	601	18000	75900	<p>0.8 inch (20.32mm), Gray Face, White Segment</p>  <p>SA08-21 4,12,17</p> <p>SC08-21 4,9,12,17</p>
SA08-21SURKWA	SC08-21SURKWA	AlGaInP	630	12000	31000	
SA08-21SYKWA	SC08-21SYKWA	AlGaInP	590	26000	49500	
SA08-21CGKWA	SC08-21CGKWA	AlGaInP	570	12000	34400	
SA10-11SEKWA SA10-21SEKWA	SC10-11SEKWA SC10-21SEKWA	AlGaInP	601	128000	443300	<p>1.0 inch (25.4mm), Gray Face, White Segment</p>  <p>SA10-11 3,6,14</p> <p>SC10-11 3,6,14</p>
SA10-11SURKWA SA10-21SURKWA	SC10-11SURKWA SC10-21SURKWA	AlGaInP	630	26000	102900	
SA10-11SYKWA SA10-21SYKWA	SC10-11SYKWA SC10-21SYKWA	AlGaInP	590	128000	403000	
SA10-11CGKWA SA10-21CGKWA	SC10-11CGKWA SC10-21CGKWA	AlGaInP	570	12000	62400	

NOTES:
 1. All dimensions are in millimeters(inches).
 2. Tolerance is ±0.25mm(0.01") unless otherwise noted.

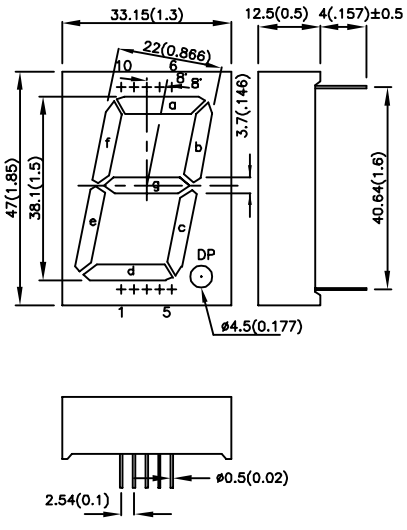
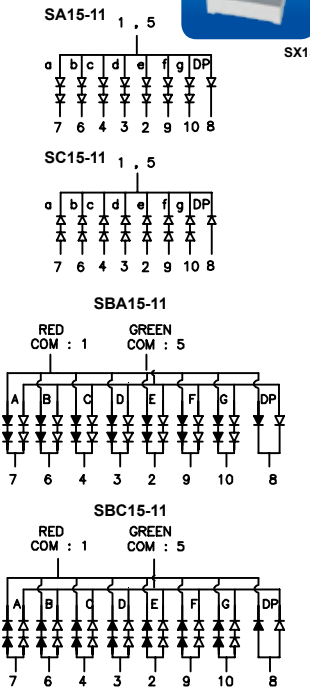
SINGLE DIGIT 7-SEGMENT THROUGH-HOLE DISPLAY

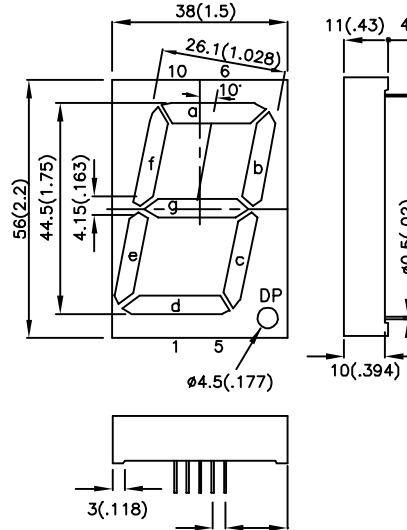
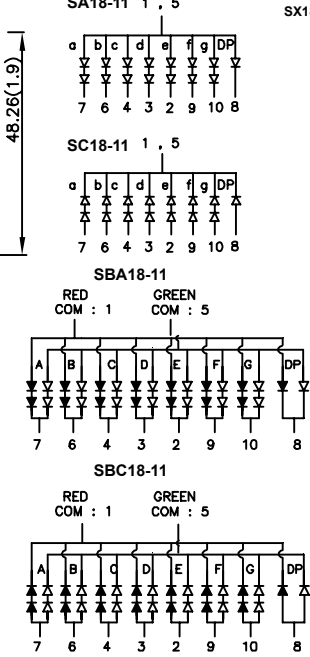
PART NUMBER		MATERIAL	λ D (nm)	Iv (ucd) @10mA		DIMENSION
COMMON ANODE	COMMON CATHODE			MIN.	TYP.	
1.5 inch (38.1mm), Gray Face, White Segment						
SA15-11SEKWA	SC15-11SEKWA	AlGaInP	● 601	128000	419300	  
SA15-11SURKWA	SC15-11SURKWA	AlGaInP	● 630	44000	205500	
SA15-11SYKWA	SC15-11SYKWA	AlGaInP	● 590	128000	405000	
SA15-11CGKWA	SC15-11CGKWA	AlGaInP	● 570	26000	100200	
SA15-11SURKCGKWA	SBC15-11SURKCGKWA	AlGaInP	● 630	12000	43000	
SBA15-11SURKCGKWA	SBC15-11SURKCGKWA	AlGaInP	● 570	26000	100200	
1.75 inch (44.5mm), Gray Face, White Segment						
SA18-11SEKWA	SC18-11SEKWA	AlGaInP	● 601	75000	400000	  
SA18-11SURKWA	SC18-11SURKWA	AlGaInP	● 630	44000	277000	
SA18-11SYKWA	SC18-11SYKWA	AlGaInP	● 590	75000	387000	
SA18-11CGKWA	SC18-11CGKWA	AlGaInP	● 570	44000	186900	
SA18-11SURKCGKWA	SBC18-11SURKCGKWA	AlGaInP	● 630	44000	277000	
SBA18-11SURKCGKWA	SBC18-11SURKCGKWA	AlGaInP	● 570	44000	190000	

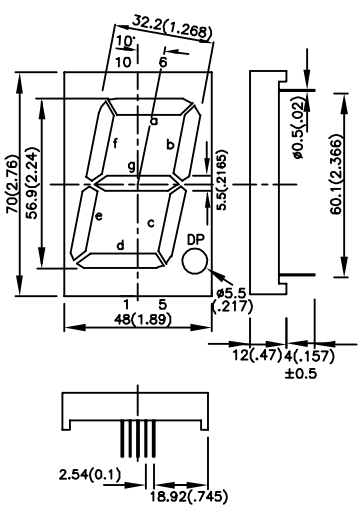
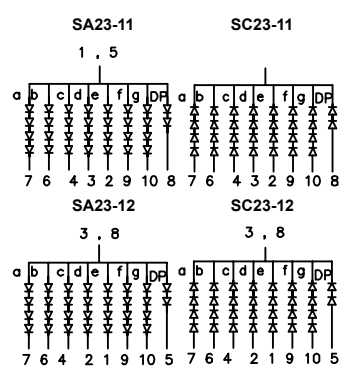
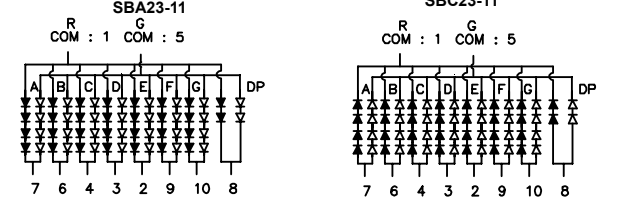
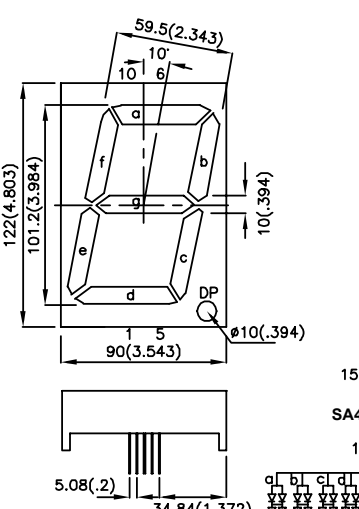
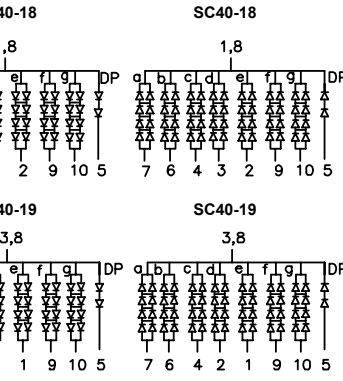

NOTES:
 1. All dimensions are in millimeters(inches).
 2. Tolerance is ±0.25mm(0.01") unless otherwise noted.

SINGLE DIGIT 7-SEGMENT THROUGH-HOLE DISPLAY

PART NUMBER		MATERIAL	λ D (nm)	Iv (ucd) @10mA		DIMENSION
COMMON ANODE	COMMON CATHODE			MIN.	TYP.	
SA23-11SEKWA SA23-12SEKWA	SC23-11SEKWA SC23-12SEKWA	AlGaInP	601	75000	368000	<p>2.24 inch (56.9mm), Gray Face, White Segment</p>   
SA23-11SURKWA SA23-12SURKWA	SC23-11SURKWA SC23-12SURKWA	AlGaInP	630	26000	270000	
SA23-11SYKWA SA23-12SYKWA	SC23-11SYKWA SC23-12SYKWA	AlGaInP	590	75000	287000	
SA23-11CGKWA SA23-12CGKWA	SC23-11CGKWA SC23-12CGKWA	AlGaInP	570	44000	200300	
SBA23-11 SURKCGKWA	SBC23-11 SURKCGKWA	AlGaInP	630	44000	270000	
		AlGaInP	570	44000	200300	
SA40-18SEKWA SA40-19SEKWA	SC40-18SEKWA SC40-19SEKWA	AlGaInP	601	75000	310000	<p>3.984 inch (101.2mm), Gray Face, White Segment</p>  
SA40-18SURKWA SA40-19SURKWA	SC40-18SURKWA SC40-19SURKWA	AlGaInP	630	26000	123000	
SA40-18SYKWA SA40-19SYKWA	SC40-18SYKWA SC40-19SYKWA	AlGaInP	590	44000	129000	
SA40-18CGKWA SA40-19CGKWA	SC40-18CGKWA SC40-19CGKWA	AlGaInP	570	26000	101000	

NOTES:
 1. All dimensions are in millimeters(inches).
 2. Tolerance is ±0.25mm(0.01") unless otherwise noted.

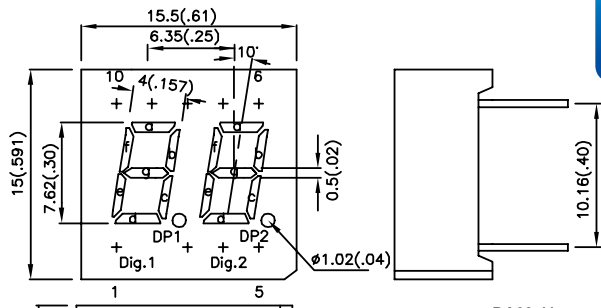
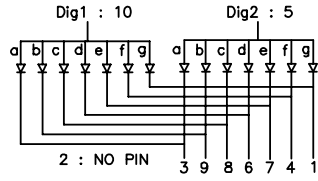
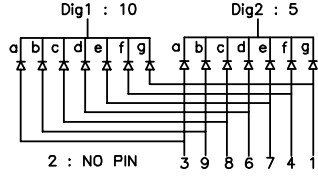
DUAL DIGIT 7-SEGMENT THROUGH-HOLE DISPLAY

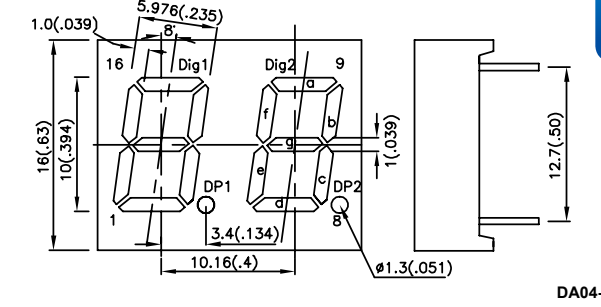
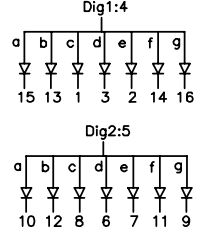
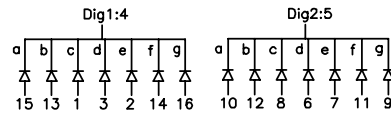
PART NUMBER		MATERIAL	λ D (nm)	Iv (ucd) @10mA		DIMENSION
COMMON ANODE	COMMON CATHODE			MIN.	TYP.	
DA03-11SEKWA	DC03-11SEKWA	AlGaInP	601	44000	154400	<p>0.3 inch (7.62mm), Gray Face, White Segment</p>  <p>DX03</p>  <p>DA03-11</p>  <p>DA03-11 Pinout: Dig1 : 10 (a, b, c, d, e, f, g, 2: NO PIN, 3, 9, 8, 6, 7, 4, 1) Dig2 : 5 (a, b, c, d, e, f, g)</p>  <p>DC03-11 Pinout: Dig1 : 10 (a, b, c, d, e, f, g, 2: NO PIN, 3, 9, 8, 6, 7, 4, 1) Dig2 : 5 (a, b, c, d, e, f, g)</p>
DA03-11SURKWA	DC03-11SURKWA	AlGaInP	630	12000	18500	
DA03-11SYKWA	DC03-11SYKWA	AlGaInP	590	44000	103500	
DA03-11CGKWA	DC03-11CGKWA	AlGaInP	570	12000	46000	
DA04-11SEKWA	DC04-11SEKWA	AlGaInP	601	44000	160700	<p>0.394 inch (10mm), Gray Face, White Segment</p>  <p>DX04</p>  <p>DA04-11</p>  <p>DA04-11 Pinout: Dig1:4 (15, 13, 1, 3, 2, 14, 16) Dig2:5 (10, 12, 8, 6, 7, 11, 9)</p>  <p>DC04-11 Pinout: Dig1:4 (15, 13, 1, 3, 2, 14, 16) Dig2:5 (10, 12, 8, 6, 7, 11, 9)</p>
DA04-11SURKWA	DC04-11SURKWA	AlGaInP	630	12000	31600	
DA04-11SYKWA	DC04-11SYKWA	AlGaInP	590	44000	92400	
DA04-11CGKWA	DC04-11CGKWA	AlGaInP	570	8000	25000	

NOTES:
 1. All dimensions are in millimeters(inches).
 2. Tolerance is ±0.25mm(0.01") unless otherwise noted.

DUAL DIGIT 7-SEGMENT THROUGH-HOLE DISPLAY

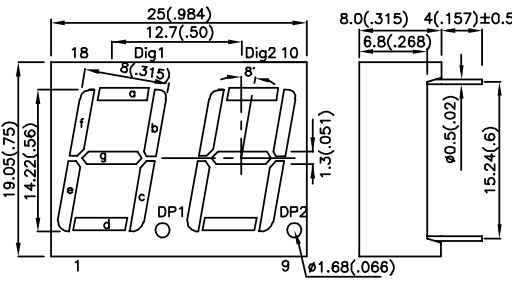
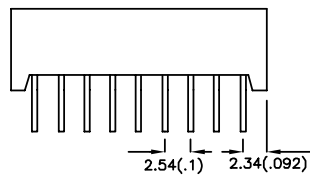
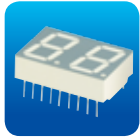
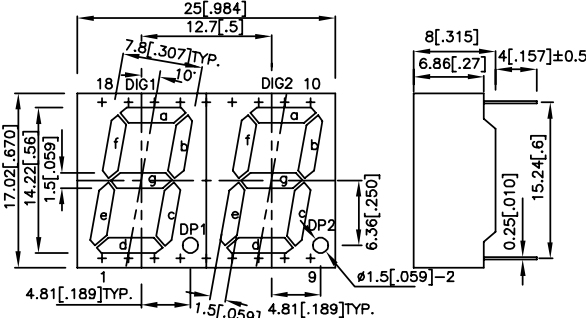
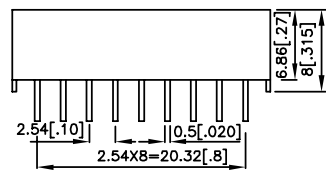
PART NUMBER		MATERIAL	λ D (nm)	Iv (ucd) @10mA		DIMENSION
COMMON ANODE	COMMON CATHODE			MIN.	TYP.	
DA56-11SEKWA	DC56-11SEKWA	AlGaInP	● 601	18000	78700	<p>0.56 inch (14.22mm), Gray Face, White Segment</p>  <p>DX56-11</p>   <p>DA56-11</p> <p>Dig1 : 14 a b c d e f g DP1 16 15 3 2 1 18 17 4</p> <p>Dig2 : 13 a b c d e f g DP2 11 10 8 6 5 12 7 9</p> <p>DC56-11</p> <p>Dig1 : 14 a b c d e f g DP1 16 15 3 2 1 18 17 4</p> <p>Dig2 : 13 a b c d e f g DP2 11 10 8 6 5 12 7 9</p>
DA56-11SURKWA	DC56-11SURKWA	AlGaInP	● 630	12000	51900	
DA56-11SYKWA	DC56-11SYKWA	AlGaInP	● 590	18000	54000	
DA56-11CGKWA	DC56-11CGKWA	AlGaInP	● 570	12000	35000	
DA56-51SEKWA	DC56-51SEKWA	AlGaInP	● 601	44000	175300	<p>0.56 inch (14.22mm), Gray Face, White Segment</p>  <p>DX56-51</p>   <p>DA56-51</p> <p>DIG1:14 a b c d e f g DP1 16 15 3 2 1 18 17 4</p> <p>DIG2:13 a b c d e f g DP2 11 10 8 6 5 12 7 9</p> <p>DC56-51</p> <p>DIG1:14 a b c d e f g DP1 16 15 3 2 1 18 17 4</p> <p>DIG2:13 a b c d e f g DP2 11 10 8 6 5 12 7 9</p>
DA56-51SURKWA	DC56-51SURKWA	AlGaInP	● 630	18000	43900	
DA56-51SYKWA	DC56-51SYKWA	AlGaInP	● 590	18000	44000	
DA56-51CGKWA	DC56-51CGKWA	AlGaInP	● 570	12000	35000	

NOTES:

1. All dimensions are in millimeters(inches).
2. Tolerance is ±0.25mm(0.01") unless otherwise noted.

DUAL DIGIT 7-SEGMENT THROUGH-HOLE DISPLAY

PART NUMBER		MATERIAL	λ D (nm)	Iv (ucd) @10mA		DIMENSION
COMMON ANODE	COMMON CATHODE			MIN.	TYP.	
DA08-11SEKWA	DC08-11SEKWA	AlGaInP	601	44000	197500	<p>0.8 inch (20.32mm), Gray Face, White Segment</p> <p>DA08-11 Dig1 : 14 Dig2 : 13 a b c d e f g DP1 a b c d e f g DP2 16 15 3 2 1 18 17 4 11 10 8 6 5 12 7 9</p> <p>DC08-11 Dig1 : 14 Dig2 : 13 a b c d e f g DP1 a b c d e f g DP2 16 15 3 2 1 18 17 4 11 10 8 6 5 12 7 9</p>
DA08-11SURKWA	DC08-11SURKWA	AlGaInP	630	18000	60600	
DA08-11SYKWA	DC08-11SYKWA	AlGaInP	590	26000	78000	
DA08-11CGKWA	DC08-11CGKWA	AlGaInP	570	12000	34400	

THREE DIGIT 7-SEGMENT THROUGH-HOLE DISPLAY

PART NUMBER		MATERIAL	λ D (nm)	Iv (ucd) @10mA		DIMENSION
COMMON ANODE	COMMON CATHODE			MIN.	TYP.	
BA04-11SEKWA	BC04-11SEKWA	AlGaInP	601	18000	160700	<p>0.4 inch (10.2mm), Gray Face, White Segment</p> <p>BA04-11 Dig2 Dig3 4 5 9 a b c d e f g a b c d e f g a b c d e f g 23 21 1 3 2 22 24 18 20 8 6 7 19 17 14 13 12 10 11 15 16</p> <p>BC04-11 Dig1 Dig2 Dig3 4 5 9 a b c d e f g a b c d e f g a b c d e f g 23 21 1 3 2 22 24 18 20 8 6 7 19 17 14 13 12 10 11 15 16</p>
BA04-11SURKWA	BC04-11SURKWA	AlGaInP	630	12000	44900	
BA04-11SYKWA	BC04-11SYKWA	AlGaInP	590	44000	92400	
BA04-11CGKWA	BC04-11CGKWA	AlGaInP	570	8000	25000	

NOTES:
 1. All dimensions are in millimeters(inches).
 2. Tolerance is ±0.25mm(0.01") unless otherwise noted.

THREE DIGIT 7-SEGMENT THROUGH-HOLE DISPLAY

PART NUMBER		MATERIAL	λ D (nm)	Iv (ucd) @10mA		DIMENSION
COMMON ANODE	COMMON CATHODE			MIN.	TYP.	
BA56-11SEKWA BA56-12SEKWA BA56-13SEKWA	BC56-11SEKWA BC56-12SEKWA BC56-13SEKWA	AlGaInP	601	26000	114800	<p>0.56 inch (14.22mm), Gray Face, White Segment</p> <p>BA56/BC56-11 BA56/BC56-13</p>
BA56-11SURKWA BA56-12SURKWA BA56-13SURKWA	BC56-11SURKWA BC56-12SURKWA BC56-13SURKWA	AlGaInP	630	12000	49000	<p>BA56-13 Dig1 : 26 Dig2 : 8,21 Dig3 : 15</p> <p>BC56-13 Dig1 : 26 Dig2 : 8,21 Dig3 : 15</p>
BA56-11SYKWA BA56-12SYKWA BA56-13SYKWA	BC56-11SYKWA BC56-12SYKWA BC56-13SYKWA	AlGaInP	590	18000	54000	<p>BA56/BC56-12</p>
BA56-11CGKWA BA56-12CGKWA BA56-13CGKWA	BC56-11CGKWA BC56-12CGKWA BC56-13CGKWA	AlGaInP	570	12000	35000	<p>BA56-12 Dig1 : 12 Dig2 : 9 Dig3 : 8</p> <p>BC56-12 Dig1 : 12 Dig2 : 9 Dig3 : 8</p>

NOTES:
 1. All dimensions are in millimeters(inches).
 2. Tolerance is ±0.25mm(0.01") unless otherwise noted.

FOUR DIGIT 7-SEGMENT THROUGH-HOLE DISPLAY

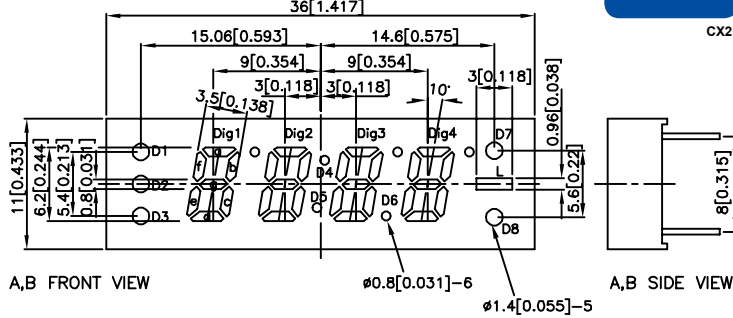
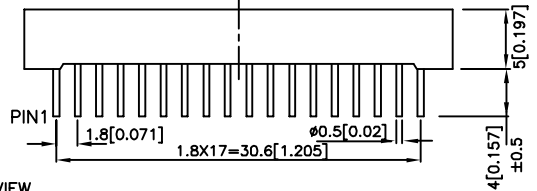
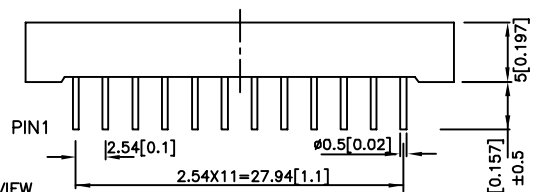
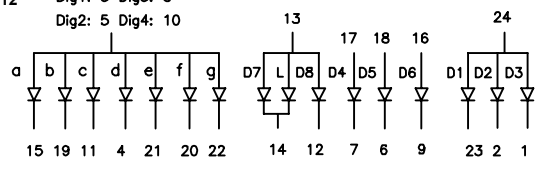
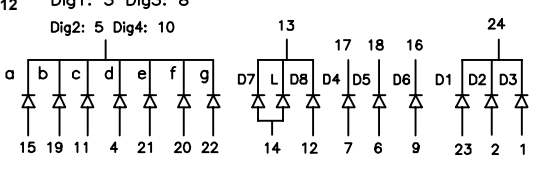
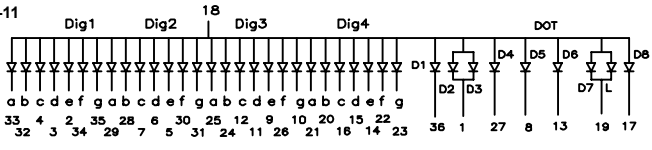
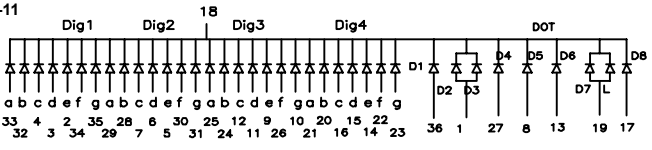
PART NUMBER		MATERIAL	λ D (nm)	Iv (ucd) @10mA		DIMENSION
COMMON ANODE	COMMON CATHODE			MIN.	TYP.	
CA25-11SEKWA CA25-12SEKWA	CC25-11SEKWA CC25-12SEKWA	AlGaInP	601	44000	159400	<p>0.244 inch (6.2mm), Gray Face, White Segment</p> <p>A: CA/CC25-11 B: CA/CC25-12</p>  <p>CX25</p>  <p>A,B FRONT VIEW A,B SIDE VIEW</p>
CA25-11SURKWA CA25-12SURKWA	CC25-11SURKWA CC25-12SURKWA	AlGaInP	630	12000	32000	 <p>A END VIEW</p>  <p>B END VIEW</p>
CA25-11SYKWA CA25-12SYKWA	CC25-11SYKWA CC25-12SYKWA	AlGaInP	590	44000	111500	<p>CA25-12 Dig1: 3 Dig3: 8 Dig2: 5 Dig4: 10</p>  <p>CC25-12 Dig1: 3 Dig3: 8 Dig2: 5 Dig4: 10</p> 
CA25-11CGKWA CA25-12CGKWA	CC25-11CGKWA CC25-12CGKWA	AlGaInP	570	12000	34000	<p>CA25-11 Dig1 Dig2 18 Dig3 Dig4 DOT</p>  <p>CC25-11 Dig1 Dig2 18 Dig3 Dig4 DOT</p> 

NOTES:
 1. All dimensions are in millimeters(inches).
 2. Tolerance is ±0.25mm(0.01") unless otherwise noted.

FOUR DIGIT 7-SEGMENT THROUGH-HOLE DISPLAY

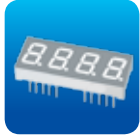
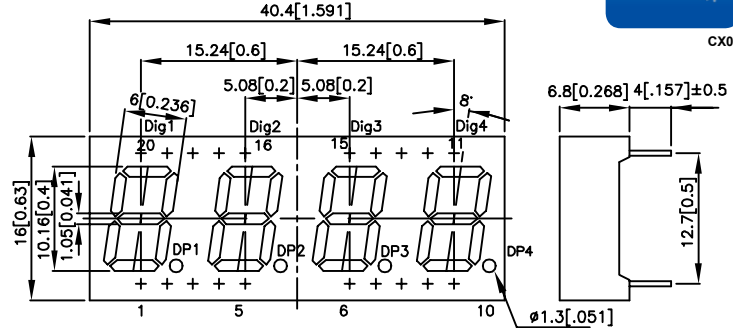
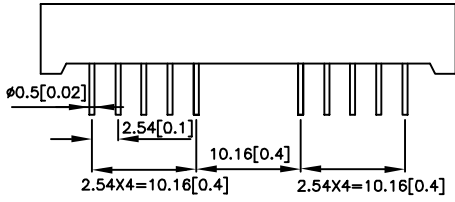
PART NUMBER		MATERIAL	λ D (nm)	Iv (ucd) @10mA		DIMENSION
COMMON ANODE	COMMON CATHODE			MIN.	TYP.	
CA04-41SEKWA	CC04-41SEKWA	AlGaInP	601	44000	135000	<p>0.4 inch (10.16mm), Gray Face, White Segment</p>  <p>CX04</p>  
CA04-41SURKWA	CC04-41SURKWA	AlGaInP	630	26000	87000	
CA04-41SYKWA	CC04-41SYKWA	AlGaInP	590	44000	110000	
CA04-41CGKWA	CC04-41CGKWA	AlGaInP	570	8000	33000	

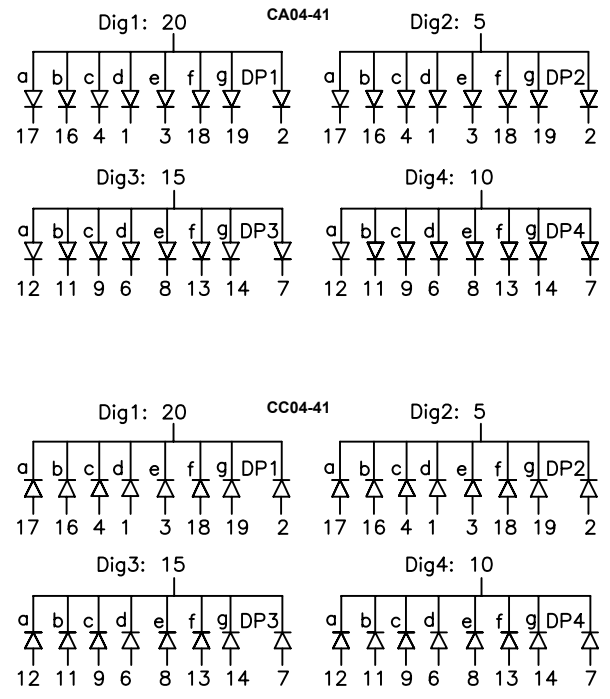



NOTES:
 1. All dimensions are in millimeters(inches).
 2. Tolerance is ±0.25mm(0.01") unless otherwise noted.

FOUR DIGIT 7-SEGMENT THROUGH-HOLE DISPLAY

PART NUMBER		MATERIAL	λ D (nm)	Iv (ucd) @10mA		DIMENSION
COMMON ANODE	COMMON CATHODE			MIN.	TYP.	
CA56-11SEKWA CA56-12SEKWA CA56-21SEKWA	CC56-11SEKWA CC56-12SEKWA CC56-21SEKWA	AlGaInP	601	26000	114800	<p>0.56 inch (14.22mm), Gray Face, White Segment</p> <p>A:CA/CC56-11 B:CA/CC56-12 C:CA/CC56-21</p> <p>50.3[1.98]</p> <p>12.7[.5] 12.7[.5] 12.7[.5]</p> <p>36 8.0[.315] 19</p> <p>14.2[.559] 19[.748]</p> <p>1 18</p> <p>A,B,C FRONT VIEW</p> <p>18</p> <p>ø1.5[.059]</p> <p>8.1[.319] B.1[.319] 4[.157]±0.5</p> <p>PIN1</p> <p>A END VIEW</p> <p>2.54[.1] ø0.5[.02]</p> <p>15.24[.6] A,B,C SIDE VIEW</p> <p>8.1[.319] B.1[.319] 4[.157]±0.5</p> <p>PIN1</p> <p>B,C END VIEW</p> <p>2.54[.1] ø0.5[.02]</p> <p>CA56-11 CC56-11</p> <p>Dig1: 32 Dig2: 31 Dig1: 32 Dig2: 31</p> <p>a b c d e f g DP1 a b c d e f g DP2 a b c d e f g DP1 a b c d e f g DP2</p> <p>34 33 3 2 1 36 35 4 29 28 8 6 5 30 7 9 34 33 3 2 1 36 35 4 29 28 8 6 5 30 7 9</p> <p>Dig3: 23 Dig4: 22 Dig3: 23 Dig4: 22</p> <p>a b c d e f g DP3 a b c d e f g DP4 a b c d e f g DP3 a b c d e f g DP4</p> <p>25 24 12 11 10 27 26 13 20 19 17 15 14 21 16 18 25 24 12 11 10 27 26 13 20 19 17 15 14 21 16 18</p> <p>CA56-12 CC56-12</p> <p>Dig1: 12 Dig2: 9 Dig1: 12 Dig2: 9</p> <p>a b c d e f g DP1 a b c d e f g DP2 a b c d e f g DP1 a b c d e f g DP2</p> <p>11 7 4 2 1 10 5 3 11 7 4 2 1 10 5 3 11 7 4 2 1 10 5 3 11 7 4 2 1 10 5 3</p> <p>Dig3: 8 Dig4: 6 Dig3: 8 Dig4: 6</p> <p>a b c d e f g DP3 a b c d e f g DP4 a b c d e f g DP3 a b c d e f g DP4</p> <p>11 7 4 2 1 10 5 3 11 7 4 2 1 10 5 3 11 7 4 2 1 10 5 3 11 7 4 2 1 10 5 3</p> <p>CA56-21 CC56-21</p> <p>Dig1: 12 Dig2: 9 Dig1: 12 Dig2: 9</p> <p>a b c d e f g DP5 a b c d e f g DP6 a b c d e f g DP5 a b c d e f g DP6</p> <p>11 7 4 2 1 10 5 3 11 7 4 2 1 10 5 3 11 7 4 2 1 10 5 3 11 7 4 2 1 10 5 3</p> <p>Dig3: 8 Dig4: 6 Dig3: 8 Dig4: 6</p> <p>a b c d e f g DP5 a b c d e f g DP6 a b c d e f g DP5 a b c d e f g DP6</p> <p>11 7 4 2 1 10 5 3 11 7 4 2 1 10 5 3 11 7 4 2 1 10 5 3 11 7 4 2 1 10 5 3</p>
CA56-11SURKWA CA56-12SURKWA CA56-21SURKWA	CC56-11SURKWA CC56-12SURKWA CC56-21SURKWA	AlGaInP	630	12000	58500	<p>8.1[.319] B.1[.319] 4[.157]±0.5</p> <p>PIN1</p> <p>A END VIEW</p> <p>2.54[.1] ø0.5[.02]</p> <p>15.24[.6] A,B,C SIDE VIEW</p> <p>8.1[.319] B.1[.319] 4[.157]±0.5</p> <p>PIN1</p> <p>B,C END VIEW</p> <p>2.54[.1] ø0.5[.02]</p> <p>CA56-11 CC56-11</p> <p>Dig1: 32 Dig2: 31 Dig1: 32 Dig2: 31</p> <p>a b c d e f g DP1 a b c d e f g DP2 a b c d e f g DP1 a b c d e f g DP2</p> <p>34 33 3 2 1 36 35 4 29 28 8 6 5 30 7 9 34 33 3 2 1 36 35 4 29 28 8 6 5 30 7 9</p> <p>Dig3: 23 Dig4: 22 Dig3: 23 Dig4: 22</p> <p>a b c d e f g DP3 a b c d e f g DP4 a b c d e f g DP3 a b c d e f g DP4</p> <p>25 24 12 11 10 27 26 13 20 19 17 15 14 21 16 18 25 24 12 11 10 27 26 13 20 19 17 15 14 21 16 18</p> <p>CA56-12 CC56-12</p> <p>Dig1: 12 Dig2: 9 Dig1: 12 Dig2: 9</p> <p>a b c d e f g DP1 a b c d e f g DP2 a b c d e f g DP1 a b c d e f g DP2</p> <p>11 7 4 2 1 10 5 3 11 7 4 2 1 10 5 3 11 7 4 2 1 10 5 3 11 7 4 2 1 10 5 3</p> <p>Dig3: 8 Dig4: 6 Dig3: 8 Dig4: 6</p> <p>a b c d e f g DP3 a b c d e f g DP4 a b c d e f g DP3 a b c d e f g DP4</p> <p>11 7 4 2 1 10 5 3 11 7 4 2 1 10 5 3 11 7 4 2 1 10 5 3 11 7 4 2 1 10 5 3</p> <p>CA56-21 CC56-21</p> <p>Dig1: 12 Dig2: 9 Dig1: 12 Dig2: 9</p> <p>a b c d e f g DP5 a b c d e f g DP6 a b c d e f g DP5 a b c d e f g DP6</p> <p>11 7 4 2 1 10 5 3 11 7 4 2 1 10 5 3 11 7 4 2 1 10 5 3 11 7 4 2 1 10 5 3</p> <p>Dig3: 8 Dig4: 6 Dig3: 8 Dig4: 6</p> <p>a b c d e f g DP5 a b c d e f g DP6 a b c d e f g DP5 a b c d e f g DP6</p> <p>11 7 4 2 1 10 5 3 11 7 4 2 1 10 5 3 11 7 4 2 1 10 5 3 11 7 4 2 1 10 5 3</p>
CA56-11SYKWA CA56-12SYKWA CA56-21SYKWA	CC56-11SYKWA CC56-12SYKWA CC56-21SYKWA	AlGaInP	590	12000	59000	<p>8.1[.319] B.1[.319] 4[.157]±0.5</p> <p>PIN1</p> <p>A END VIEW</p> <p>2.54[.1] ø0.5[.02]</p> <p>15.24[.6] A,B,C SIDE VIEW</p> <p>8.1[.319] B.1[.319] 4[.157]±0.5</p> <p>PIN1</p> <p>B,C END VIEW</p> <p>2.54[.1] ø0.5[.02]</p> <p>CA56-11 CC56-11</p> <p>Dig1: 32 Dig2: 31 Dig1: 32 Dig2: 31</p> <p>a b c d e f g DP1 a b c d e f g DP2 a b c d e f g DP1 a b c d e f g DP2</p> <p>34 33 3 2 1 36 35 4 29 28 8 6 5 30 7 9 34 33 3 2 1 36 35 4 29 28 8 6 5 30 7 9</p> <p>Dig3: 23 Dig4: 22 Dig3: 23 Dig4: 22</p> <p>a b c d e f g DP3 a b c d e f g DP4 a b c d e f g DP3 a b c d e f g DP4</p> <p>25 24 12 11 10 27 26 13 20 19 17 15 14 21 16 18 25 24 12 11 10 27 26 13 20 19 17 15 14 21 16 18</p> <p>CA56-12 CC56-12</p> <p>Dig1: 12 Dig2: 9 Dig1: 12 Dig2: 9</p> <p>a b c d e f g DP1 a b c d e f g DP2 a b c d e f g DP1 a b c d e f g DP2</p> <p>11 7 4 2 1 10 5 3 11 7 4 2 1 10 5 3 11 7 4 2 1 10 5 3 11 7 4 2 1 10 5 3</p> <p>Dig3: 8 Dig4: 6 Dig3: 8 Dig4: 6</p> <p>a b c d e f g DP3 a b c d e f g DP4 a b c d e f g DP3 a b c d e f g DP4</p> <p>11 7 4 2 1 10 5 3 11 7 4 2 1 10 5 3 11 7 4 2 1 10 5 3 11 7 4 2 1 10 5 3</p> <p>CA56-21 CC56-21</p> <p>Dig1: 12 Dig2: 9 Dig1: 12 Dig2: 9</p> <p>a b c d e f g DP5 a b c d e f g DP6 a b c d e f g DP5 a b c d e f g DP6</p> <p>11 7 4 2 1 10 5 3 11 7 4 2 1 10 5 3 11 7 4 2 1 10 5 3 11 7 4 2 1 10 5 3</p> <p>Dig3: 8 Dig4: 6 Dig3: 8 Dig4: 6</p> <p>a b c d e f g DP5 a b c d e f g DP6 a b c d e f g DP5 a b c d e f g DP6</p> <p>11 7 4 2 1 10 5 3 11 7 4 2 1 10 5 3 11 7 4 2 1 10 5 3 11 7 4 2 1 10 5 3</p>
CA56-11CGKWA CA56-12CGKWA CA56-21CGKWA	CC56-11CGKWA CC56-12CGKWA CC56-21CGKWA	AlGaInP	570	8000	35000	<p>8.1[.319] B.1[.319] 4[.157]±0.5</p> <p>PIN1</p> <p>A END VIEW</p> <p>2.54[.1] ø0.5[.02]</p> <p>15.24[.6] A,B,C SIDE VIEW</p> <p>8.1[.319] B.1[.319] 4[.157]±0.5</p> <p>PIN1</p> <p>B,C END VIEW</p> <p>2.54[.1] ø0.5[.02]</p> <p>CA56-11 CC56-11</p> <p>Dig1: 32 Dig2: 31 Dig1: 32 Dig2: 31</p> <p>a b c d e f g DP1 a b c d e f g DP2 a b c d e f g DP1 a b c d e f g DP2</p> <p>34 33 3 2 1 36 35 4 29 28 8 6 5 30 7 9 34 33 3 2 1 36 35 4 29 28 8 6 5 30 7 9</p> <p>Dig3: 23 Dig4: 22 Dig3: 23 Dig4: 22</p> <p>a b c d e f g DP3 a b c d e f g DP4 a b c d e f g DP3 a b c d e f g DP4</p> <p>25 24 12 11 10 27 26 13 20 19 17 15 14 21 16 18 25 24 12 11 10 27 26 13 20 19 17 15 14 21 16 18</p> <p>CA56-12 CC56-12</p> <p>Dig1: 12 Dig2: 9 Dig1: 12 Dig2: 9</p> <p>a b c d e f g DP1 a b c d e f g DP2 a b c d e f g DP1 a b c d e f g DP2</p> <p>11 7 4 2 1 10 5 3 11 7 4 2 1 10 5 3 11 7 4 2 1 10 5 3 11 7 4 2 1 10 5 3</p> <p>Dig3: 8 Dig4: 6 Dig3: 8 Dig4: 6</p> <p>a b c d e f g DP3 a b c d e f g DP4 a b c d e f g DP3 a b c d e f g DP4</p> <p>11 7 4 2 1 10 5 3 11 7 4 2 1 10 5 3 11 7 4 2 1 10 5 3 11 7 4 2 1 10 5 3</p> <p>CA56-21 CC56-21</p> <p>Dig1: 12 Dig2: 9 Dig1: 12 Dig2: 9</p> <p>a b c d e f g DP5 a b c d e f g DP6 a b c d e f g DP5 a b c d e f g DP6</p> <p>11 7 4 2 1 10 5 3 11 7 4 2 1 10 5 3 11 7 4 2 1 10 5 3 11 7 4 2 1 10 5 3</p> <p>Dig3: 8 Dig4: 6 Dig3: 8 Dig4: 6</p> <p>a b c d e f g DP5 a b c d e f g DP6 a b c d e f g DP5 a b c d e f g DP6</p> <p>11 7 4 2 1 10 5 3 11 7 4 2 1 10 5 3 11 7 4 2 1 10 5 3 11 7 4 2 1 10 5 3</p>

NOTES:
 1. All dimensions are in millimeters(inches).
 2. Tolerance is ±0.25mm(0.01") unless otherwise noted.

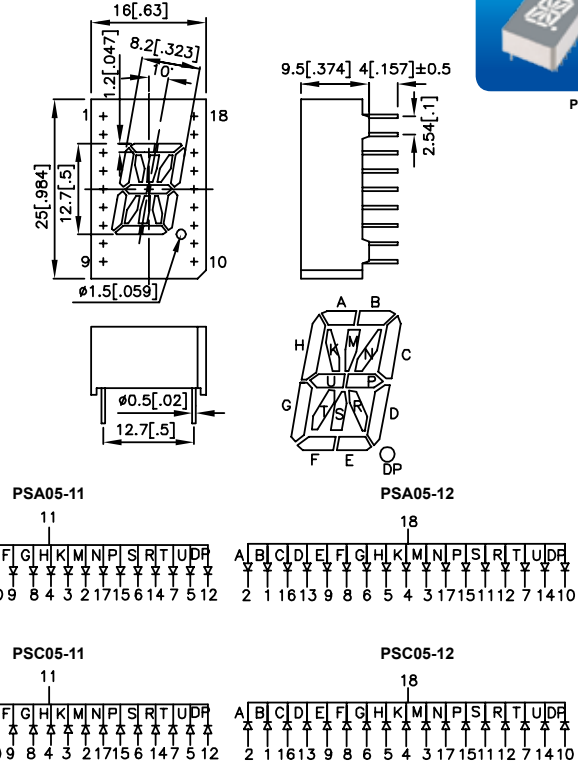
ALPHANUMERIC THROUGH-HOLE DISPLAY

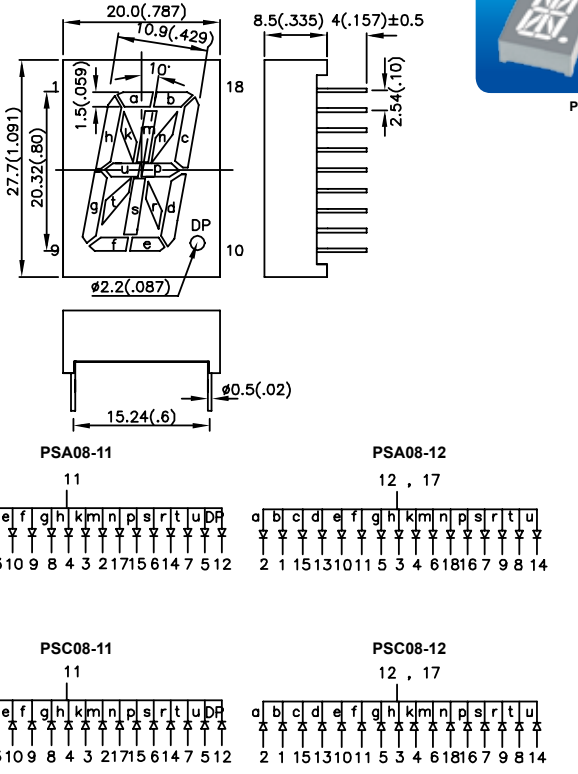
PART NUMBER		MATERIAL	λ D (nm)	Iv (ucd) @10mA		DIMENSION
COMMON ANODE	COMMON CATHODE			MIN.	TYP.	
PSA05-11SEKWA PSA05-12SEKWA	PSC05-11SEKWA PSC05-12SEKWA	AlGaInP	601	18000	64900	<p>0.5 inch (12.7mm), Gray Face, White Segment</p>  <p>PSX05</p>  <p>PSA05-11 PSA05-12</p> <p>11 18</p> <p>A B C D E F G H K M N P S R T U DP</p> <p>1 18 16 13 10 9 8 4 3 2 17 15 6 14 7 5 12</p> <p>2 1 16 13 9 8 6 5 4 3 17 15 11 12 7 14 10</p> <p>PSC05-11 PSC05-12</p> <p>11 18</p> <p>A B C D E F G H K M N P S R T U DP</p> <p>1 18 16 13 10 9 8 4 3 2 17 15 6 14 7 5 12</p> <p>2 1 16 13 9 8 6 5 4 3 17 15 11 12 7 14 10</p>
PSA05-11SURKWA PSA05-12SURKWA	PSC05-11SURKWA PSC05-12SURKWA	AlGaInP	630	12000	23800	
PSA05-11SYKWA PSA05-12SYKWA	PSC05-11SYKWA PSC05-12SYKWA	AlGaInP	590	12000	44000	
PSA05-11CGKWA PSA05-12CGKWA	PSC05-11CGKWA PSC05-12CGKWA	AlGaInP	570	8000	22400	
PSA08-11SEKWA PSA08-12SEKWA	PSC08-11SEKWA PSC08-12SEKWA	AlGaInP	601	26000	102000	<p>0.8 inch (20.32mm), Gray Face, White Segment</p>  <p>PSX08</p>  <p>PSA08-11 PSA08-12</p> <p>11 12, 17</p> <p>a b c d e f g h k m n p s r t u DP</p> <p>1 18 16 13 10 9 8 4 3 2 17 15 6 14 7 5 12</p> <p>2 1 15 13 10 11 5 3 4 6 18 16 7 9 8 14</p> <p>PSC08-11 PSC08-12</p> <p>11 12, 17</p> <p>a b c d e f g h k m n p s r t u DP</p> <p>1 18 16 13 10 9 8 4 3 2 17 15 6 14 7 5 12</p> <p>2 1 15 13 10 11 5 3 4 6 18 16 7 9 8 14</p>
PSA08-11SURKWA PSA08-12SURKWA	PSC08-11SURKWA PSC08-12SURKWA	AlGaInP	630	12000	39700	
PSA08-11SYKWA PSA08-12SYKWA	PSC08-11SYKWA PSC08-12SYKWA	AlGaInP	590	26000	84000	
PSA08-11CGKWA PSA08-12CGKWA	PSC08-11CGKWA PSC08-12CGKWA	AlGaInP	570	8000	31700	

NOTES:
 1. All dimensions are in millimeters(inches).
 2. Tolerance is ±0.25mm(0.01") unless otherwise noted.

ALPHANUMERIC THROUGH-HOLE DISPLAY

PART NUMBER		MATERIAL	λ D (nm)	Iv (ucd) @10mA		DIMENSION
COMMON ANODE	COMMON CATHODE			MIN.	TYP.	
PSA12-11SEKWA	PSC12-11SEKWA	AlGaInP	601	26000	107000	<p>1.2 inch (30.48mm), Gray Face, White Segment</p> <p>PSA12-11</p> <p>PSC12-11</p>
PSA12-11SURKWA	PSC12-11SURKWA	AlGaInP	630	18000	63200	
PSA12-11SYKWA	PSC12-11SYKWA	AlGaInP	590	26000	101000	
PSA12-11CGKWA	PSC12-11CGKWA	AlGaInP	570	12000	37200	
PSA23-11SEKWA	PSC23-11SEKWA	AlGaInP	601	44000	163000	<p>2.24 inch (56.8mm), Gray Face, White Segment</p> <p>PSA23-11</p> <p>PSC23-11</p>
PSA23-11SURKWA	PSC23-11SURKWA	AlGaInP	630	18000	73000	
PSA23-11SYKWA	PSC23-11SYKWA	AlGaInP	590	44000	173300	
PSA23-11CGKWA	PSC23-11CGKWA	AlGaInP	570	8000	17000	

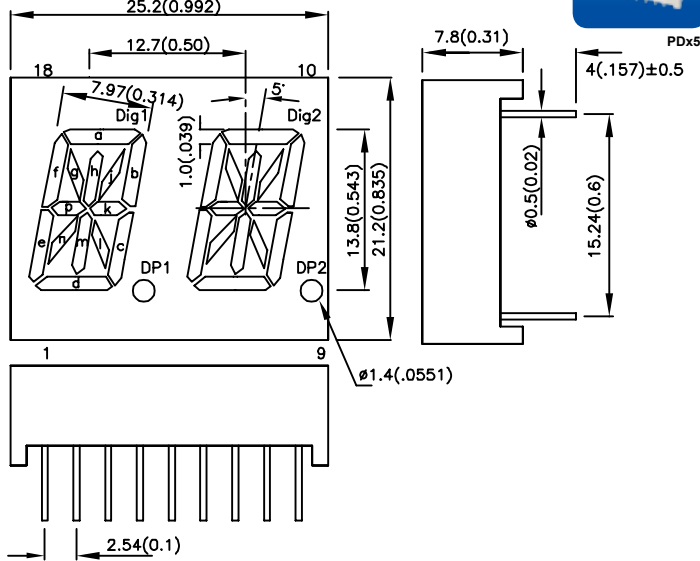
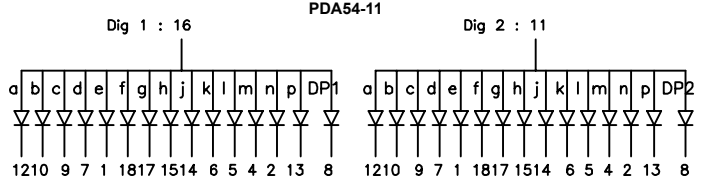
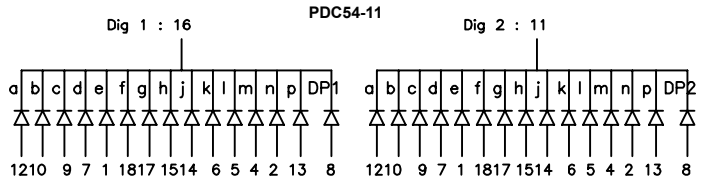
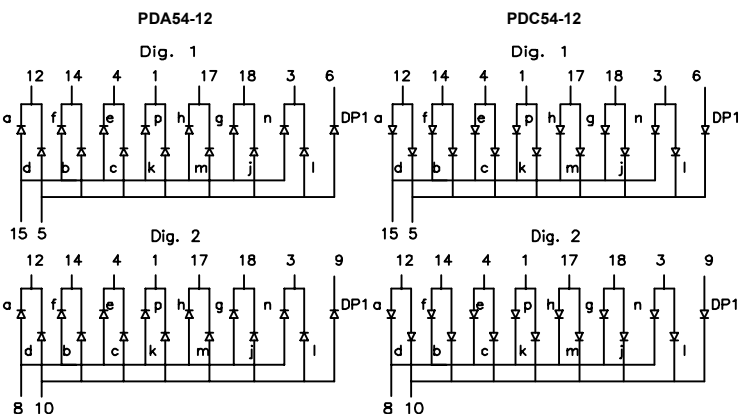

NOTES:
 1. All dimensions are in millimeters(inches).
 2. Tolerance is ±0.25mm(0.01") unless otherwise noted.

ALPHANUMERIC THROUGH-HOLE DISPLAY

PART NUMBER		MATERIAL	λ D (nm)	Iv (ucd) @10mA		DIMENSION
COMMON ANODE	COMMON CATHODE			MIN.	TYP.	
PDA54-11SEKWA PDA54-12SEKWA	PDC54-11SEKWA PDC54-12SEKWA	AlGaInP	● 601	18000	77800	<p>0.543inch (13.8mm), Gray Face, White Segment</p>      <p>PIN 2,7,11,13,16 NO CONNECTION</p>
PDA54-11SURKWA PDA54-12SURKWA	PDC54-11SURKWA PDC54-12SURKWA	AlGaInP	● 630	12000	46000	
PDA54-11SYKWA PDA54-12SYKWA	PDC54-11SYKWA PDC54-12SYKWA	AlGaInP	● 590	12000	45600	
PDA54-11CGKWA PDA54-12CGKWA	PDC54-11CGKWA PDC54-12CGKWA	AlGaInP	● 570	8000	27800	

NOTES:
 1. All dimensions are in millimeters(inches).
 2. Tolerance is $\pm 0.25\text{mm}(0.01\text{'})$ unless otherwise noted.

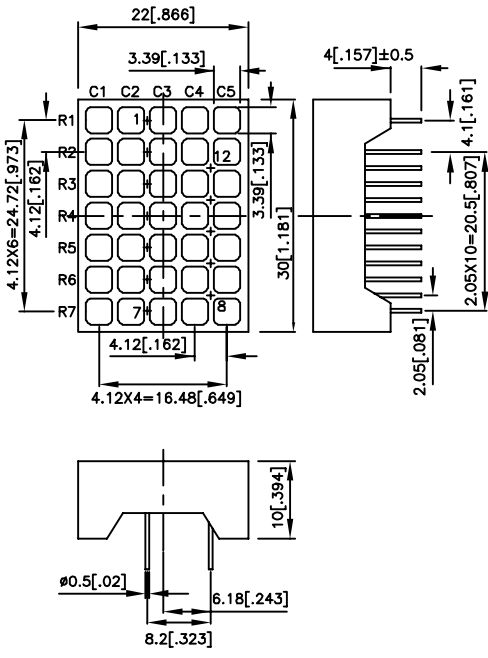
DOT MATRIX

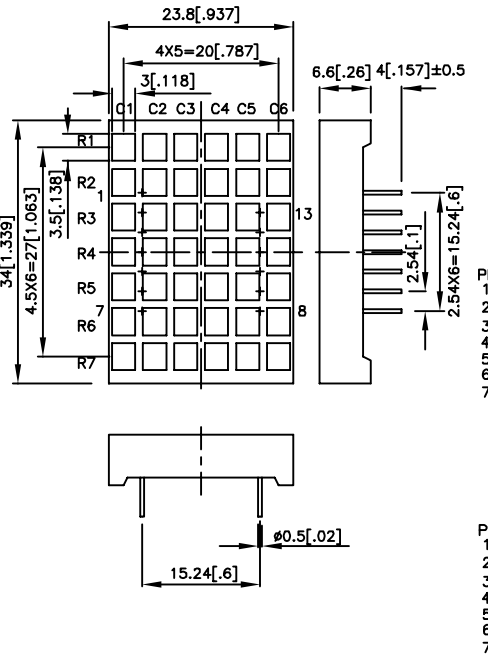
PART NUMBER		MATERIAL	λ D (nm)	Iv (ucd) @10mA		DIMENSION
COLUMN ANODE	COLUMN CATHODE			MIN.	TYP.	
TA12-41SEKWB	TC12-41SEKWB	AlGaInP	● 601	75000	238900	<p>1.107 inch (28.11mm), 5x7, Black Face, White Dot</p>  <p style="text-align: right;">TX12-41</p>  <p style="text-align: center;">TA12-41</p> <p>PIN 12 11 10 9 8 C1 C2 C3 C4 C5</p> <p>PIN 1 R1 2 R2 3 R3 4 R4 5 R5 6 R6 7 R7</p> <p style="text-align: center;">TC12-41</p> <p>PIN 12 11 10 9 8 C1 C2 C3 C4 C5</p> <p>PIN 1 R1 2 R2 3 R3 4 R4 5 R5 6 R6 7 R7</p>
TA12-41SURKWB	TC12-41SURKWB	AlGaInP	● 630	44000	139300	
TA12-41SYKWB	TC12-41SYKWB	AlGaInP	● 590	75000	235600	
TA12-41CGKWB	TC12-41CGKWB	AlGaInP	● 570	26000	65300	
TA13-11SEKWB	TC13-11SEKWB	AlGaInP	● 601	75000	159800	<p>1.2 inch (30.5mm), 6x7, Black Face, White Dot</p>  <p style="text-align: right;">TX13</p>  <p style="text-align: center;">TA13-11</p> <p>PIN 8 9 10 11 12 13 C1 C2 C3 C4 C5 C6</p> <p>PIN 1 R1 2 R2 3 R3 4 R4 5 R5 6 R6 7 R7</p> <p style="text-align: center;">TC13-11</p> <p>PIN 8 9 10 11 12 13 C1 C2 C3 C4 C5 C6</p> <p>PIN 1 R1 2 R2 3 R3 4 R4 5 R5 6 R6 7 R7</p>
TA13-11SURKWB	TC13-11SURKWB	AlGaInP	● 630	44000	108700	
TA13-11SYKWB	TC13-11SYKWB	AlGaInP	● 590	44000	156300	
TA13-11CGKWB	TC13-11CGKWB	AlGaInP	● 570	18000	46300	

NOTES:

- All dimensions are in millimeters(inches).
- Tolerance is ±0.25mm(0.01") unless otherwise noted.

DOT MATRIX

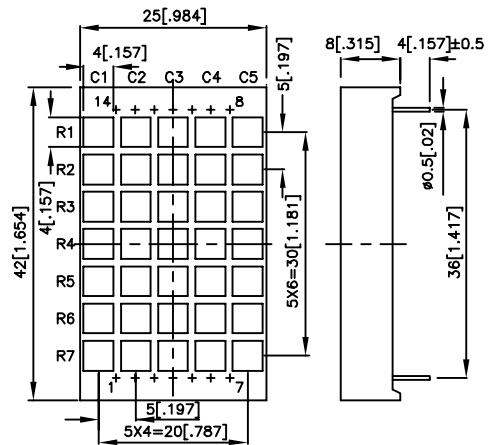
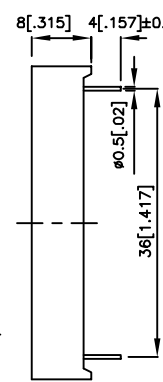
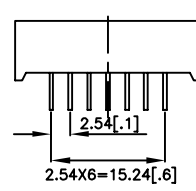
PART NUMBER		MATERIAL	λ D (nm)	Iv (ucd) @10mA		DIMENSION
COLUMN ANODE	COLUMN CATHODE			MIN.	TYP.	
TA16-31SEKWB	TC16-31SEKWB	AlGaInP	601	75000	169700	<p>1.338 inch (34mm), 5x7, Black Face, White Dot</p>  <p>TX16-31</p>    <p>TA16-31</p> <p>PIN 13 3 4,11 10 6 C1 C2 C3 C4 C5</p> <p>PIN 9 R1 14 R2 8 R3 12,5 R4 7 R5 1 R6 2 R7</p> <p>TC16-31</p> <p>PIN 13 3 4,11 10 6 C1 C2 C3 C4 C5</p> <p>PIN 9 R1 14 R2 8 R3 12,5 R4 7 R5 1 R6 2 R7</p>
TA16-31SURKWB	TC16-31SURKWB	AlGaInP	630	44000	100000	
TA16-31SYKWB	TC16-31SYKWB	AlGaInP	590	44000	168000	
TA16-31CGKWB	TC16-31CGKWB	AlGaInP	570	18000	42300	

NOTES:

1. All dimensions are in millimeters(inches).
2. Tolerance is ±0.25mm(0.01") unless otherwise noted.

DOT MATRIX

PART NUMBER		MATERIAL	λ D (nm)	Iv (ucd) @10mA		DIMENSION
COLUMN ANODE	COLUMN CATHODE			MIN.	TYP.	
TA07-11SEKWA	TC07-11SEKWA	AlGaInP	601	26000	116400	<p>0.7 inch (18mm), 5x7, Gray Face, White Dot</p> <p>TA07-11</p> <p>TC07-11</p> <p>TX07</p>
TA07-11SURKWA	TC07-11SURKWA	AlGaInP	630	18000	40600	
TA07-11SYKWA	TC07-11SYKWA	AlGaInP	590	18000	45100	
TA07-11CGKWA	TC07-11CGKWA	AlGaInP	570	12000	38100	
TA16-11SEKWA	TC16-11SEKWA	AlGaInP	601	26000	128500	<p>1.38 inch (35.2mm), 5x8, Gray Face, White Dot</p> <p>TA16-11</p> <p>TC16-11</p> <p>TX16</p>
TA16-11SURKWA	TC16-11SURKWA	AlGaInP	630	12000	58600	
TA16-11SYKWA	TC16-11SYKWA	AlGaInP	590	18000	115000	
TA16-11CGKWA	TC16-11CGKWA	AlGaInP	570	12000	54000	

NOTES:
 1. All dimensions are in millimeters (inches).
 2. Tolerance is ±0.25mm (0.01") unless otherwise noted.

DOT MATRIX

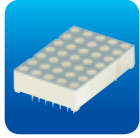
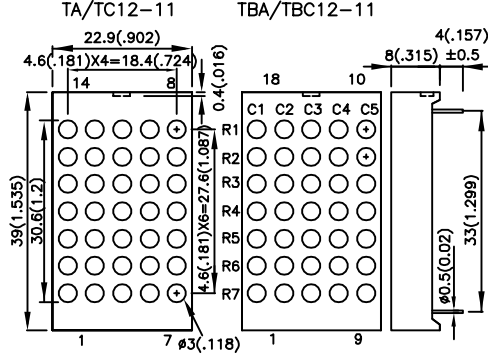
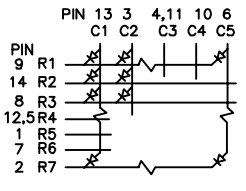
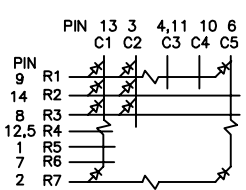
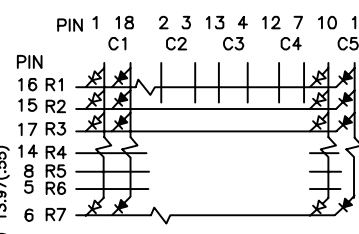
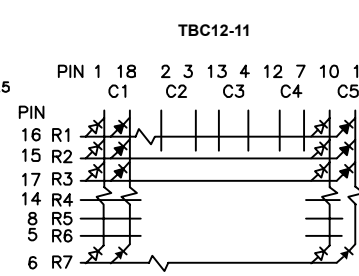
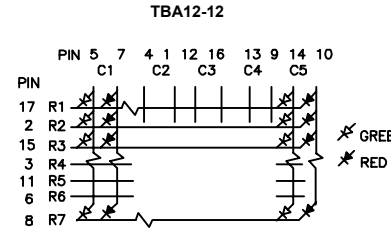
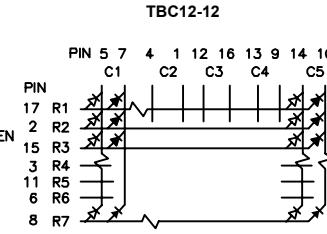
PART NUMBER		MATERIAL	λ D (nm)	Iv (ucd) @10mA		DIMENSION
COLUMN ANODE	COLUMN CATHODE			MIN.	TYP.	
TA12-11SEKWA	TC12-11SEKWA	AlGaInP	601	26000	127000	<p>1.2 inch (30mm), 5x7, Gray Face, White Dot</p>  <p>TA/TC12-11 TBA/TBC12-11</p>  <p>TA12-11</p>  <p>TC12-11</p>  <p>TBA12-11</p>  <p>TBC12-11</p>  <p>GREEN RED</p> <p>TBA12-12</p>  <p>TBC12-12</p>  <p>GREEN RED</p>
TA12-11SURKWA	TC12-11SURKWA	AlGaInP	630	18000	66800	
TA12-11SYKWA	TC12-11SYKWA	AlGaInP	590	18000	86500	
TA12-11CGKWA	TC12-11CGKWA	AlGaInP	570	18000	50200	
TBA12-11 SURKCGKWA	TBC12-11 SURKCGKWA	AlGaInP	630	18000	66800	
		AlGaInP	570	18000	50200	
TBA12-12 SURKCGKWA	TBC12-12 SURKCGKWA	AlGaInP	630	18000	66800	
		AlGaInP	570	18000	50200	

NOTES:
 1. All dimensions are in millimeters(inches).
 2. Tolerance is ±0.25mm(0.01") unless otherwise noted.

DOT MATRIX

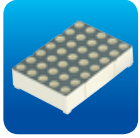
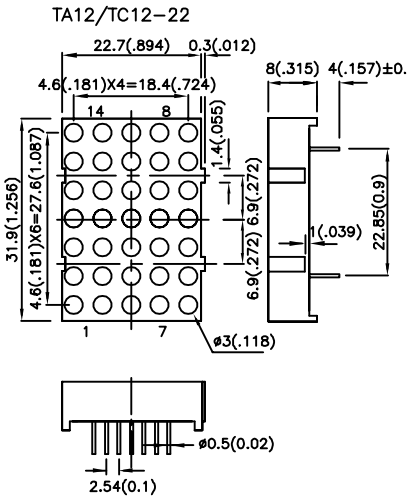
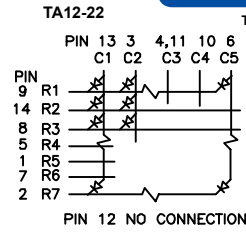
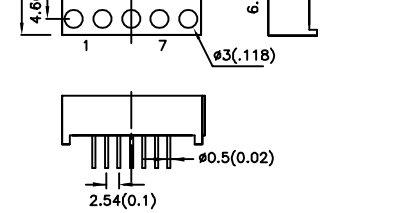
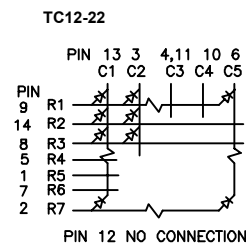
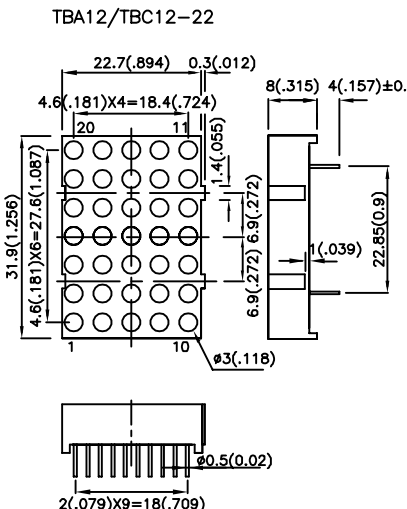
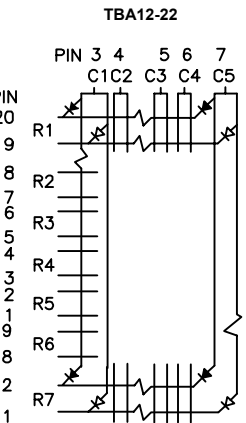
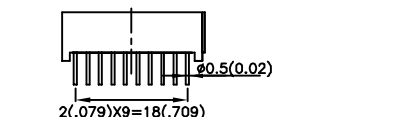
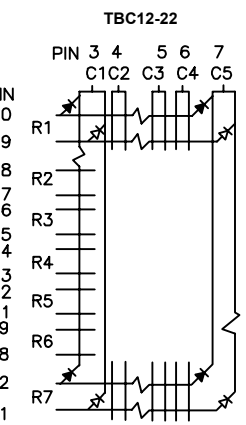
PART NUMBER		MATERIAL	λ D (nm)	Iv (ucd) @10mA		DIMENSION
COLUMN ANODE	COLUMN CATHODE			MIN.	TYP.	
TA12-22SEKWA	TC12-22SEKWA	AlGaInP	● 601	26000	127000	<p>1.2 inch (30mm), 5x7, Gray Face, White Dot</p>  <div style="display: flex; justify-content: space-around;"> <div style="text-align: center;"> <p>TA12/TC12-22</p>  </div> <div style="text-align: center;"> <p>TA12-22</p>  </div> </div> <div style="display: flex; justify-content: space-around;"> <div style="text-align: center;"> <p>TA12-22SURKWA</p>  </div> <div style="text-align: center;"> <p>TC12-22</p>  </div> </div> <div style="display: flex; justify-content: space-around;"> <div style="text-align: center;"> <p>TBA12/TBC12-22</p>  </div> <div style="text-align: center;"> <p>TBA12-22</p>  </div> </div> <div style="display: flex; justify-content: space-around;"> <div style="text-align: center;"> <p>TBA12-22 SURKCGKWA</p>  </div> <div style="text-align: center;"> <p>TBC12-22</p>  </div> </div> <div style="margin-top: 20px;"> <p>● GREEN ● RED 10 : N.C.</p> </div>
TA12-22SURKWA	TC12-22SURKWA	AlGaInP	● 630	18000	66800	
TA12-22SYKWA	TC12-22SYKWA	AlGaInP	● 590	18000	86500	
TA12-22CGKWA	TC12-22CGKWA	AlGaInP	● 570	18000	50200	
TBA12-22 SURKCGKWA	TBC12-22 SURKCGKWA	AlGaInP	● 630	18000	66800	
		AlGaInP	● 570	18000	50200	

NOTES:

1. All dimensions are in millimeters(inches).
2. Tolerance is ±0.25mm(0.01") unless otherwise noted.

DOT MATRIX

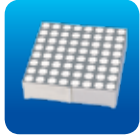
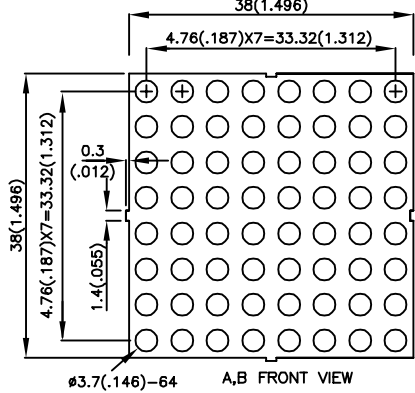
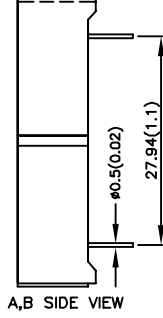
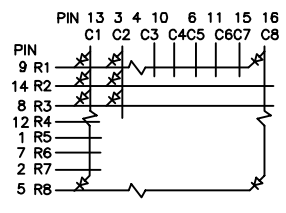
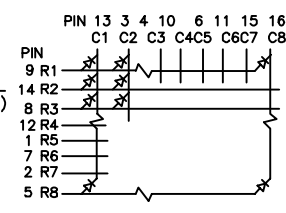
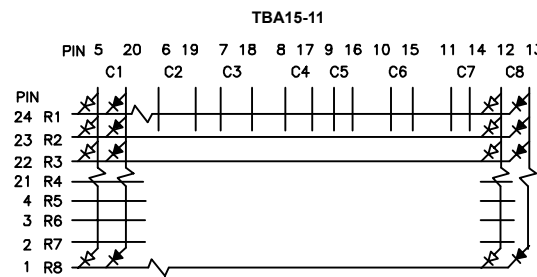
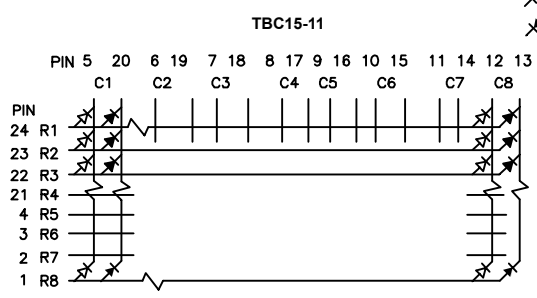
PART NUMBER		MATERIAL	λ D (nm)	Iv (ucd) @10mA		DIMENSION
COLUMN ANODE	COLUMN CATHODE			MIN.	TYP.	
TA15-11SEKWA	TC15-11SEKWA	AlGaInP	601	26000	137000	<p>1.5 inch (38mm), 8x8, Gray Face, White Dot</p> <p>A : TA/TC15-11 B : TBA/TBC15-11</p>  <p>TX15</p>  <p>38(1.496) 4.76(.187)X7=33.32(1.312) 38(1.496) 4.76(.187)X7=33.32(1.312) 0.3(.012) 1.4(.055) ø3.7(.146)-64 A,B FRONT VIEW</p>  <p>27.94(1.1) ø0.5(0.02) A,B SIDE VIEW</p> <p>TA15-11</p>  <p>PIN 13 3 4 10 6 11 15 16 C1 C2 C3 C4C5 C6C7 C8 PIN 9 R1 14 R2 8 R3 12 R4 1 R5 7 R6 2 R7 5 R8</p> <p>TC15-11</p>  <p>PIN 13 3 4 10 6 11 15 16 C1 C2 C3 C4C5 C6C7 C8 PIN 9 R1 14 R2 8 R3 12 R4 1 R5 7 R6 2 R7 5 R8</p> <p>TBA15-11</p>  <p>PIN 5 20 6 19 7 18 8 17 9 16 10 15 11 14 12 13 C1 C2 C3 C4 C5 C6 C7 C8 PIN 24 R1 23 R2 22 R3 21 R4 4 R5 3 R6 2 R7 1 R8</p> <p>TBC15-11</p>  <p>PIN 5 20 6 19 7 18 8 17 9 16 10 15 11 14 12 13 C1 C2 C3 C4 C5 C6 C7 C8 PIN 24 R1 23 R2 22 R3 21 R4 4 R5 3 R6 2 R7 1 R8</p> <p>GREEN RED</p>
TA15-11SURKWA	TC15-11SURKWA	AlGaInP	630	18000	68800	
TA15-11SYKWA	TC15-11SYKWA	AlGaInP	590	44000	162000	
TA15-11CGKWA	TC15-11CGKWA	AlGaInP	570	18000	54200	
TBA15-11 SURKCGKWA	TBC15-11 SURKCGKWA	AlGaInP	630	18000	68800	
		AlGaInP	570	18000	54200	

NOTES:
1. All dimensions are in millimeters(inches).
2. Tolerance is ±0.25mm(0.01") unless otherwise noted.

DOT MATRIX

PART NUMBER		MATERIAL	λ D (nm)	Iv (ucd) @10mA		DIMENSION
COLUMN ANODE	COLUMN CATHODE			MIN.	TYP.	
TA20-11SEKWA	TC20-11SEKWA	AlGaInP	● 601	26000	115000	<p>2.0 inch (50mm), 5x7, Gray Face, White Dot</p> <p>A,B,C,D FRONT VIEW</p> <p>A,B,C,D SIDE VIEW</p> <p> A: TA/TC20-11 B: TBA/TBC20-11 C: TBA/TBC20-12 D: TBA/TBC20-22 </p>
TA20-11SURKWA	TC20-11SURKWA	AlGaInP	● 630	18000	60000	
TA20-11SYKWA	TC20-11SYKWA	AlGaInP	● 590	18000	120000	
TA20-11CGKWA	TC20-11CGKWA	AlGaInP	● 570	18000	66200	
TBA20-11 SURKCGKWA	TBC20-11 SURKCGKWA	AlGaInP	● 630	18000	60000	
		AlGaInP	● 570	18000	66200	
TBA20-12 SURKCGKWA	TBC20-12 SURKCGKWA	AlGaInP	● 630	18000	60000	
		AlGaInP	● 570	18000	66200	
TBA20-22 SURKCGKWA	TBC20-22 SURKCGKWA	AlGaInP	● 630	18000	60000	
		AlGaInP	● 570	18000	66200	

NOTES:
 1. All dimensions are in millimeters(inches).
 2. Tolerance is ±0.25mm(0.01") unless otherwise noted.

DOT MATRIX

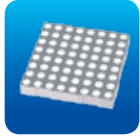
PART NUMBER		MATERIAL	λ D (nm)	Iv (ucd) @10mA		DIMENSION
COLUMN ANODE	COLUMN CATHODE			MIN.	TYP.	
TA23-11SEKWA	TC23-11SEKWA	AlGaInP	601	75000	183300	<p>2.3 inch (58mm), 8x8, Gray Face, White Dot</p> <p>A : TA/TC23-11 B : TBA/TBC23-12 C : TBA/TBC23-11</p>  <p>TX23</p> <p>A,B,C FRONT VIEW</p> <p>A,B,C SIDE VIEW</p> <p>A END VIEW</p> <p>B END VIEW</p> <p>C END VIEW</p> <p>TA23-11 TC23-11</p> <p>TBA23-12 TBC23-12</p> <p>TBA23-11 TBC23-11</p> <p>GREEN RED</p>
TA23-11SURKWA	TC23-11SURKWA	AlGaInP	630	26000	107300	
TA23-11SYKWA	TC23-11SYKWA	AlGaInP	590	26000	80500	
TA23-11CGKWA	TC23-11CGKWA	AlGaInP	570	18000	73700	
TBA23-11 SURKCGKWA	TBC23-11 SURKCGKWA	AlGaInP	630	26000	107300	
TBA23-11 SURKCGKWA	TBC23-11 SURKCGKWA	AlGaInP	570	18000	73700	
TBA23-12 SURKCGKWA	TBC23-12 SURKCGKWA	AlGaInP	630	26000	107300	
TBA23-12 SURKCGKWA	TBC23-12 SURKCGKWA	AlGaInP	570	18000	73700	

NOTES:
1. All dimensions are in millimeters(inches).
2. Tolerance is ±0.25mm(0.01") unless otherwise noted.

DOT MATRIX

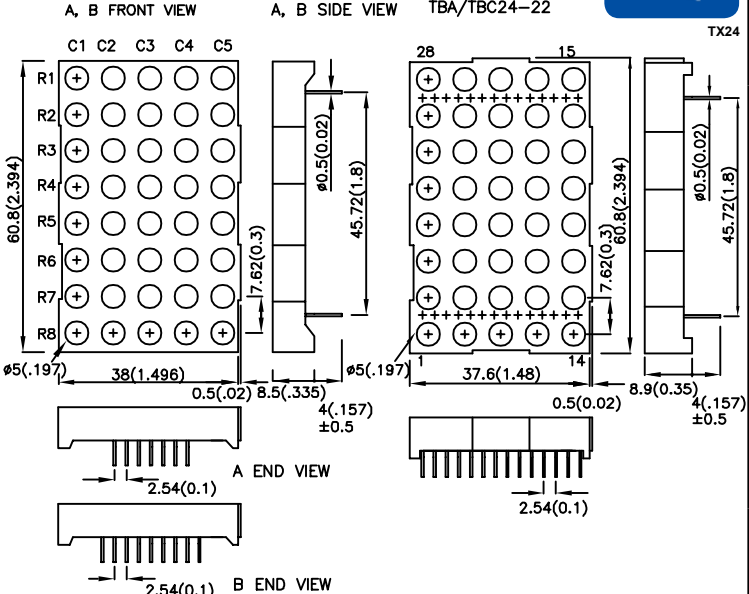
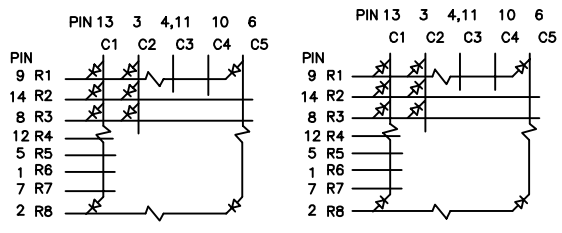
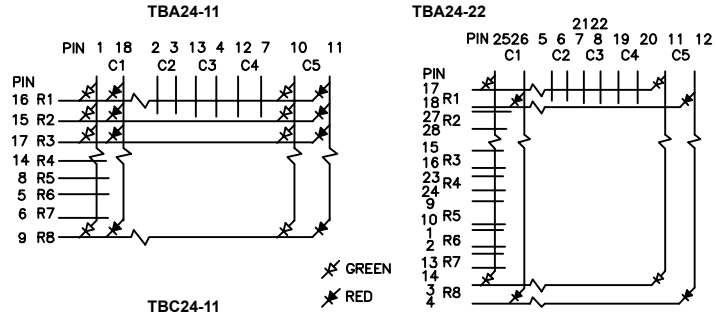
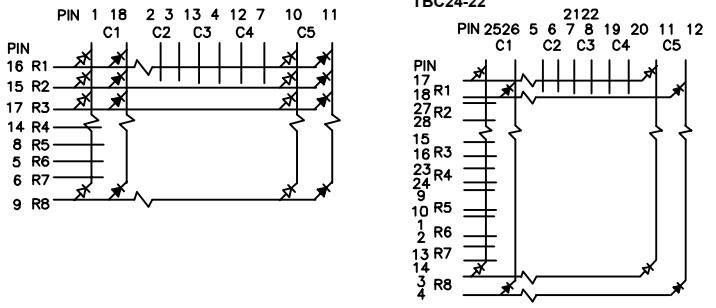
PART NUMBER		MATERIAL	λ D (nm)	Iv (ucd) @10mA		DIMENSION
COLUMN ANODE	COLUMN CATHODE			MIN.	TYP.	
TA24-11SEKWA	TC24-11SEKWA	AlGaInP	601	44000	250700	<p>2.4 inch (60.8mm), 5x8, Gray Face, White Dot</p> <p>A: TA/TC24-11 B: TBA/TBC24-11</p>  <p>A, B FRONT VIEW A, B SIDE VIEW TBA/TBC24-22</p>  <p>TA24-11 TC24-11</p>  <p>TBA24-11 TBA24-22</p>  <p>TBC24-11 TBC24-22</p> 
TA24-11SURKWA	TC24-11SURKWA	AlGaInP	630	44000	120000	
TA24-11SYKWA	TC24-11SYKWA	AlGaInP	590	44000	230400	
TA24-11CGKWA	TC24-11CGKWA	AlGaInP	570	26000	61600	
TBA24-11 SURKCGKWA	TBC24-11 SURKCGKWA	AlGaInP	630	44000	120000	
TBA24-11 SURKCGKWA	TBC24-11 SURKCGKWA	AlGaInP	570	26000	61600	
TBA24-22 SURKCGKWA	TBC24-22 SURKCGKWA	AlGaInP	630	44000	120000	
TBA24-22 SURKCGKWA	TBC24-22 SURKCGKWA	AlGaInP	570	26000	61600	

NOTES:

1. All dimensions are in millimeters(inches).
2. Tolerance is ±0.25mm(0.01") unless otherwise noted.

DOT MATRIX

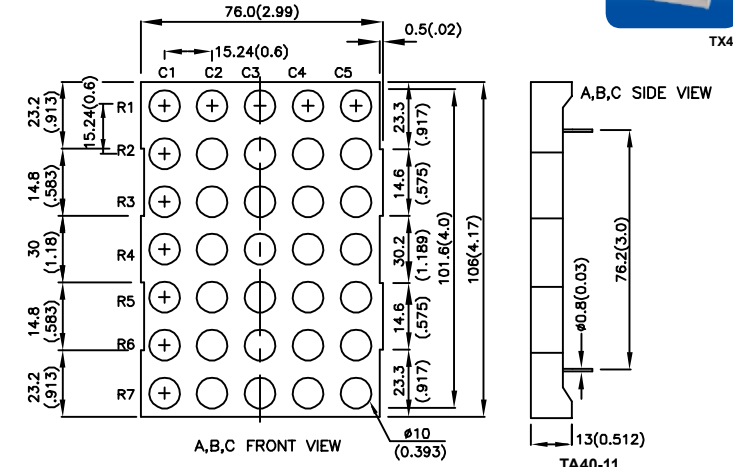
PART NUMBER		MATERIAL	λ D (nm)	Iv (ucd) @10mA		DIMENSION
COLUMN ANODE	COLUMN CATHODE			MIN.	TYP.	
TA40-11SEKWA	TC40-11SEKWA	AlGaInP	601	75000	306000	<p>4.0 inch (100mm), 5x7, Gray Face, White Dot</p> <p>A : TA/TC40-11 B : TBA/TBC40-11 C : TBA/TBC40-12</p>  <p>A,B,C FRONT VIEW</p> <p>A,B,C SIDE VIEW</p> <p>A END VIEW</p> <p>B END VIEW</p> <p>C END VIEW</p> <p>TBA40-11</p> <p>TBC40-11</p> <p>TBA40-12</p> <p>TBC40-12</p> <p>✱ FOR 2 RED CHIPS ✱ FOR 2 GREEN CHIPS</p>
TA40-11SURKWA	TC40-11SURKWA	AlGaInP	630	26000	97500	
TA40-11SYKWA	TC40-11SYKWA	AlGaInP	590	75000	302000	
TA40-11CGKWA	TC40-11CGKWA	AlGaInP	570	26000	90000	
TBA40-11 SURKCGKWA	TBC40-11 SURKCGKWA	AlGaInP	630	26000	97500	
		AlGaInP	570	26000	90000	
TBA40-12 SURKCGKWA	TBC40-12 SURKCGKWA	AlGaInP	630	26000	97500	
		AlGaInP	570	26000	90000	

NOTES:
1. All dimensions are in millimeters(inches).
2. Tolerance is ±0.25mm(0.01") unless otherwise noted.

Kingbright

Optoelectronic Components



LED LIGHT BAR

73

Bar Graph Array
Light Bar

73

74

BAR GRAPH ARRAY

PART NUMBER	EMITTING COLOR + λ, D (nm) + MATERIAL	I _v (ucd) @10mA		DESCRIPTION	DIMENSION
		MIN.	TYP.		
DC-10SEKWA	Super Bright Orange ● 601 AlGaInP	44000	114000	10 Segments Bar graph-Display Gray Face White Segment	
DC-10SURKWA	Hyper Red ● 630 AlGaInP	8000	40000		
DC-10SYKWA	Super Bright Yellow ● 590 AlGaInP	26000	104000		
DC-10CGKWA	Green ● 570 AlGaInP	8000	30900		
DC-20/20SEKWA	Super Bright Orange ● 601 AlGaInP	44000	114000	20 Segments Bar graph-Display Gray Face White Segment	
DC-20/20SURKWA	Hyper Red ● 630 AlGaInP	8000	40000		
DC-20/20SYKWA	Super Bright Yellow ● 590 AlGaInP	26000	104000		
DC-20/20CGKWA	Green ● 570 AlGaInP	8000	30900		
DD-12SEKWB	Super Bright Orange ● 601 AlGaInP	44000	184300	12 Segments Bar graph-Display Black Face White Segment	
DD-12SURKWB	Hyper Red ● 630 AlGaInP	26000	84300		
DD-12SYKWB	Super Bright Yellow ● 590 AlGaInP	44000	128300		
DD-12CGKWB	Green ● 570 AlGaInP	18000	45000		

NOTES:
 1. All dimensions are in millimeters(inches).
 2. Tolerance is ±0.25mm(0.01") unless otherwise noted.

LIGHT BAR

PART NUMBER	MATERIAL	λ_D (nm)	LENS TYPE	Iv (mcd) @20mA		VIEWING ANGLE	DIMENSION
				MIN.	TYP.		
L-1043SEDTK	AlGaInP	601	orange diffused	50	180	100°	3.65mm x 6.15mm
L-1043SURDTK	AlGaInP	630	red diffused	70	350	100°	
L-1043SYDTK	AlGaInP	590	yellow diffused	18	55	100°	
L-1043CGDTK	AlGaInP	570	green diffused	7	20	100°	
L-835/2SEDTK	AlGaInP	601	orange diffused	80	300	120°	5mm x 10mm
L-835/2SURDTK	AlGaInP	630	red diffused	36	80	120°	
L-835/2SYDTK	AlGaInP	590	yellow diffused	10	25	120°	
L-835/2CGDTK	AlGaInP	570	green diffused	7	30	120°	

PART NUMBER	MATERIAL	λ_D (nm)	LENS TYPE	Iv (mcd) @20mA		DIMENSION
				MIN.	TYP.	
DE/2SEKD	AlGaInP	601	orange diffused	380	660	7.5mm x 14mm
DE/2SURKD	AlGaInP	630	red diffused	280	550	
DE/2SYKD	AlGaInP	590	yellow diffused	380	600	
DE/2CGKD	AlGaInP	570	green diffused	110	200	
DF-3SEKD	AlGaInP	601	orange diffused	480	800	6.8mm x 19.9mm
DF-3SURKD	AlGaInP	630	red diffused	160	500	
DF-3SYKD	AlGaInP	590	yellow diffused	360	935	
DF-3CGKD	AlGaInP	570	green diffused	70	235	
DE/4SEKD	AlGaInP	601	orange diffused	650	1550	15mm x 15mm
DE/4SURKD	AlGaInP	630	red diffused	380	730	
DE/4SYKD	AlGaInP	590	yellow diffused	480	955	
DE/4CGKD	AlGaInP	570	green diffused	110	230	

NOTES:
 1. All dimensions are in millimeters(inches).
 2. Tolerance is $\pm 0.25\text{mm}(0.01\text{'})$ unless otherwise noted.

LIGHT BAR

PART NUMBER	EMITTING COLOR + MATERIAL	λD (nm)	LENS TYPE	Iv (mcd) @20mA		DIMENSION
				MIN.	TYP.	
KB-2300SEKW	Super Bright Orange AlGaInP	601	white diffused	280	470	<p>8.89mm x 3.81mm Size of Light Emitting Areas</p> <p>KB-2300SEKW</p>
KB-A100SURKW	Hyper Red AlGaInP	630	white diffused	50	175	
KB-2400SYKW	Super Bright Yellow AlGaInP	590	white diffused	18	80	
KB-2500CGKD	Green AlGaInP	570	green diffused	18	60	
KB-2350SEKW	Super Bright Orange AlGaInP	601	white diffused	180	400	<p>19.05mm x 3.81mm Size of Light Emitting Areas</p> <p>KB-2350SEKW</p>
KB-B100SURKW	Hyper Red AlGaInP	630	white diffused	70	305	
KB-2450SYKW	Super Bright Yellow AlGaInP	590	white diffused	180	430	
KB-2550CGKD	Green AlGaInP	570	green diffused	50	185	
KB-2655SEKW	Super Bright Orange AlGaInP	601	white diffused	280	600	<p>8.89mm x 8.89mm Size of Light Emitting Areas</p> <p>KB-2655SEKW</p>
KB-C100SURKW	Hyper Red AlGaInP	630	white diffused	280	525	
KB-2755SYKW	Super Bright Yellow AlGaInP	590	white diffused	70	260	
KB-2855CGKD	Green AlGaInP	570	green diffused	110	270	
KB-2600SEKW	Super Bright Orange AlGaInP	601	white diffused	280	465	<p>8.89mm x 3.81mm Size of Light Emitting Areas</p> <p>KB-2600SEKW</p>
KB-D100SURKW	Hyper Red AlGaInP	630	white diffused	110	265	
KB-2700SYKW	Super Bright Yellow AlGaInP	590	white diffused	110	315	
KB-2800CGKD	Green AlGaInP	570	green diffused	36	80	

NOTES:
 1. All dimensions are in millimeters (inches).
 2. Tolerance is ±0.25mm (0.01") unless otherwise noted.

LIGHT BAR

PART NUMBER	EMITTING COLOR + MATERIAL	λ_D (nm)	LENS TYPE	Iv (mcd) @20mA		DIMENSION
				MIN.	TYP.	
KB-2620SEKW	Super Bright Orange AlGaInP	601	white diffused	180	425	<p>8.89mm x 3.81mm Size of Light Emitting Areas</p> <p>KB-2620SEKW</p>
KB-E100SURKW	Hyper Red AlGaInP	630	white diffused	70	210	
KB-2720SYKW	Super Bright Yellow AlGaInP	590	white diffused	110	375	
KB-2820CGKD	Green AlGaInP	570	green diffused	18	60	
KB-2635SEKW	Super Bright Orange AlGaInP	601	white diffused	180	355	<p>3.81mm x 19.05mm Size of Light Emitting Areas</p> <p>KB-2635SEKW</p>
KB-F100SURKW	Hyper Red AlGaInP	630	white diffused	110	205	
KB-2735SYKW	Super Bright Yellow AlGaInP	590	white diffused	110	280	
KB-2835CGKD	Green AlGaInP	570	green diffused	36	70	
KB-2670SEKW	Super Bright Orange AlGaInP	601	white diffused	280	415	<p>8.89mm x 8.89mm Size of Light Emitting Areas</p> <p>KB-2670SEKW</p>
KB-G100SURKW	Hyper Red AlGaInP	630	white diffused	110	205	
KB-2770SYKW	Super Bright Yellow AlGaInP	590	white diffused	110	315	
KB-2870CGKD	Green AlGaInP	570	green diffused	36	75	
KB-2685SEKW	Super Bright Orange AlGaInP	601	white diffused	280	450	<p>8.89mm x 19.05mm Size of Light Emitting Areas</p> <p>KB-2685SEKW</p>
KB-H100SURKW	Hyper Red AlGaInP	630	white diffused	70	315	
KB-2785SYKW	Super Bright Yellow AlGaInP	590	white diffused	180	410	
KB-2885CGKD	Green AlGaInP	570	green diffused	70	205	

NOTES:

1. All dimensions are in millimeters(inches).
2. Tolerance is $\pm 0.25\text{mm}(0.01\text{'})$ unless otherwise noted.

Kingbright

Optoelectronic Components



Circuit Board Indicator





77



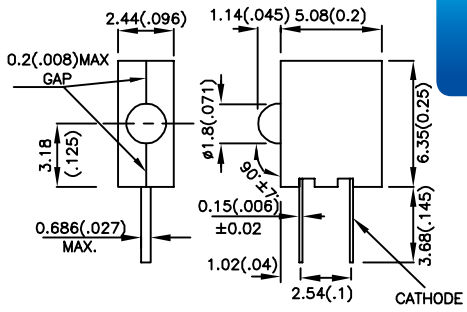

Single-Level CBI	77
Bi-Level CBI	80
Tri-Level CBI	83
Quad-Level CBI	84
With Spacer	84
SMD CBI	85

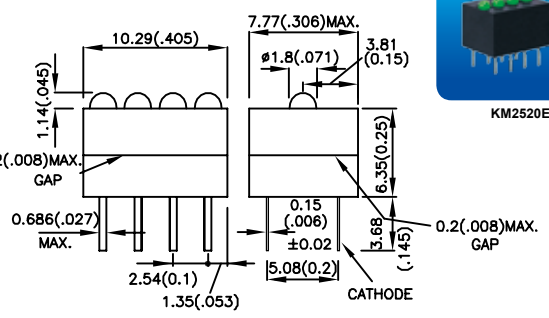
LED Clips and Mounts

86

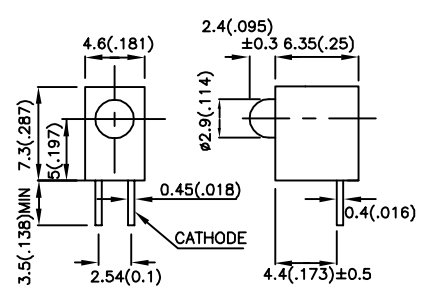
SINGLE-LEVEL CBI

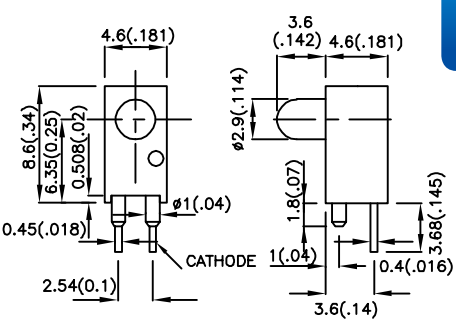
PART NUMBER	MATERIAL	λ_D (nm)	LENS TYPE	Iv (mcd) @20mA *V=5V		VIEWING ANGLE 2 θ 1/2	DIMENSION
				MIN.	TYP.		
KM2520EH/1ID	GaAsP/GaP	625	red diffused	7	30	40°	Subminiature Solid State Lamps  
KM2520EH/1ID-5V	GaAsP/GaP	625	red diffused	*1.8	*8	40°	
KM2520EH/1YD	GaAsP/GaP	588	yellow diffused	2.6	10	40°	
KM2520EH/1YD-5V	GaAsP/GaP	588	yellow diffused	*1	*3	40°	
KM2520EH/1SGD	GaP	568	green diffused	2.6	10	40°	
KM2520EH/1SGD-5V	GaP	568	green diffused	*1.8	*8	40°	
KM2520EG/4ID	GaAsP/GaP	625	red diffused	7	30	40°	Subminiature Solid State Lamps  
KM2520EG/4ID-5V	GaAsP/GaP	625	red diffused	*1.8	*8	40°	
KM2520EG/4YD	GaAsP/GaP	588	yellow diffused	2.6	10	40°	
KM2520EG/4YD-5V	GaAsP/GaP	588	yellow diffused	*1	*3	40°	
KM2520EG/4SGD	GaP	568	green diffused	2.6	10	40°	
KM2520EG/4SGD-5V	GaP	568	green diffused	*1.8	*8	40°	

PART NUMBER	MATERIAL	λ_D (nm)	LENS TYPE	Iv (mcd) @10mA *20mA		VIEWING ANGLE 2 θ 1/2	DIMENSION
				MIN.	TYP.		
L-710A8CB/1ID	GaAsP/GaP	625	red diffused	12	25	40°	T-1 (3mm) Right Angle  
L-710A8CB/1SRD	GaAlAs	640	red diffused	*110	*280	40°	
L-710A8CB/1YD	GaAsP/GaP	588	yellow diffused	5	12	40°	
L-710A8CB/1GD	GaP	568	green diffused	8	20	40°	
L-710A8RS/1ID	GaAsP/GaP	625	red diffused	12	25	40°	T-1 (3mm) Right Angle  
L-710A8RS/1SRD	GaAlAs	640	red diffused	*110	*280	40°	
L-710A8RS/1YD	GaAsP/GaP	588	yellow diffused	5	12	40°	
L-710A8RS/1GD	GaP	568	green diffused	8	20	40°	

NOTES:

1. All dimensions are in millimeters(inches).
2. Tolerance is $\pm 0.25\text{mm}(0.01")$ unless otherwise noted.

SINGLE-LEVEL CBI

PART NUMBER	MATERIAL	λD (nm)	LENS TYPE	Iv (mcd) @10mA *20mA		VIEWING ANGLE	DIMENSION
				MIN.	TYP.		
L-7104EW/1ID	GaAsP/GaP	625	red diffused	8	20	40°	T-1 (3mm) Right Angle
L-7104EW/1SRD	GaAlAs	640	red diffused	*110	*300	40°	
L-7104EW/1YD	GaAsP/GaP	588	yellow diffused	5	15	40°	
L-7104EW/1GD	GaP	568	green diffused	8	20	40°	
L-7104ZH/1ID	GaAsP/GaP	625	red diffused	8	20	40°	T-1 (3mm) Right Angle
L-7104ZH/1SRD	GaAlAs	640	red diffused	*110	*300	40°	
L-7104ZH/1YD	GaAsP/GaP	588	yellow diffused	5	15	40°	
L-7104ZH/1GD	GaP	568	green diffused	8	20	40°	
L-130WDT/1EGW	GaAsP/GaP	625	white diffused	*7	*30	60°	T-1 (3mm) Right Angle
	GaP	568		*7	*25		
L-130WDT/1EYW	GaAsP/GaP	625	white diffused	*7	*30	60°	
	GaAsP/GaP	588		*7	*20		
L-130WDT/1GYW	GaP	568	white diffused	*7	*25	60°	
	GaAsP/GaP	588		*7	*20		
L-42WUM/1EGWT	GaAsP/GaP	625	white diffused	*4	*13	100°	T-1 (3mm) Right Angle
	GaP	568		*4	*13		
L-42WUM/1EYWT	GaAsP/GaP	625	white diffused	*4	*13	100°	
	GaAsP/GaP	588		*2.6	*6		
L-42WUM/1GYWT	GaP	568	white diffused	*4	*13	100°	
	GaAsP/GaP	588		*2.6	*6		

NOTES:
 1. All dimensions are in millimeters(inches).
 2. Tolerance is ±0.25mm(0.01") unless otherwise noted.

SINGLE-LEVEL CBI

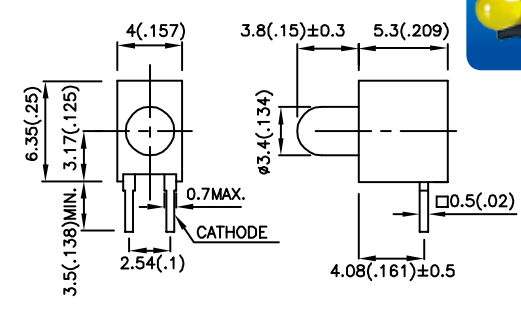
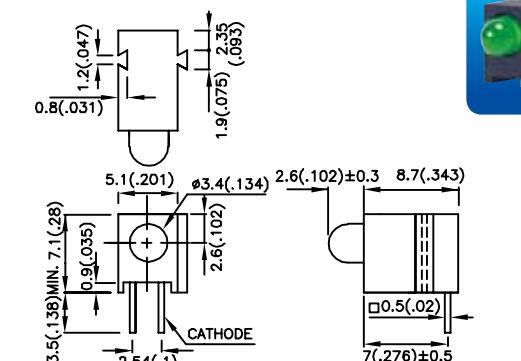
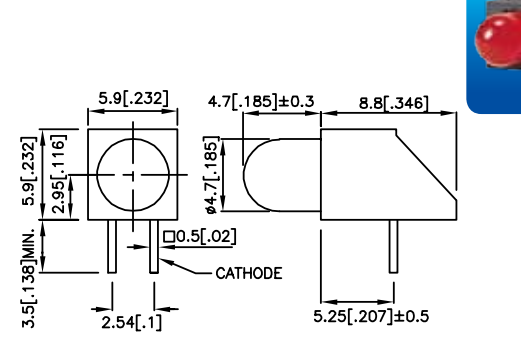
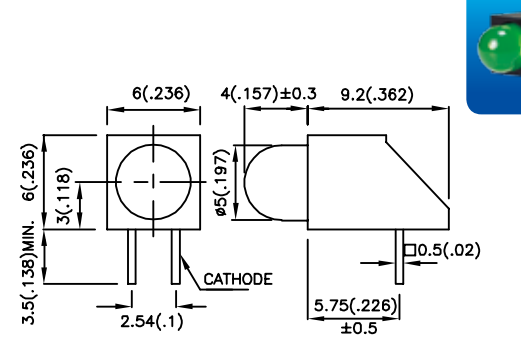
PART NUMBER	MATERIAL	λ_D (nm)	LENS TYPE	Iv (mcd) @10mA *20mA		VIEWING ANGLE 2 θ 1/2	DIMENSION
				MIN.	TYP.		
L-1384AD/1ID	GaAsP/GaP	625	red diffused	12	20	60°	3.4mm Right Angle  Detailed technical drawing showing front and side views of a 3.4mm right angle LED indicator. Dimensions include: 4(.157) lens diameter, 6.35(.25) total height, 3.17(.125) lens height, 3.5(.138) MIN. mounting hole diameter, 2.54(.1) mounting hole offset, 0.7 MAX. cathode lead length, 3.8(.15)±0.3 and 5.3(.209) body width, 3.4(.134) body diameter, 4.08(.161)±0.5 body length, and 0.5(.02) lead width.
L-1384AD/1SRD	GaAlAs	640	red diffused	*70	*200	60°	
L-1384AD/1YD	GaAsP/GaP	588	yellow diffused	8	15	60°	
L-1384AD/1GD	GaP	568	green diffused	8	15	60°	
L-1384AL/1ID	GaAsP/GaP	625	red diffused	12	20	60°	3.4mm Right Angle  Detailed technical drawing showing front and side views of a 3.4mm right angle LED indicator. Dimensions include: 1.2(.047) lens diameter, 0.8(.031) lens height, 1.9(.075) body diameter, 5.1(.201) lens diameter, 3.4(.134) body diameter, 2.6(.102)±0.3 body length, 8.7(.343) total length, 7.1(.28) mounting hole diameter, 0.9(.035) mounting hole offset, 3.5(.138) MIN. mounting hole diameter, 2.54(.1) mounting hole offset, 2.6(.102) cathode lead length, and 7(.276)±0.5 body length.
L-1384AL/1SRD	GaAlAs	640	red diffused	*70	*200	60°	
L-1384AL/1YD	GaAsP/GaP	588	yellow diffused	8	15	60°	
L-1384AL/1GD	GaP	568	green diffused	8	15	60°	
L-1533BQ/1ID	GaAsP/GaP	625	red diffused	8	30	60°	4.7mm Right Angle  Detailed technical drawing showing front and side views of a 4.7mm right angle LED indicator. Dimensions include: 5.9[.232] lens diameter, 2.95[.116] lens height, 4.7[.185]±0.3 body diameter, 8.8[.346] total length, 3.5[.138] MIN. mounting hole diameter, 2.54[.1] mounting hole offset, 0.5[.02] lead width, 4.7[.185] body diameter, and 5.25[.207]±0.5 body length.
L-1533BQ/1SRD	GaAlAs	640	red diffused	*110	*400	60°	
L-1533BQ/1YD	GaAsP/GaP	588	yellow diffused	5	18	60°	
L-1533BQ/1GD	GaP	568	green diffused	5	20	60°	
L-1503CB/1ID	GaAsP/GaP	625	red diffused	8	30	60°	T-1 3/4 (5mm) Right Angle  Detailed technical drawing showing front and side views of a T-1 3/4 (5mm) right angle LED indicator. Dimensions include: 6(.236) lens diameter, 3(.118) lens height, 4(.157)±0.3 body diameter, 9.2(.362) total length, 3.5(.138) MIN. mounting hole diameter, 2.54(.1) mounting hole offset, 0.5(.02) lead width, 5(.197) body diameter, and 5.75(.226)±0.5 body length.
L-1503CB/1SRD	GaAlAs	640	red diffused	*380	*700	60°	
L-1503CB/1YD	GaAsP/GaP	588	yellow diffused	5	20	60°	
L-1503CB/1GD	GaP	568	green diffused	5	20	60°	

NOTES:

1. All dimensions are in millimeters(inches).
2. Tolerance is ±0.25mm(0.01") unless otherwise noted.

SINGLE-LEVEL CBI

PART NUMBER	MATERIAL	λ_D (nm)	LENS TYPE	Iv (mcd) @20mA		VIEWING ANGLE	DIMENSION
				MIN.	TYP.		
L-150A9VS/1EGW	GaAsP/GaP	625	white diffused	18	50	30°	<p>T-1 3/4 (5mm) Right Angle</p>
	GaP	568		10	45		
L-150A9VS/1EYW	GaAsP/GaP	625	white diffused	18	50	30°	
	GaAsP/GaP	588		7	30		
L-150A9VS/1GYW	GaP	568	white diffused	10	45	30°	
	GaAsP/GaP	588		7	30		
L-59BL/1EGW	GaAsP/GaP	625	white diffused	18	60	60°	<p>T-1 3/4 (5mm) Right Angle</p>
	GaP	568		18	50		
L-59BL/1EYW	GaAsP/GaP	625	white diffused	18	60	60°	
	GaAsP/GaP	588		18	40		
L-59BL/1GYW	GaP	568	white diffused	18	50	60°	
	GaAsP/GaP	588		18	40		
L-59CB/1EGW	GaAsP/GaP	625	white diffused	18	60	60°	<p>T-1 3/4 (5mm) Right Angle</p>
	GaP	568		18	50		
L-59CB/1EYW	GaAsP/GaP	625	white diffused	18	60	60°	
	GaAsP/GaP	588		18	40		
L-59CB/1GYW	GaP	568	white diffused	18	50	60°	
	GaAsP/GaP	588		18	40		



BI-LEVEL CBI

PART NUMBER	MATERIAL	λ_D (nm)	LENS TYPE	Iv (mcd) @10mA *20mA		VIEWING ANGLE	DIMENSION
				MIN.	TYP.		
L-4060VH/2ID	GaAsP/GaP	625	red diffused	8	15	70°	<p>1.8mm Bi-Level</p>
L-4060VH/2SRD	GaAlAs	640	red diffused	*70	*200	70°	
L-4060VH/2YD	GaAsP/GaP	588	yellow diffused	1.8	5	70°	
L-4060VH/2GD	GaP	568	green diffused	5	10	70°	

NOTES:

1. All dimensions are in millimeters(inches).
2. Tolerance is ±0.25mm(0.01") unless otherwise noted.

BI-LEVEL CBI

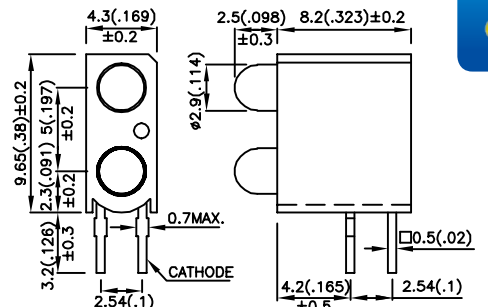
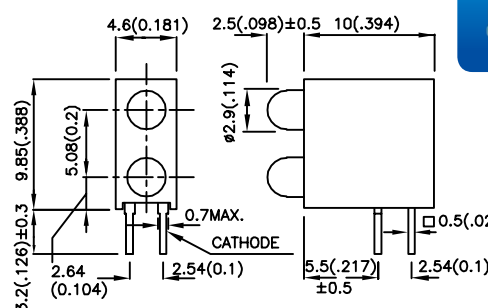
PART NUMBER	MATERIAL	λ_D (nm)	LENS TYPE	Iv (mcd) @10mA *20mA		VIEWING ANGLE 2 θ 1/2	DIMENSION
				MIN.	TYP.		
L-7104EB/2ID	GaAsP/GaP	625	red diffused	8	20	40°	T-1 (3mm) Bi-Level  L-7104EB/2 
L-7104EB/2SRD	GaAlAs	640	red diffused	*110	*300	40°	
L-7104EB/2YD	GaAsP/GaP	588	yellow diffused	5	15	40°	
L-7104EB/2GD	GaP	568	green diffused	8	20	40°	
L-7104FG/2ID	GaAsP/GaP	625	red diffused	8	20	40°	T-1 (3mm) Bi-Level  L-7104FG/2 
L-7104FG/2SRD	GaAlAs	640	red diffused	*110	*300	40°	
L-7104FG/2YD	GaAsP/GaP	588	yellow diffused	5	15	40°	
L-7104FG/2GD	GaP	568	green diffused	8	20	40°	
L-7104FO/2ID	GaAsP/GaP	625	red diffused	8	20	40°	T-1 (3mm) Bi-Level  L-7104FO/2 
L-7104FO/2SRD	GaAlAs	640	red diffused	*110	*300	40°	
L-7104FO/2YD	GaAsP/GaP	588	yellow diffused	5	15	40°	
L-7104FO/2GD	GaP	568	green diffused	8	20	40°	
L-7104GE/2ID	GaAsP/GaP	625	red diffused	8	20	40°	T-1 (3mm) Bi-Level  L-7104GE/2 
L-7104GE/2SRD	GaAlAs	640	red diffused	*110	*300	40°	
L-7104GE/2YD	GaAsP/GaP	588	yellow diffused	5	15	40°	
L-7104GE/2GD	GaP	568	green diffused	8	20	40°	

NOTES:

1. All dimensions are in millimeters (inches).
2. Tolerance is $\pm 0.25\text{mm}$ (0.01") unless otherwise noted.

BI-LEVEL CBI

PART NUMBER	MATERIAL	λ_D (nm)	LENS TYPE	Iv (mcd) @10mA *20mA		VIEWING ANGLE	DIMENSION
				MIN.	TYP.		
L-7104GO/2ID	GaAsP/GaP	625	red diffused	8	20	40°	<p>T-1 (3mm) Bi-Level</p>
L-7104GO/2SRD	GaAlAs	640	red diffused	*110	*300	40°	
L-7104GO/2YD	GaAsP/GaP	588	yellow diffused	5	15	40°	
L-7104GO/2GD	GaP	568	green diffused	8	20	40°	
L-7104MD/2ID	GaAsP/GaP	625	red diffused	8	20	40°	<p>T-1 (3mm) Bi-Level</p>
L-7104MD/2SRD	GaAlAs	640	red diffused	*110	*300	40°	
L-7104MD/2YD	GaAsP/GaP	588	yellow diffused	5	15	40°	
L-7104MD/2GD	GaP	568	green diffused	8	20	40°	
L-130WCP/2EGW	GaAsP/GaP	625	white diffused	*7	*30	60°	<p>T-1 (3mm) Bi-Level</p>
	GaP	568		*7	*25		
L-130WCP/2EYW	GaAsP/GaP	625	white diffused	*7	*30	60°	
	GaAsP/GaP	588		*7	*20		
L-130WCP/2GYW	GaP	568	white diffused	*7	*25	60°	
	GaAsP/GaP	588		*7	*20		
L-73EB/2IDA	GaAsP/GaP	625	red diffused	8	30	60°	<p>4.8mm Bi-Level</p>
L-73EB/2SRDA	GaAlAs	640	red diffused	*110	*300	60°	
L-73EB/2YDA	GaAsP/GaP	588	yellow diffused	5	20	60°	
L-73EB/2GDA	GaP	568	green diffused	8	20	60°	

NOTES:

1. All dimensions are in millimeters(inches).
2. Tolerance is $\pm 0.25\text{mm}(0.01")$ unless otherwise noted.

BI-LEVEL CBI

PART NUMBER	MATERIAL	λ_D (nm)	LENS TYPE	Iv (mcd) @10mA *20mA		VIEWING ANGLE 2 θ 1/2	DIMENSION
				MIN.	TYP.		
L-1503EB/2ID	GaAsP/GaP	625	red diffused	8	30	60°	T-1 3/4 (5mm) Bi-Level
L-1503EB/2SRD	GaAlAs	640	red diffused	*380	*700	60°	
L-1503EB/2YD	GaAsP/GaP	588	yellow diffused	5	20	60°	
L-1503EB/2GD	GaP	568	green diffused	5	20	60°	

TRI-LEVEL CBI

PART NUMBER	MATERIAL	λ_D (nm)	LENS TYPE	Iv (mcd) @10mA *20mA		VIEWING ANGLE 2 θ 1/2	DIMENSION
				MIN.	TYP.		
L-4060XH/3ID	GaAsP/GaP	625	red diffused	8	15	70°	1.8mm Tri-Level
L-4060XH/3SRD	GaAlAs	640	red diffused	*70	*200	70°	
L-4060XH/3YD	GaAsP/GaP	588	yellow diffused	1.8	5	70°	
L-4060XH/3GD	GaP	568	green diffused	5	10	70°	
L-7104SA/3ID	GaAsP/GaP	625	red diffused	8	20	40°	T-1 (3mm) Tri-Level
L-7104SA/3SRD	GaAlAs	640	red diffused	*110	*300	40°	
L-7104SA/3YD	GaAsP/GaP	588	yellow diffused	5	15	40°	
L-7104SA/3GD	GaP	568	green diffused	8	20	40°	

NOTES:

1. All dimensions are in millimeters(inches).
2. Tolerance is ±0.25mm(0.01") unless otherwise noted.

QUAD-LEVEL CBI



PART NUMBER	MATERIAL	λ_D (nm)	LENS TYPE	Iv (mcd) @10mA *20mA		VIEWING ANGLE	DIMENSION
				MIN.	TYP.		
L-7104SB/4ID	GaAsP/GaP	625	red diffused	8	20	40°	T-1 (3mm) Quad-Level
L-7104SB/4SRD	GaAlAs	640	red diffused	*110	*300	40°	
L-7104SB/4YD	GaAsP/GaP	588	yellow diffused	5	15	40°	
L-7104SB/4GD	GaP	568	green diffused	8	20	40°	
L-914CK/4IDT	GaAsP/GaP	625	red diffused	1.8	8	100°	2mm x 3mm Quad-Level
L-914CK/4YDT	GaAsP/GaP	588	yellow diffused	1	4	100°	
L-914CK/4GDT	GaP	568	green diffused	1.8	6	100°	

WITH SPACER

PART NUMBER	MATERIAL	λ_D (nm)	LENS TYPE	Iv (mcd) @10mA *20mA		VIEWING ANGLE	DIMENSION
				MIN.	TYP.		
L-7113BR-5.08/ID L-7113BR-6.35/ID L-7113BR-9.52/ID L-7113BR-17.8/ID L-7113BR-23.5/ID	GaAsP/GaP	625	red diffused	8	45	30°	T-1 3/4 (5mm) With Spacer
L-7113BR-5.08/SRD L-7113BR-6.35/SRD L-7113BR-9.52/SRD L-7113BR-17.8/SRD L-7113BR-23.5/SRD	GaAlAs	640	red diffused	*110	*300	30°	
L-7113BR-5.08/YD L-7113BR-6.35/YD L-7113BR-9.52/YD L-7113BR-17.8/YD L-7113BR-23.5/YD	GaAsP/GaP	588	yellow diffused	5	20	30°	
L-7113BR-5.08/GD L-7113BR-6.35/GD L-7113BR-9.52/GD L-7113BR-17.8/GD L-7113BR-23.5/GD	GaP	568	green diffused	5	20	30°	
L-7113BR-5.08/SGD L-7113BR-6.35/SGD L-7113BR-9.52/SGD L-7113BR-17.8/SGD L-7113BR-23.5/SGD	GaP	568	green diffused	*18	*40	30°	

NOTES:
 1. All dimensions are in millimeters(inches).
 2. Tolerance is ±0.25mm(0.01") unless otherwise noted.

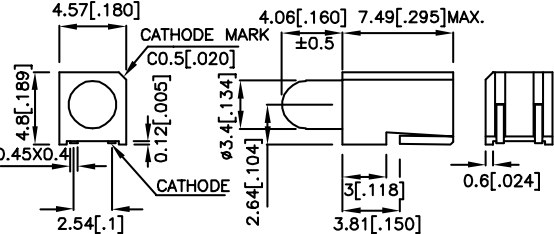
SMD CBI

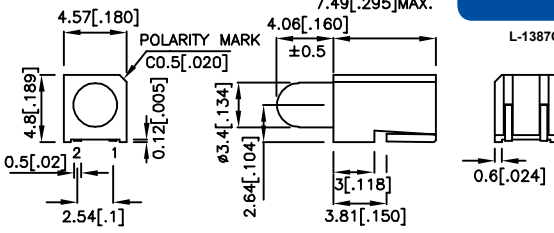
PART NUMBER	MATERIAL	λ_D (nm)	LENS TYPE	Iv (mcd) @10mA *20mA		VIEWING ANGLE 2 θ 1/2	DIMENSION
				MIN.	TYP.		
L-138A8QMP/1ID	GaAsP/GaP	625	red diffused	12	20	60°	3.4mm Right Angle  L-138A8QMP/1 
L-138A8QMP/1SRD	GaAlAs	640	red diffused	*110	*250	60°	
L-138A8QMP/1YD	GaAsP/GaP	588	yellow diffused	8	15	60°	
L-138A8QMP/1GD	GaP	568	green diffused	8	15	60°	
L-1387QMP/1EGW	GaAsP/GaP	625	white diffused	*7	*20	60°	3.4mm Right Angle  L-1387QMP/1 
	GaP	568		*7	*20		
L-1387QMP/1GYW	GaP	568	white diffused	*7	*20	60°	
	GaAsP/GaP	588		*4	*10		
L-1387QMP/1 SURKCGKW	AlGaInP	630	white diffused	*70	*300	60°	
	AlGaInP	570		*50	*120		
L-1387QMP/1 CGKQBDW	AlGaInP	570	white diffused	*50	*120	60°	
	InGaN	470		*50	*130		

VALUE ADDED LED LAMPS

LED lamp with forming/wire leads available

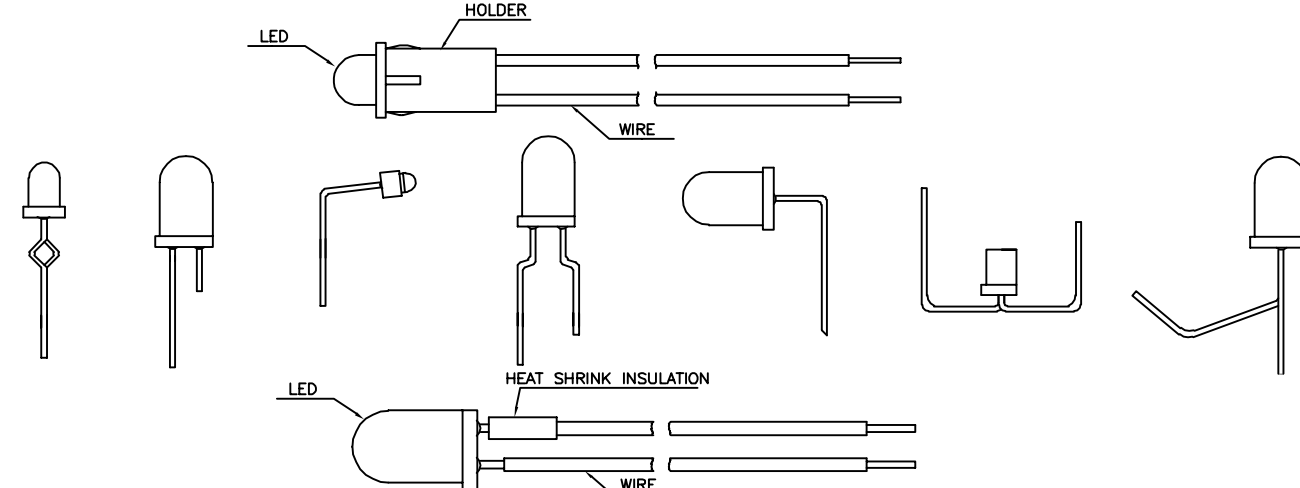

The diagrams illustrate different LED lamp styles and their assembly. One style shows an LED mounted on a holder with wires extending from the back. Another style shows an LED with wires attached to its leads. A third style shows an LED with heat shrink insulation applied to the base of its leads. The labels identify the LED, holder, wires, and heat shrink insulation components.

NOTES:
 1. All dimensions are in millimeters(inches).
 2. Tolerance is ±0.25mm(0.01") unless otherwise noted.

RTC-31

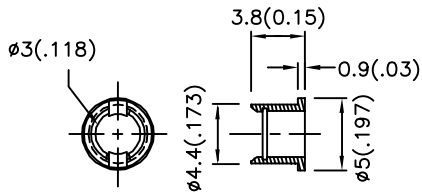

RTC-31

CB-30

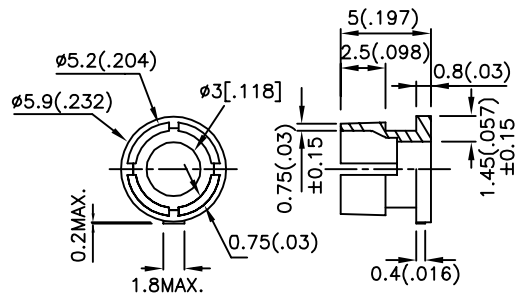

CB-30

RTC-32

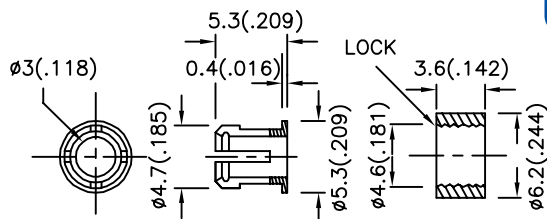

RTC-32

CB-50

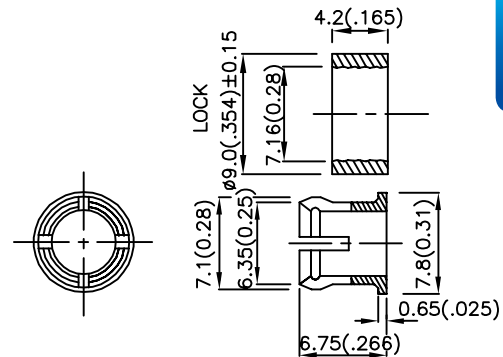

CB-50

RTC-51

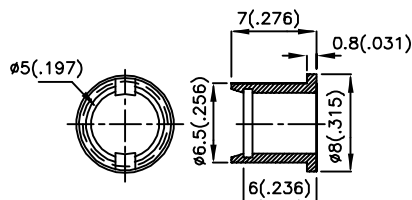

RTC-51

CB-55

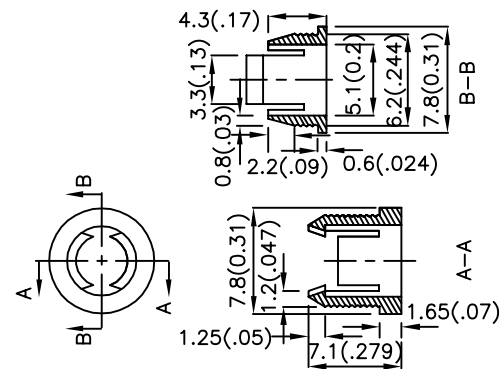

CB-55

RTC-52

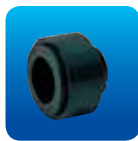
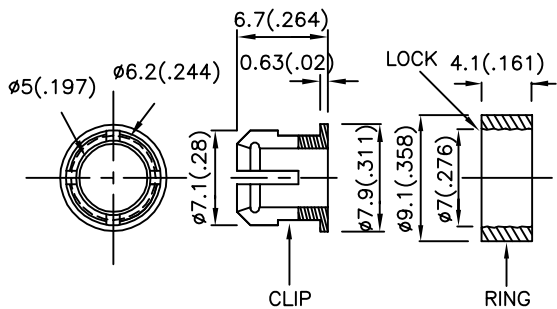

RTC-52

NOTES:

1. All dimensions are in millimeters(inches).
2. Tolerance is ±0.25mm(0.01") unless otherwise noted.

RTF-1090

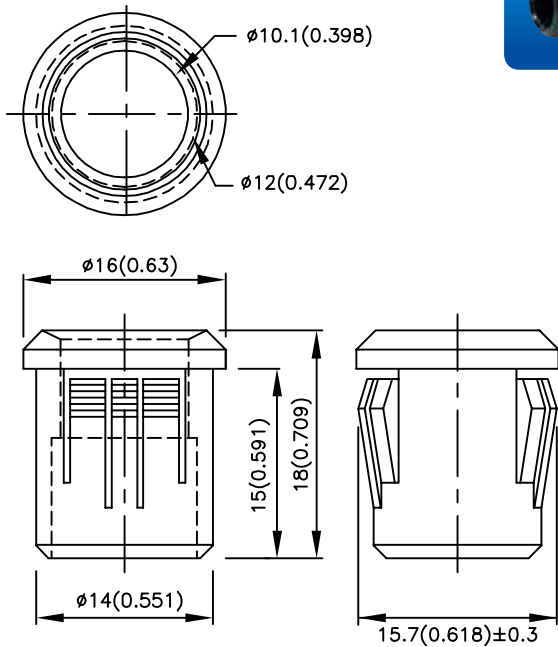

RTF-8080

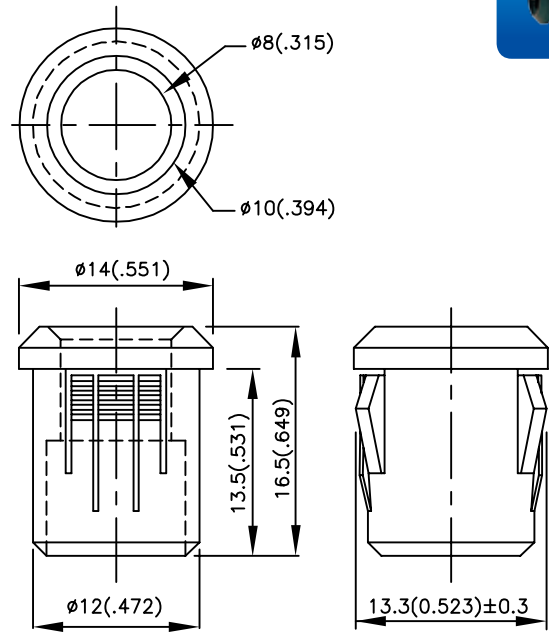

RTF-5010

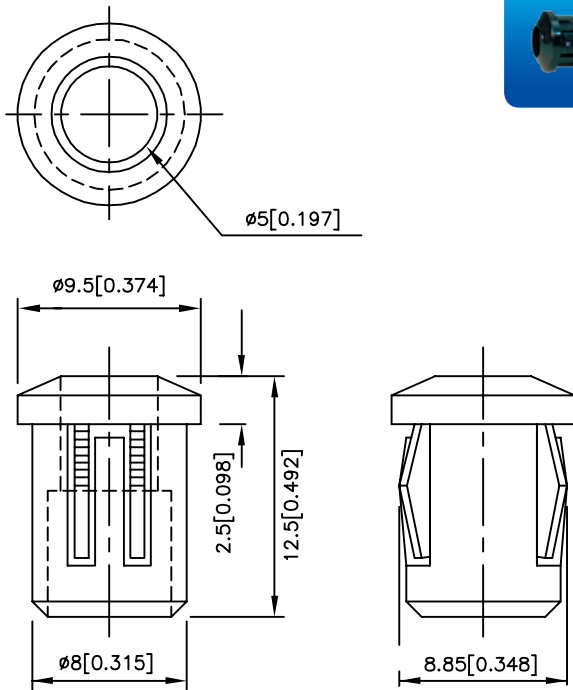

RTF-5020

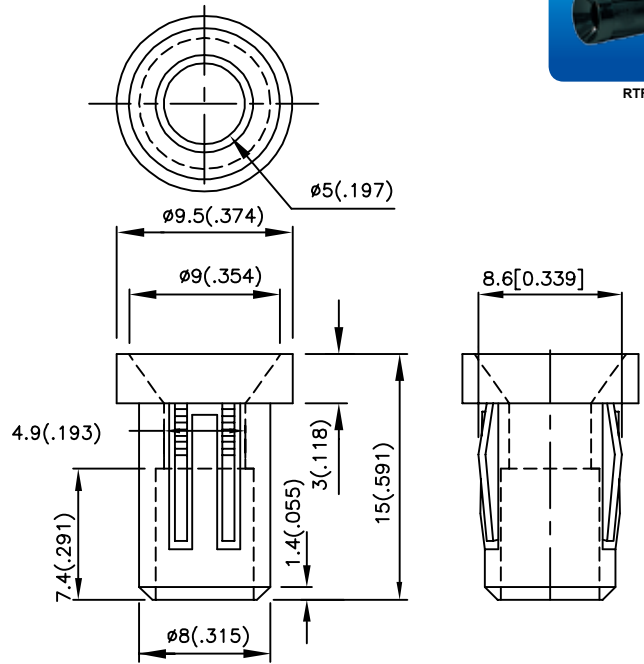

NOTES:

1. All dimensions are in millimeters(inches).
2. Tolerance is $\pm 0.25\text{mm}(0.01")$ unless otherwise noted.

Kingbright

Optoelectronic Components



Infrared & Phototransistor 88



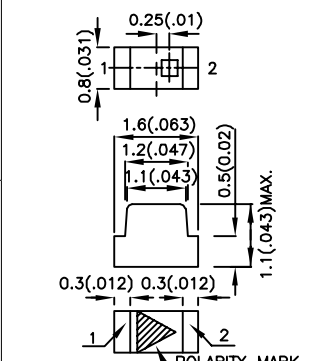
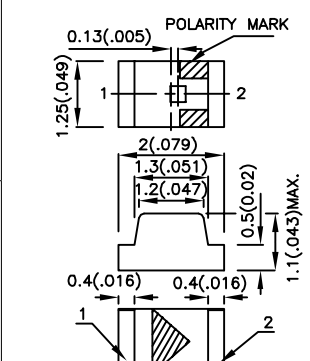
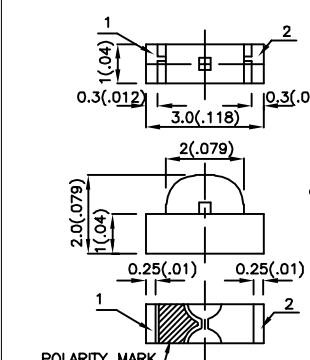
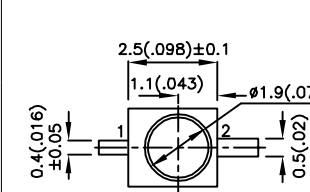
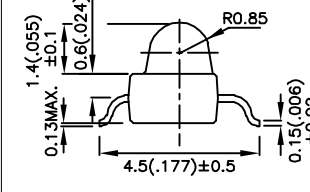

Infrared Emitting Diode 88

Phototransistor 90

INFRARED EMITTING DIODE

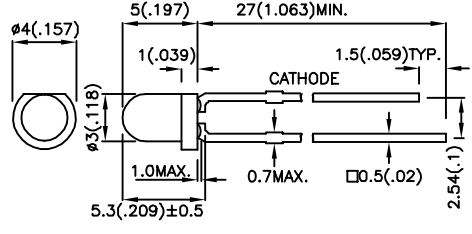
PART NUMBER	MATERIAL	λ_P (nm)	LENS TYPE	Po (mW/sr) @20mA *50mA		VIEWING ANGLE	DIMENSION
				MIN.	TYP.		
KP-1608F3C	GaAs	940	water clear	0.7	3	120°	1.6mm x 0.8mm x 1.1mm (0603)  Units : mm(inch) Tolerance : ±0.1(0.004)
KP-1608SF4C	GaAlAs	880	water clear	0.4	1.5	120°	
KP-2012F3C	GaAs	940	water clear	0.7	3	120°	2.0mm x 1.25mm x 1.1mm (0805)  Units : mm(inch) Tolerance : ±0.1(0.004)
KP-2012SF4C	GaAlAs	880	water clear	0.4	1.5	120°	
KPA-3010F3C	GaAs	940	water clear	0.7	2	120°	3.0mm x 1.0mm x 2.0mm (1104 Right Angle)  Units : mm(inch) Tolerance : ±0.15(0.006)
KM2520F3C03	GaAs	940	water clear	1.6	8	20°	2mm Subminiature IR Emitter  Units : mm(inch) Tolerance : ±0.25(0.01)
				*10	*15		
KM2520SF4C03	GaAlAs	880	water clear	1.6	4	20°	 Units : mm(inch) Tolerance : ±0.25(0.01)
				*2.6	*8		

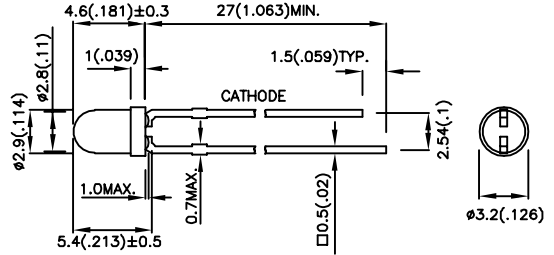
INFRARED EMITTING DIODE

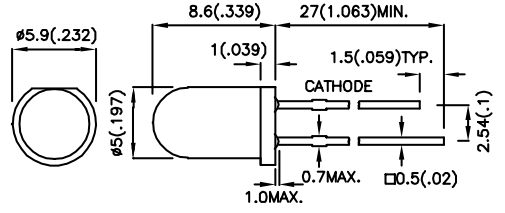
PART NUMBER	MATERIAL	λ_P (nm)	LENS TYPE	Po (mW/sr) @20mA *50mA		VIEWING ANGLE 2 θ 1/2	DIMENSION
				MIN.	TYP.		
L-34F3C	GaAs	● 940	water clear	7	40	50°	T-1 (3mm) Round  L-34F3C 
L-34F3BT	GaAs	● 940	blue transparent	4	40	50°	
L-34SF4C	GaAlAs	● 880	water clear	7	40	50°	
L-34SF4BT	GaAlAs	● 880	blue transparent	4	40	50°	
L-34SF6C	GaAlAs	● 860	water clear	7	15	50°	
L-34SF6BT	GaAlAs	● 860	blue transparent	7	15	50°	
L-34SF7C	GaAlAs	● 850	water clear	7	18	50°	
L-34SF7BT	GaAlAs	● 850	blue transparent	7	18	50°	
				*18	*55	50°	
				*10	*45	50°	
				*10	*45	50°	Units : mm(inch) Tolerance : ±0.25(0.01)
L-7104F3C	GaAs	● 940	water clear	7	30	34°	T-1 (3mm) Round  L-7104F3C 
				*18	*80	34°	
L-7104F3BT	GaAs	● 940	blue transparent	7	28	34°	Units : mm(inch) Tolerance : ±0.25(0.01)
				*18	*70	34°	
L-7113F3C	GaAs	● 940	water clear	7	30	20°	T-1 3/4 (5mm) Round  L-7113F3C 
L-7113F3BT	GaAs	● 940	blue transparent	4	20	20°	
L-7113SF4C	GaAlAs	● 880	water clear	7	20	20°	
L-7113SF4BT	GaAlAs	● 880	blue transparent	4	20	20°	
L-7113SF6C	GaAlAs	● 860	water clear	10	40	20°	
L-7113SF6BT	GaAlAs	● 860	blue transparent	10	40	20°	
L-7113SF7C	GaAlAs	● 850	water clear	10	40	20°	
L-7113SF7BT	GaAlAs	● 850	blue transparent	10	40	20°	
				*50	*100	20°	
				*50	*100	20°	

PHOTOTRANSISTOR

PART NUMBER		LENS TYPE		DIMENSION	
KP-1608P1C		WATER CLEAR		1.6mm x 0.8mm x 1.1mm (0603)	
KP-2012P3C		WATER CLEAR		2.0mm x 1.25mm x 1.1mm (0805)	
KP-3216P3C		WATER CLEAR		3.2mm x 1.6mm x 1.1mm (1206)	
KPA-3010P3C		WATER CLEAR		3.0mm x 1.0mm x 2.0mm (1104)	

ELECTRICAL AND RADIANT CHARACTERISTICS $T_A = 25^\circ\text{C}$

PARAMETER	SYMBOL	PART NUMBER	MIN.	TYP.	MAX.	UNIT	TEST CONDITION
Collector-to-Emitter Breakdown Voltage	$V_{BR\ CE0}$	-	30	-	-	V	$I_C = 100\mu\text{A}$ $E_e = 0\text{mW/cm}^2$
Emitter-to-Collector Breakdown Voltage	$V_{BR\ ECO}$	-	5	-	-	V	$I_E = 100\mu\text{A}$ $E_e = 0\text{mW/cm}^2$
Collector-to-Emitter Saturation Voltage	$V_{CE\ (SAT)}$	-	-	-	0.8	V	$I_C = 2\text{mA}$ $E_e = 20\text{mW/cm}^2$
Collector Dark Current	I_{CEO}	-	-	-	100	nA	$V_{CE} = 10\text{V}$ $E_e = 0\text{mW/cm}^2$
Rise Time (10% to 90%)	T_R	-	-	15	-	μs	$V_{CE} = 5\text{V}$ $I_C = 1\text{mA}$ $R_L = 1\text{K}\Omega$
Fall Time (90% to 10%)	T_F	-	-	15	-	μs	
On State Collector Current	$I_{(ON)}$	KP-1608P1C	0.1	0.3	-	mA	$V_{CE} = 5\text{V}$ $E_e = 1\text{mW/cm}^2$ $\lambda = 940\text{nm}$
		KP-2012P3C	0.1	0.3			
		KP-3216P3C	0.1	0.3			
		KPA-3010P3C	0.1	0.3			



KP-1608P1C



KP-2012P3C



KP-3216P3C



KPA-3010P3C

ABSOLUTE MAXIMUM RATING $T_A = 25^\circ\text{C}$

PARAMETER	MAXIMUM RATINGS
Collector-to-Emitter Voltage	30V
Emitter-to-Collector Voltage	5V
Power Dissipation at (or below) 25°C Free Air Temperature	100mW
Operating Temperature Range	$-40^\circ\text{C} \sim +85^\circ\text{C}$
Storage Temperature Range	$-40^\circ\text{C} \sim +85^\circ\text{C}$

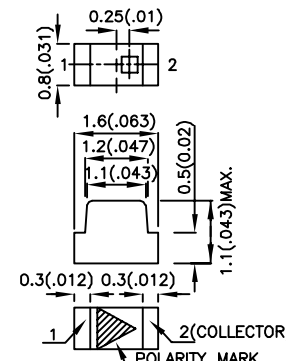

Units : mm(inch)
Tolerance : $\pm 0.1(0.004)$

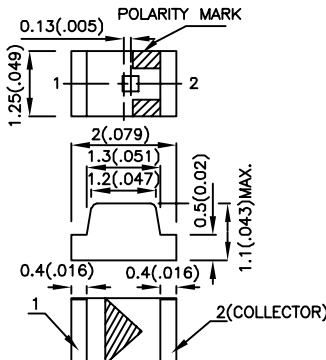

Units : mm(inch)
Tolerance : $\pm 0.1(0.004)$

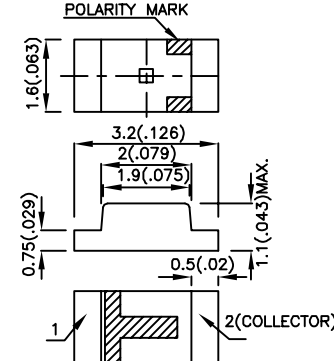

Units : mm(inch)
Tolerance : $\pm 0.1(0.004)$

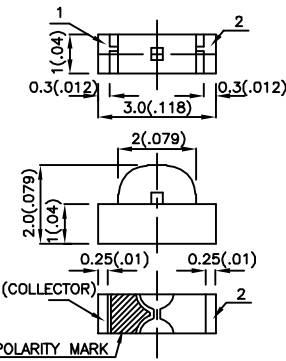

Units : mm(inch)
Tolerance : $\pm 0.15(0.006)$

PHOTOTRANSISTOR

PART NUMBER	LENS TYPE	DIMENSION
L-3DP3BT	BLUE TRANSPARENT	T-1 (3mm) PHOTOTRANSISTOR  L-3DP3BT
L-7113P3C	WATER CLEAR	

ELECTRICAL AND RADIANT CHARACTERISTICS $T_A = 25^\circ\text{C}$

PARAMETER	SYMBOL	PART NUMBER	MIN.	TYP.	MAX.	UNIT	TEST CONDITION
Collector-to-Emitter Breakdown Voltage	$V_{BR\ CE0}$	-	30	-	-	V	$I_C=100\mu\text{A}$ $E_e=0\text{mW}/\text{cm}^2$
Emitter-to-Collector Breakdown Voltage	$V_{BR\ ECO}$	-	5	-	-	V	$I_E=100\mu\text{A}$ $E_e=0\text{mW}/\text{cm}^2$
Collector-to-Emitter Saturation Voltage	$V_{CE(SAT)}$	-	-	-	0.8	V	$I_C=2\text{mA}$ $E_e=20\text{mW}/\text{cm}^2$
Collector Dark Current	I_{CEO}	-	-	-	100	nA	$V_{CE}=10\text{V}$ $E_e=0\text{mW}/\text{cm}^2$
Rise Time (10% to 90%)	T_R	-	-	15	-	μs	$V_{CE}=5\text{V}$ $I_C=1\text{mA}$ $R_L=1\text{K}\Omega$
Fall Time (90% to 10%)	T_F	-	-	15	-	μs	
On State Collector Current	$I_{(ON)}$	L-3DP3BT	0.2	0.5	-	mA	$V_{CE}=5\text{V}$, $E_e=1\text{mW}/\text{cm}^2$ $\lambda=940\text{nm}$
		L-7113P3C	0.1	0.5	-		

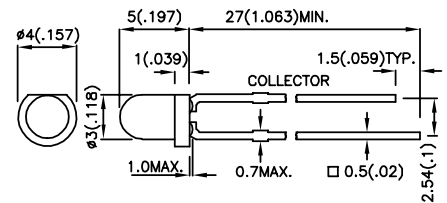

Units : mm(inch)
Tolerance : $\pm 0.25(0.01)$

T-1 3/4 (5mm) PHOTOTRANSISTOR



ABSOLUTE MAXIMUM RATING $T_A = 25^\circ\text{C}$

PARAMETER	MAXIMUM RATINGS
Collector-to-Emitter Voltage	30V
Emitter-to-Collector Voltage	5V
Power Dissipation at (or below) 25°C Free Air Temperature	100mW
Operating Temperature Range	$-40^\circ\text{C} \sim +85^\circ\text{C}$
Storage Temperature Range	$-40^\circ\text{C} \sim +85^\circ\text{C}$
Lead Soldering Temperature (>5mm For 5sec)	260°C

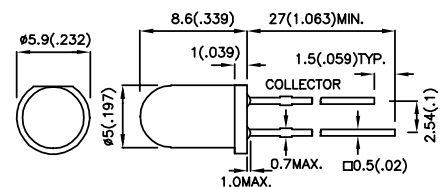

Units : mm(inch)
Tolerance : $\pm 0.25(0.01)$

Kingbright

Optoelectronic Components



Light Pipe 92

Based LED lamps 93

Cluster 94

KL-05



KL-05

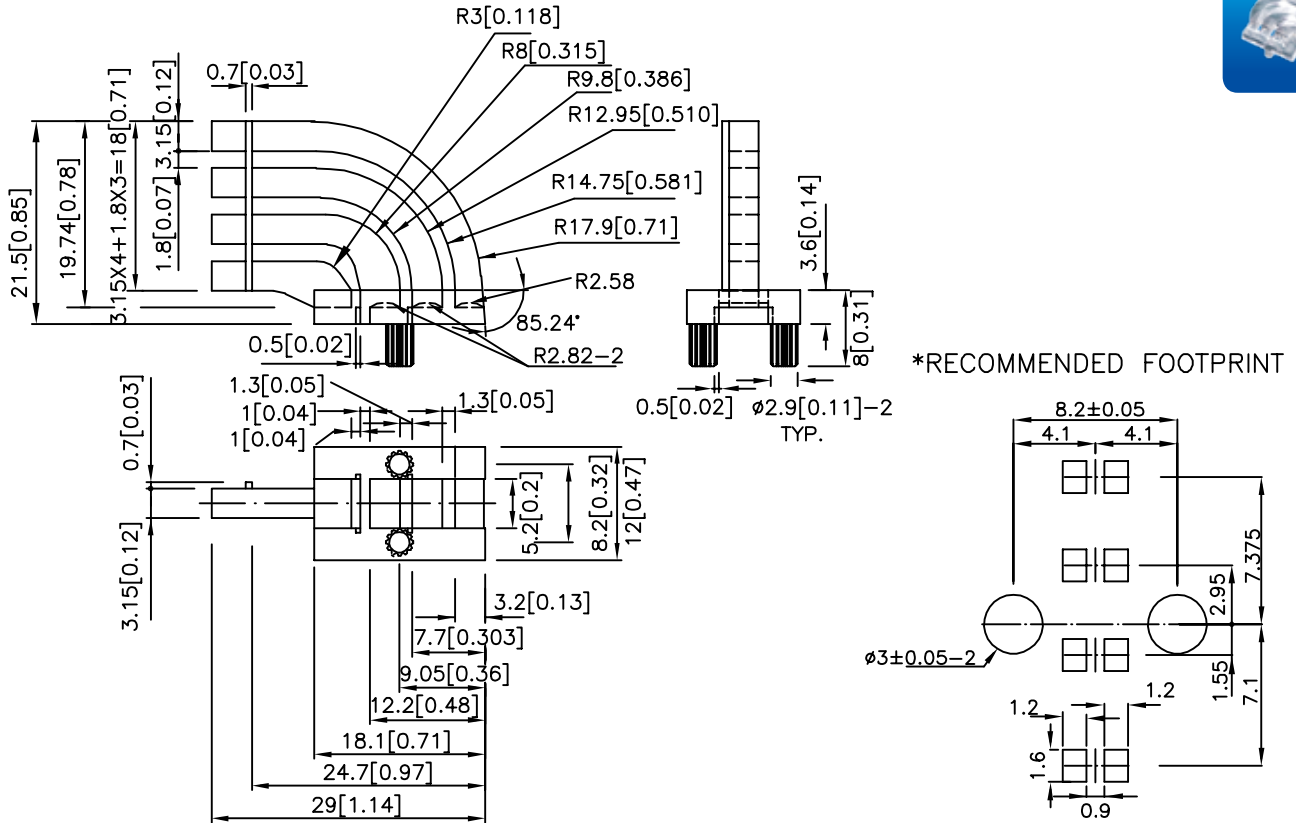

KL-07LS



KL-07LS

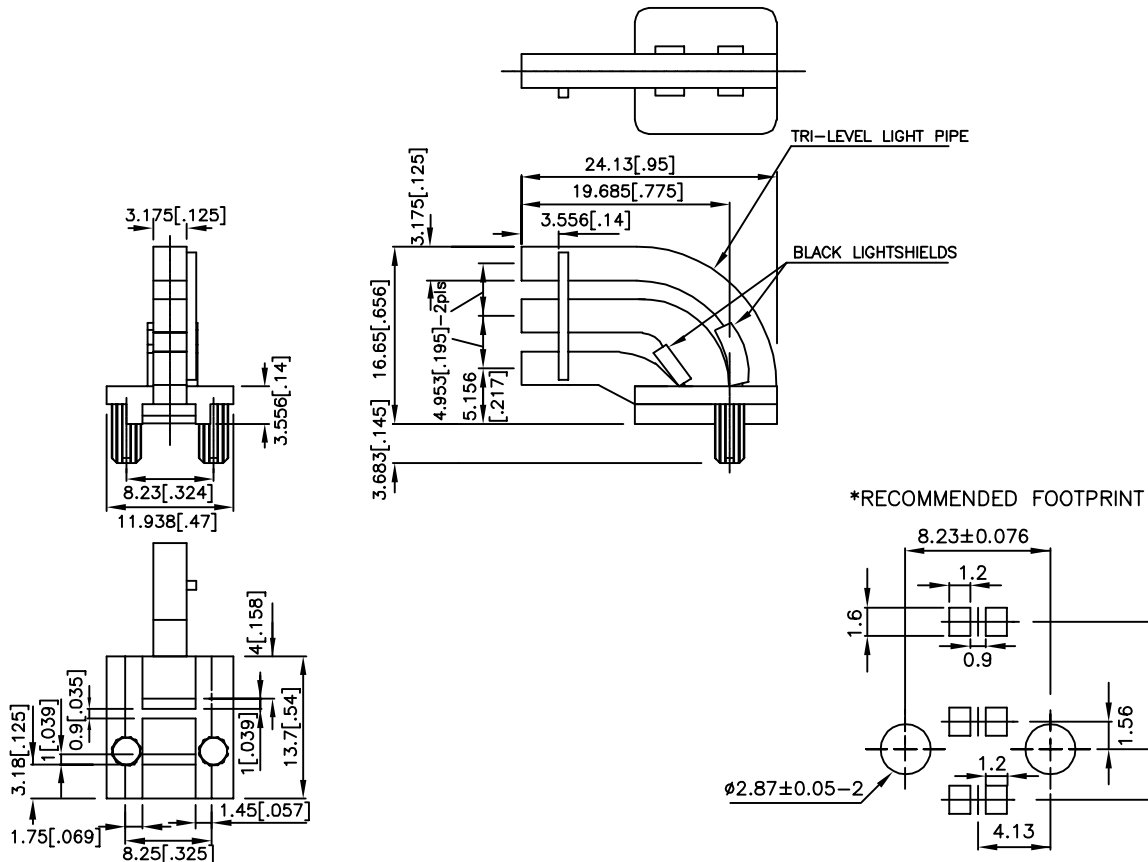

NOTES:

1. All dimensions are in millimeters(inches).
2. Tolerance is ±0.25mm(0.01") unless otherwise noted.

BAYONET BASE

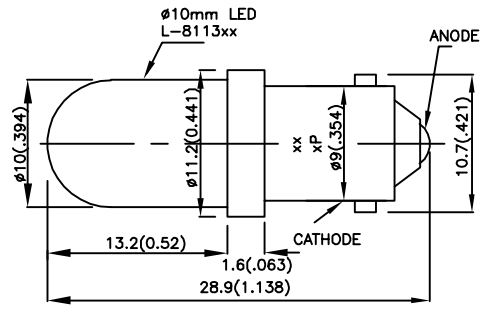
PART NUMBER	MATERIAL	λ_D (nm)	LENS TYPE	Iv (mcd)		VIEWING ANGLE	DIMENSION
				*V=12V MIN.	V=6V **V=28V TYP.		
BLB101SURC-E-6V-P	AlGaInP	630	water clear	1800	3300	20°	10mm Bayonet Base  
BLB101SURC-E-12V-P	AlGaInP	630	water clear	*1500	*2500	20°	
BLB101SURC-E-28V-P	AlGaInP	630	water clear	**1200	**2100	20°	
BLB101SYC-6V-P	AlGaInP	590	water clear	1500	2500	20°	
BLB101SYC-12V-P	AlGaInP	590	water clear	*900	*1800	20°	
BLB101SYC-28V-P	AlGaInP	590	water clear	**650	**1400	20°	
BLB101MGC-6V-P	AlGaInP	570	water clear	380	900	20°	
BLB101MGC-12V-P	AlGaInP	570	water clear	*280	*800	20°	
BLB101MGC-28V-P	AlGaInP	570	water clear	**180	**600	20°	

SCREW BASE

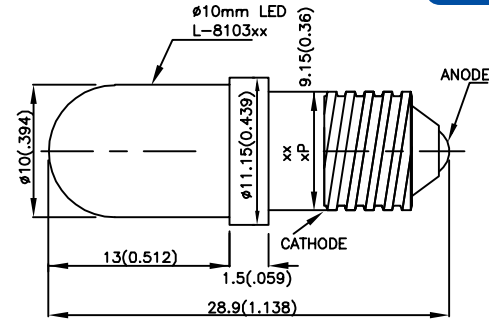
PART NUMBER	MATERIAL	λ_D (nm)	LENS TYPE	Iv (mcd)		VIEWING ANGLE	DIMENSION
				*V=12V MIN.	V=6V **V=28V TYP.		
BLS101SURC-E-6V-P	AlGaInP	630	water clear	1800	3100	20°	10mm Screw Base  
BLS101SURC-E-12V-P	AlGaInP	630	water clear	*1200	*2500	20°	
BLS101SURC-E-28V-P	AlGaInP	630	water clear	**900	**2100	20°	
BLS101SYC-6V-P	AlGaInP	590	water clear	1500	2800	20°	
BLS101SYC-12V-P	AlGaInP	590	water clear	*1200	*2300	20°	
BLS101SYC-28V-P	AlGaInP	590	water clear	**650	**1800	20°	
BLS101MGC-6V-P	AlGaInP	570	water clear	480	1100	20°	
BLS101MGC-12V-P	AlGaInP	570	water clear	*380	*1000	20°	
BLS101MGC-28V-P	AlGaInP	570	water clear	**280	**800	20°	

NOTES:

1. All dimensions are in millimeters(inches).
2. Tolerance is $\pm 0.25\text{mm}(0.01")$ unless otherwise noted.

28mmX28mm

PART NUMBER	MATERIAL	λ_D (nm)	LENS TYPE	Iv (mcd)		VIEWING ANGLE	IF(mA)
				MIN.	TYP.		
BL0709-18-462	GaAlAs	640	water clear	900	1800	40°	20
	InGaN	470	water clear	280	650	40°	20
	GaP	568	water clear	650	1200	40°	40

26mm

PART NUMBER	MATERIAL	λ_D (nm)	LENS TYPE	Iv (mcd)		VIEWING ANGLE	IF(mA)
				MIN.	TYP.		
BL0102-14-34	GaAlAs	640	water clear	1500	2800	40°	20
	GaP	568	water clear	650	1600	40°	40

52mm

PART NUMBER	MATERIAL	λ_D (nm)	LENS TYPE	Iv (mcd)		VIEWING ANGLE	IF(mA)
				MIN.	TYP.		
BL0307-50-360	AlGaInP	570	water clear	7500	12000	40°	200
BL0307-50-374	AlGaInP	590	water clear	7500	15000	40°	200
BL0307-50-433	AlGaInP	630	water clear	8000	16000	40°	200

NOTES:
 1. All dimensions are in millimeters(inches).
 2. Tolerance is $\pm 0.25\text{mm}(0.01\text{'})$ unless otherwise noted.

Kingbright

Optoelectronic Components



Photocouplers **95**

Photo Interrupters **99**

Photo Reflective Sensor **104**

PART NUMBER	PIN CONFIGURATION	SAFETY STANDARDS	FEATURES	ABSOLUTE MAXIMUM RATINGS		ELECTRICAL CHARACTERISTICS					
				ISOLATION VOLTAGE(AC) VISO(Vrms)	COLLECTOR EMITTER VOLTAGE V _{CEO} (V)	CTR(%)		V(sat) (V)		RESPONSE TIME (μs) TYP.	
						IF=±1mA, V _{CE} =5V		IF=±20mA, I _C =1mA		V _{CE} =2V, I _C =2mA, R _L =100Ω	
						MIN.	MAX.	TYP.	MAX.	TR	TF
KB814		UL NO.E225308 & VDE0884. NO.40006364	High isolation voltage AC input response	5000	35	20	300	0.1	0.2	4	3

PART NUMBER	PIN CONFIGURATION	SAFETY STANDARDS	FEATURES	ABSOLUTE MAXIMUM RATINGS		ELECTRICAL CHARACTERISTICS					
				ISOLATION VOLTAGE(AC) VISO(Vrms)	COLLECTOR EMITTER VOLTAGE V _{CEO} (V)	CTR(%)		V(sat) (V)		RESPONSE TIME (μs) TYP.	
						IF=±1mA, V _{CE} =2V		IF=±20mA, I _C =5mA		V _{CE} =2V, I _C =10mA, R _L =100Ω	
						MIN.	MAX.	TYP.	MAX.	TR	TF
KB8141		UL NO.E225308 & VDE0884. NO.40006364	High isolation voltage High sensitivity AC input response	5000	35	600	7500	0.8	1	60	53

PART NUMBER	PIN CONFIGURATION	SAFETY STANDARDS	FEATURES	ABSOLUTE MAXIMUM RATINGS		ELECTRICAL CHARACTERISTICS					
				ISOLATION VOLTAGE(AC) VISO(Vrms)	COLLECTOR EMITTER VOLTAGE V _{CEO} (V)	CTR(%)		V(sat) (V)		RESPONSE TIME (μs) TYP.	
						IF=1mA, V _{CE} =2V		IF=20mA, I _C =5mA		V _{CE} =2V, I _C =10mA, R _L =100Ω	
						MIN.	MAX.	TYP.	MAX.	TR	TF
KB815		UL NO.E225308 & VDE0884. NO.40006364	High isolation voltage High sensitivity	5000	35	600	7500	0.8	1	60	53

PART NUMBER	PIN CONFIGURATION	SAFETY STANDARDS	FEATURES	ABSOLUTE MAXIMUM RATINGS		ELECTRICAL CHARACTERISTICS					
				ISOLATION VOLTAGE(AC) VISO(Vrms)	COLLECTOR EMITTER VOLTAGE V _{CEO} (V)	CTR(%)		V(sat) (V)		RESPONSE TIME (μs) TYP.	
						IF=5mA, V _{CE} =5V		IF=20mA, I _C =1mA		V _{CE} =2V, I _C =2mA, R _L =100Ω	
						MIN.	MAX.	TYP.	MAX.	TR	TF
KB816		UL NO.E225308 & VDE0884. NO.40006364	High isolation voltage High collector-emitter voltage	5000	70	50	600	0.1	0.2	4	3

PART NUMBER	PIN CONFIGURATION	SAFETY STANDARDS	FEATURES	ABSOLUTE MAXIMUM RATINGS		ELECTRICAL CHARACTERISTICS					
				ISOLATION VOLTAGE(AC) VISO(Vrms)	COLLECTOR EMITTER VOLTAGE V _{CEO} (V)	CTR(%)		V(sat) (V)		RESPONSE TIME (μs) TYP.	
						IF=5mA, V _{CE} =5V		IF=20mA, I _C =1mA		V _{CE} =2V, I _C =2mA, R _L =100Ω	
						MIN.	MAX.	TYP.	MAX.	TR	TF
KB817		UL NO.E225308 & VDE0884. NO.40006364	High isolation voltage	5000	35	50	600	0.1	0.2	4	3

PART NUMBER	PIN CONFIGURATION	SAFETY STANDARDS	FEATURES	ABSOLUTE MAXIMUM RATINGS		ELECTRICAL CHARACTERISTICS					
				ISOLATION VOLTAGE(AC) VISO(Vrms)	COLLECTOR EMITTER VOLTAGE V _{CEO} (V)	CTR(%)		V(sat) (V)		RESPONSE TIME (μs) TYP.	
						IF=5mA, V _{CE} =5V	IF=20mA, I _C =1mA	V _{CE} =2V, I _C =2mA, R _L =100Ω	MIN.	MAX.	TYP
KB851		VDE0884. NO.40006364	High collector-emitter Voltage	5000	350	-	-	0.1	0.3	4	3

PART NUMBER	PIN CONFIGURATION	SAFETY STANDARDS	FEATURES	ABSOLUTE MAXIMUM RATINGS		ELECTRICAL CHARACTERISTICS					
				ISOLATION VOLTAGE(AC) VISO(Vrms)	COLLECTOR EMITTER VOLTAGE V _{CEO} (V)	CTR(%)		V(sat) (V)		RESPONSE TIME (μs) TYP.	
						IF=1mA, V _{CE} =2V	IF=20mA, I _C =100mA	V _{CE} =2V, I _C =20mA, R _L =1000Ω	MIN.	MAX.	TYP
KB852		VDE0884. NO.40006364	High collector-emitter voltage High sensitivity	5000	350	1000	15000	-	1.2	100	20

PART NUMBER	PIN CONFIGURATION	SAFETY STANDARDS	FEATURES	ABSOLUTE MAXIMUM RATINGS		ELECTRICAL CHARACTERISTICS					
				ISOLATION VOLTAGE(AC) VISO(Vrms)	COLLECTOR EMITTER VOLTAGE V _{CEO} (V)	CTR(%)		V(sat) (V)		RESPONSE TIME (μs) TYP.	
						IF=5mA, V _{CE} =5V	IF=20mA, I _C =1mA	V _{CE} =2V, I _C =2mA, R _L =100Ω	MIN.	MAX.	TYP
KB817-B		UL NO.E225308 & VDE0884. NO.40006364	High isolation voltage SMD Type	5000	35	50	600	0.1	0.2	4	3

PART NUMBER	PIN CONFIGURATION	SAFETY STANDARDS	FEATURES	ABSOLUTE MAXIMUM RATINGS		ELECTRICAL CHARACTERISTICS					
				ISOLATION VOLTAGE(AC) VISO(Vrms)	COLLECTOR EMITTER VOLTAGE V _{CEO} (V)	CTR(%)		V(sat) (V)		RESPONSE TIME (μs) TYP.	
						IF=5mA, V _{CE} =5V	IF=20mA, I _C =1mA	V _{CE} =2V, I _C =2mA, R _L =100Ω	MIN.	MAX.	TYP
KB817-M		UL NO.E225308 & VDE0884. NO.40006364	High isolation voltage	5000	35	50	600	0.1	0.2	4	3

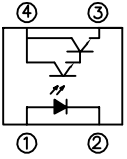
PART NUMBER	PIN CONFIGURATION	SAFETY STANDARDS	FEATURES	ABSOLUTE MAXIMUM RATINGS		ELECTRICAL CHARACTERISTICS					
				ISOLATION VOLTAGE(AC) VISO(Vrms)	COLLECTOR EMITTER VOLTAGE V _{CEO} (V)	CTR(%)		V(sat) (V)		RESPONSE TIME (μs) TYP.	
						IF=1mA, V _{CE} =2V		IF=20mA, I _C =1mA		V _{CE} =2V, I _C =2mA, R _L =100Ω	
						MIN.	MAX.	TYP.	MAX.	TR	TF
KB355NT		UL NO.E225308 & VDE0884. NO.40017614	High current transfer ratio Small package size	3750	35	600	7500	0.8	1.0	60	53

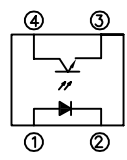
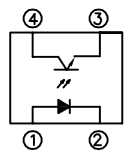
PART NUMBER	PIN CONFIGURATION	SAFETY STANDARDS	FEATURES	ABSOLUTE MAXIMUM RATINGS		ELECTRICAL CHARACTERISTICS					
				ISOLATION VOLTAGE(AC) VISO(Vrms)	COLLECTOR EMITTER VOLTAGE V _{CEO} (V)	CTR(%)		V(sat) (V)		RESPONSE TIME (μs) TYP.	
						IF=5mA, V _{CE} =5V		IF=20mA, I _C =1mA		V _{CE} =2V, I _C =2mA, R _L =100Ω	
						MIN.	MAX.	TYP.	MAX.	TR	TF
KB356NT		UL NO.E225308 & VDE0884. NO.40017614	High collector-emitter Voltage Small package size	3750	80	50	600	0.1	0.2	6	8
KB357NT			Small package size	3750	35	50	600	-	0.2	4	3

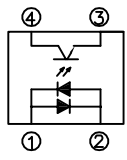
PART NUMBER	PIN CONFIGURATION	SAFETY STANDARDS	FEATURES	ABSOLUTE MAXIMUM RATINGS		ELECTRICAL CHARACTERISTICS					
				ISOLATION VOLTAGE(AC) VISO(Vrms)	COLLECTOR EMITTER VOLTAGE V _{CEO} (V)	CTR(%)		V(sat) (V)		RESPONSE TIME (μs) TYP.	
						IF=±1mA, V _{CE} =5V		IF=±20mA, I _C =1mA		V _{CE} =2V, I _C =2mA, R _L =100Ω	
						MIN.	MAX.	TYP.	MAX.	TR	TF
KB354NT		UL NO.E225308 & VDE0884. NO.40017614	AC.input response Small package size	3750	35	20	400	0.1	0.2	4	3

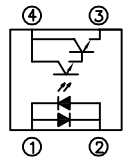
PART NUMBER	PIN CONFIGURATION	SAFETY STANDARDS	FEATURES	ABSOLUTE MAXIMUM RATINGS		ELECTRICAL CHARACTERISTICS					
				ISOLATION VOLTAGE(AC) VISO(Vrms)	COLLECTOR EMITTER VOLTAGE V _{CEO} (V)	CTR(%)		V(sat) (V)		RESPONSE TIME (μs) TYP.	
						IF=±1mA, V _{CE} =2V		IF=±20mA, I _C =1mA		V _{CE} =2V, I _C =2mA, R _L =100Ω	
						MIN.	MAX.	TYP.	MAX.	TR	TF
KB3541NT		UL NO.E225308 & VDE0884. NO.40017614	AC.input response High sensitivity Small package size	3750	35	450	7400	0.8	1.0	60	53

KB814, KB8141, KB815, KB816, KB817, KB851, KB852

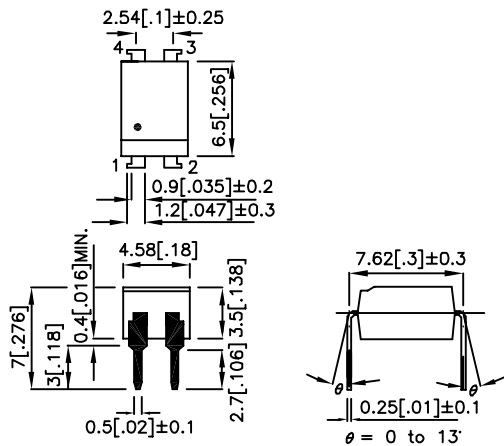

KB814



KB8141



KB815



KB816



KB817



KB851



KB852

KB817-B

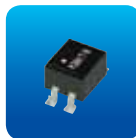

KB817-B

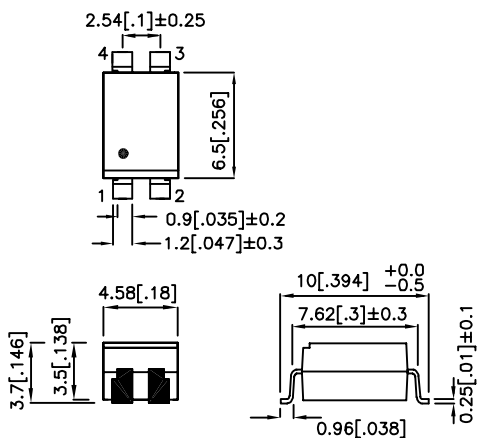

KB817-M



KB817-M

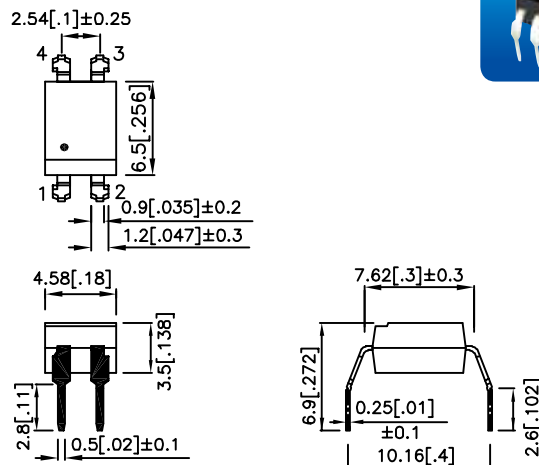

KB355NT, KB356NT, KB357NT, KB354NT, KB3541NT

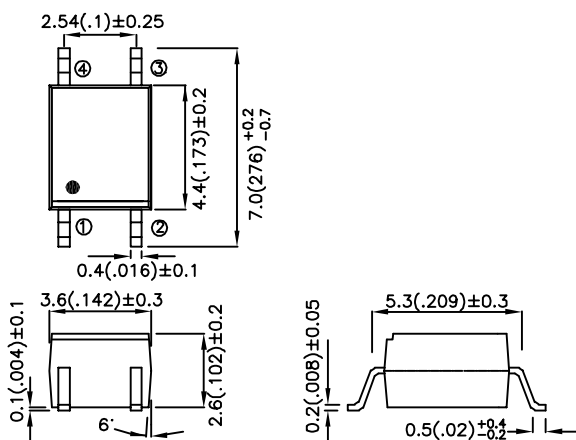

KB355NT



KB356NT



KB357NT



KB354NT



KB3541NT

NOTES:

1. All dimensions are in millimeters (inches).
2. Tolerance is ±0.5mm (0.02") unless otherwise noted.

PART NUMBER	PIN CONFIGURATION	MATERIAL	λ_p (nm)	CTR			$V_{CE(SAT)}$			RISE TIME (μs)	FALL TIME (μs)
				IF(mA)	$V_{CE(V)}$	TYP.(%)	IF(mA)	IC(mA)	MAX.(V)	TYP.	TYP.
KTIR0511S		GaAs/SiC	940	20	5	10	40	1	0.4	5	4
KTIR0521DS		GaAs/SiC	940	1	2	180	2	1	1	90	80
KTIR0611S		GaAs/SiC	940	20	5	14	40	1	0.4	5	4
KTIR0621DS		GaAs/SiC	940	1	2	200	2	1	1	90	80

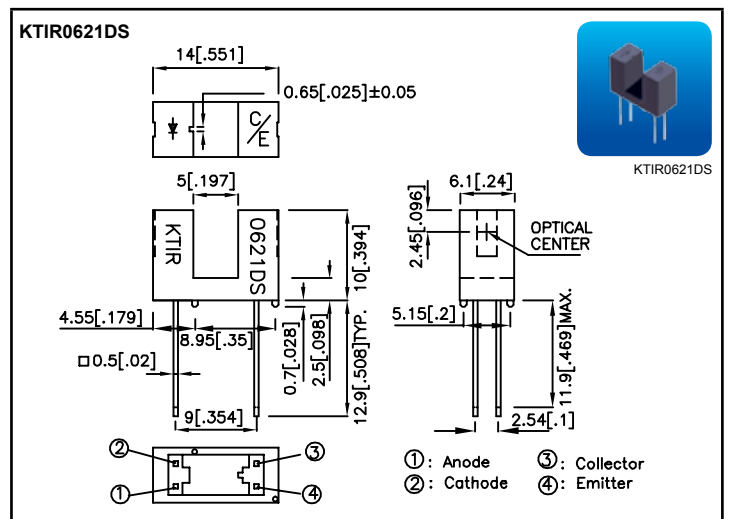
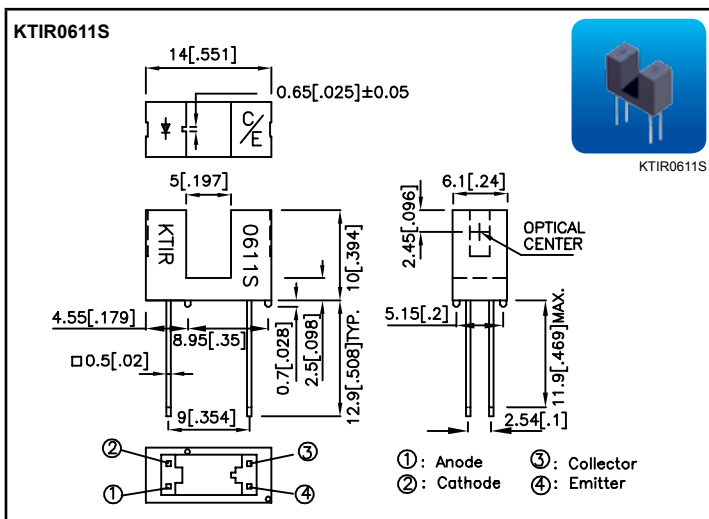
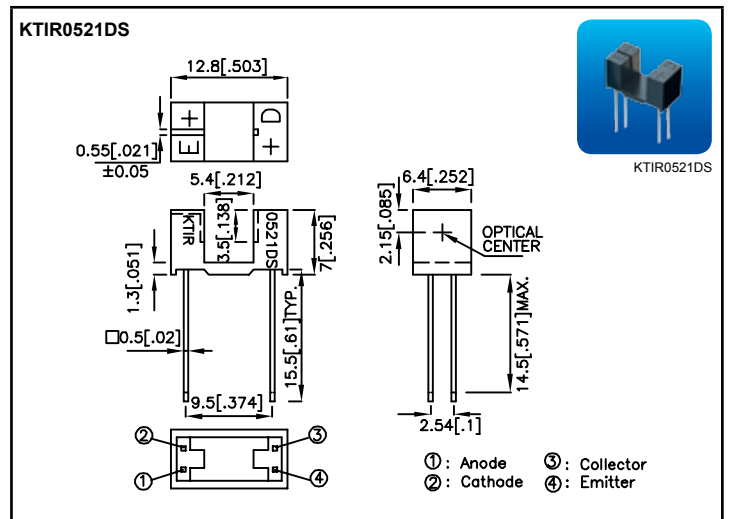
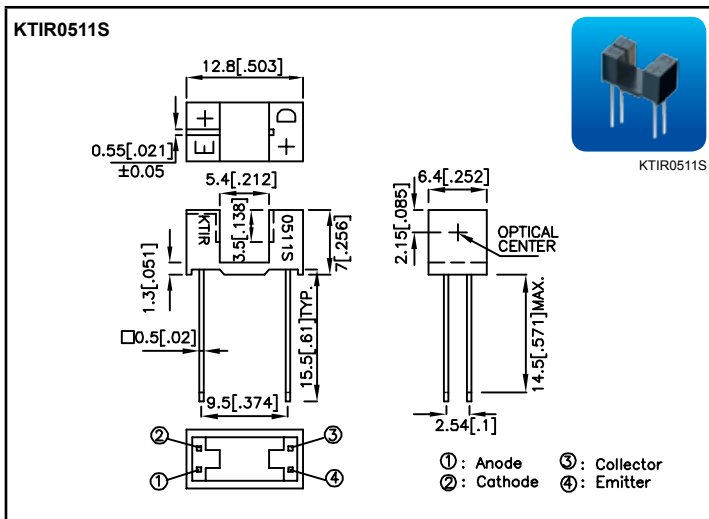

NOTES:

1. All dimensions are in millimeters(inches).
2. Tolerance is $\pm 0.25mm(0.01")$ unless otherwise noted.

PART NUMBER	PIN CONFIGURATION	MATERIAL	λ P (nm)	CTR			$V_{CE(SAT)}$			RISE TIME (μ s)	FALL TIME (μ s)
				IF(mA)	V_{CE} (V)	TYP.(%)	IF(mA)	IC(mA)	MAX.(V)	TYP.	TYP.
KTIR0311S		GaAs/SiC	940	20	5	38	40	1	0.4	5	4
KTIR0321DS		GaAs/SiC	940	1	2	650	2	1	1	90	80
KTIR0411S		GaAs/SiC	940	20	5	38	40	1	0.4	5	4
KTIR0421DS		GaAs/SiC	940	1	2	650	2	1	1	90	80

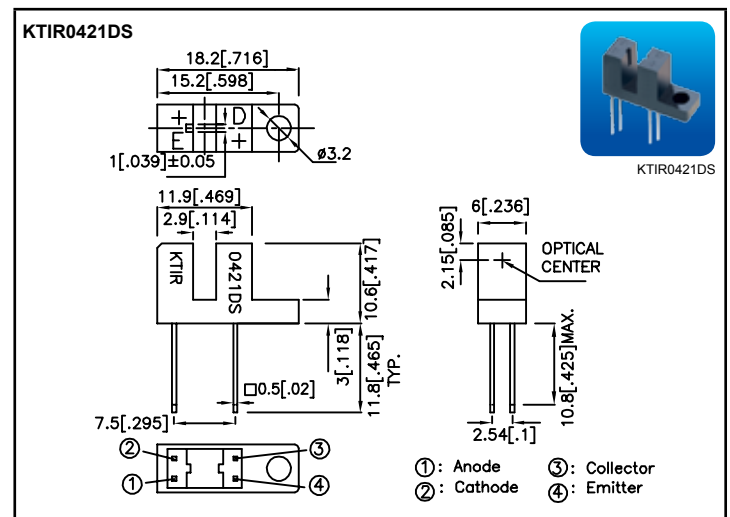
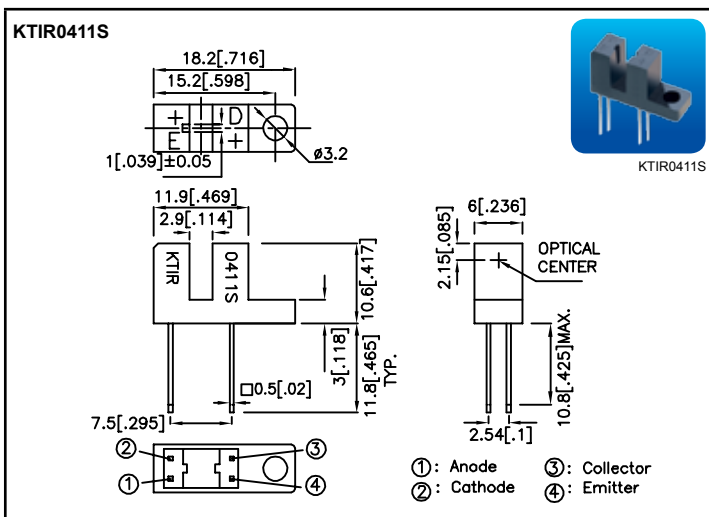
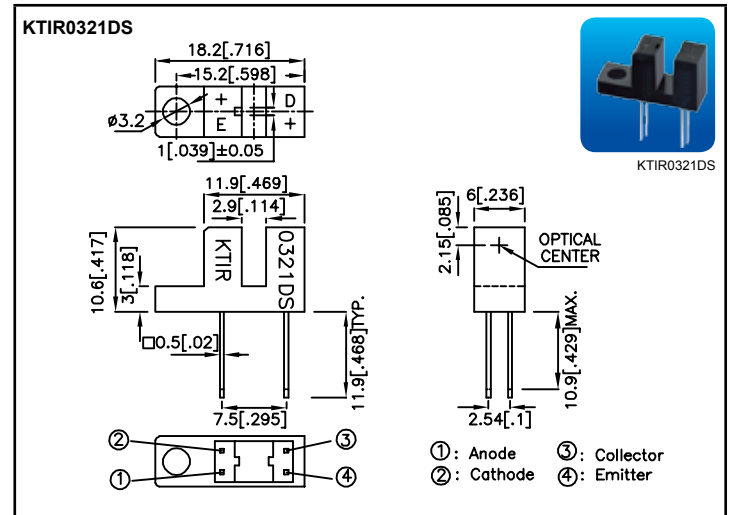
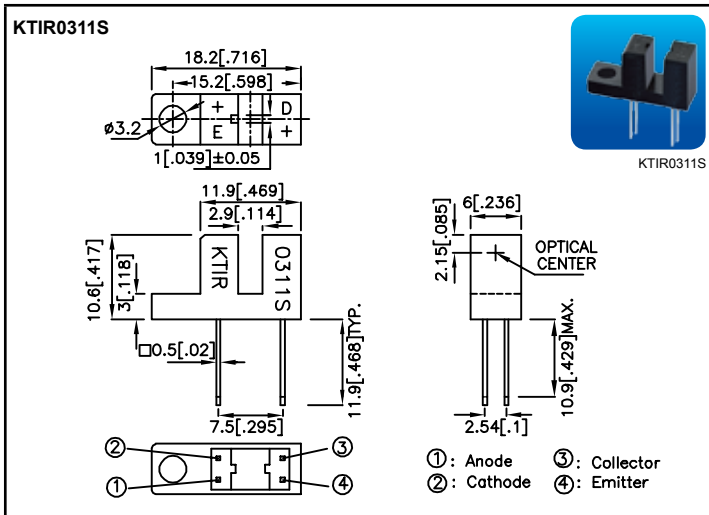

NOTES:
1. All dimensions are in millimeters (inches).
2. Tolerance is \pm 0.25mm (0.01") unless otherwise noted.

PART NUMBER	PIN CONFIGURATION	MATERIAL	λ_P (nm)	CTR			$V_{CE(SAT)}$			RISE TIME (μs)	FALL TIME (μs)
				IF(mA)	$V_{CE(V)}$	TYP.(%)	IF(mA)	IC(mA)	MAX.(V)	TYP.	TYP.
KTIR0911S		GaAs/SiC	● 940	20	5	9.5	40	1	0.4	5	4
KTIR0921DS		GaAs/SiC	● 940	1	2	120	2	1	1	90	80
KTIR0121DS		GaAs/SiC	● 940	1	2	600	2	1	1	90	80
KTIR0221DS		GaAs/SiC	● 940	1	2	600	2	1	1	90	80

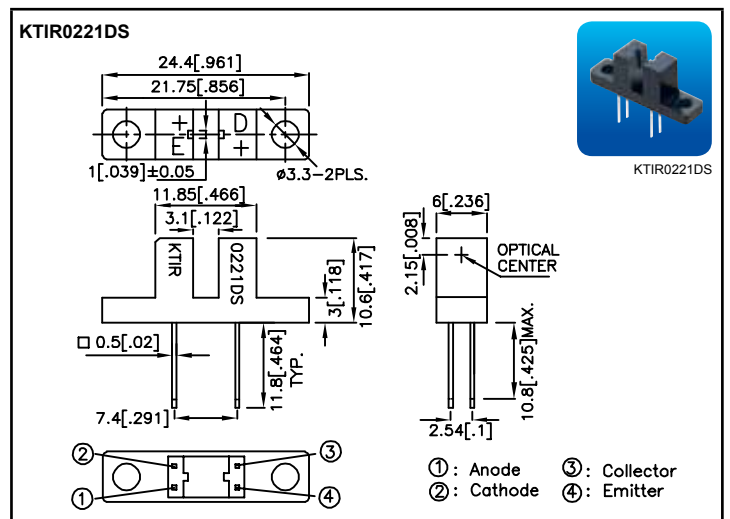
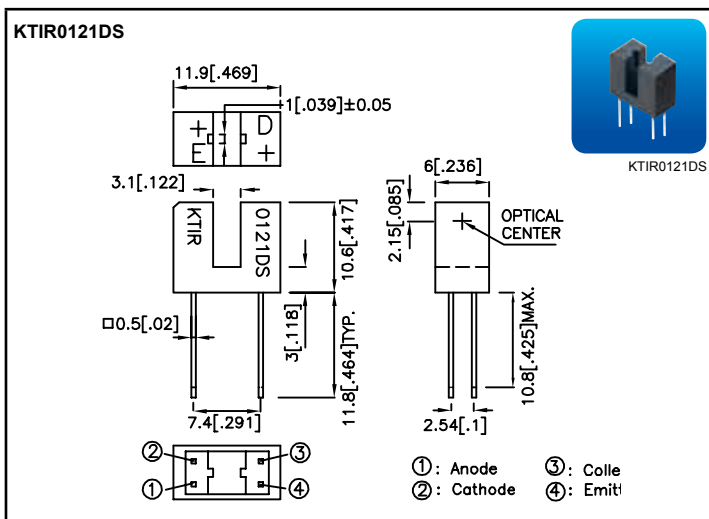
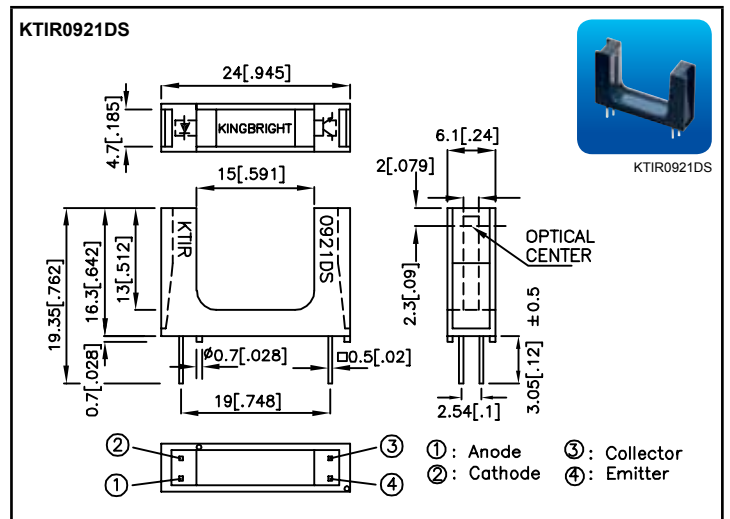
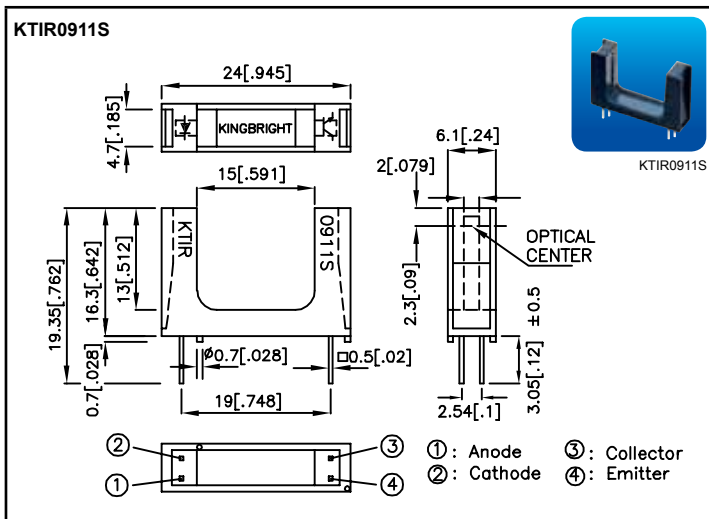

NOTES:

1. All dimensions are in millimeters (inches).
2. Tolerance is $\pm 0.25\text{mm}$ ($0.01''$) unless otherwise noted.

PART NUMBER	PIN CONFIGURATION	MATERIAL	λ_P (nm)	CTR			$V_{CE(SAT)}$			RISE TIME (μs)	FALL TIME (μs)
				IF(mA)	$V_{CE(V)}$	TYP.(%)	IF(mA)	IC(mA)	MAX.(V)	TYP.	TYP.
KRA011		GaAs/SiC	940	5	5	8	10	0.04	0.4	50	50
KRA021		GaAs/SiC	940	10	2	18	20	0.25	0.4	15	15
KRA031		GaAs/SiC	940	5	2	10	10	0.15	0.4	15	15
KRA041		GaAs/SiC	940	5	2	6	10	0.4	0.4	15	15

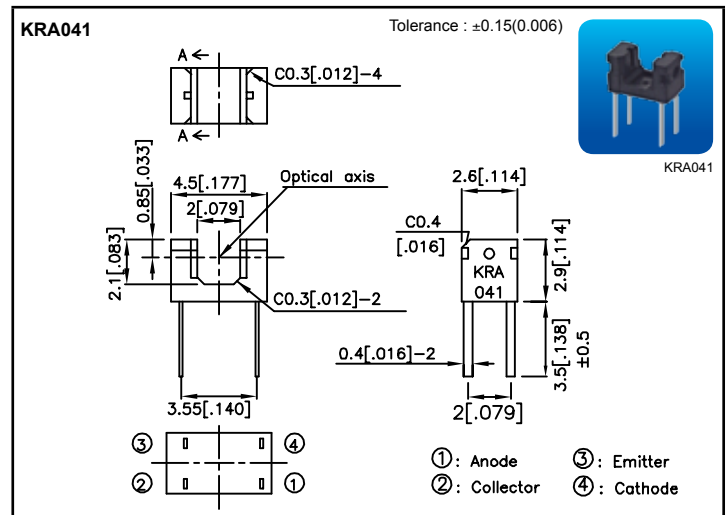
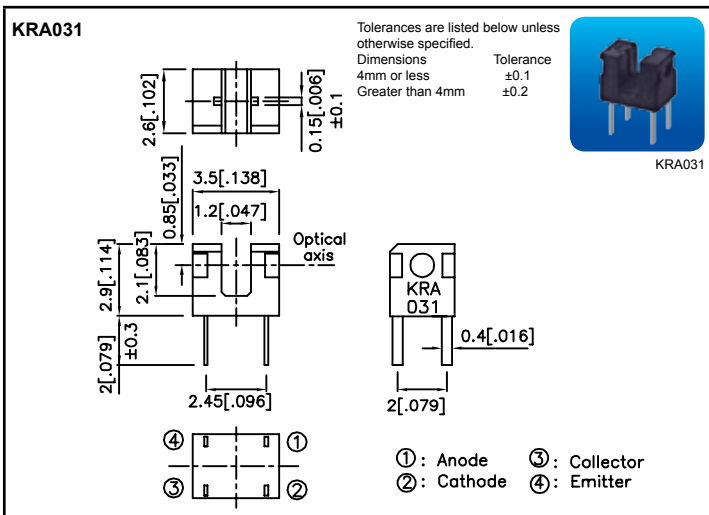
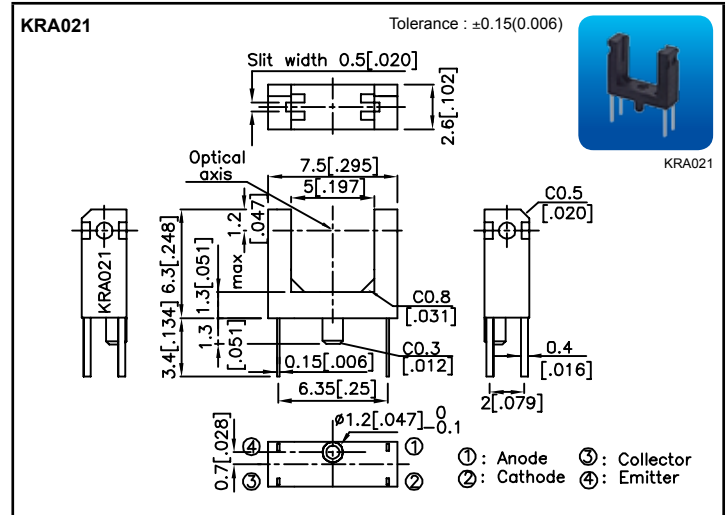
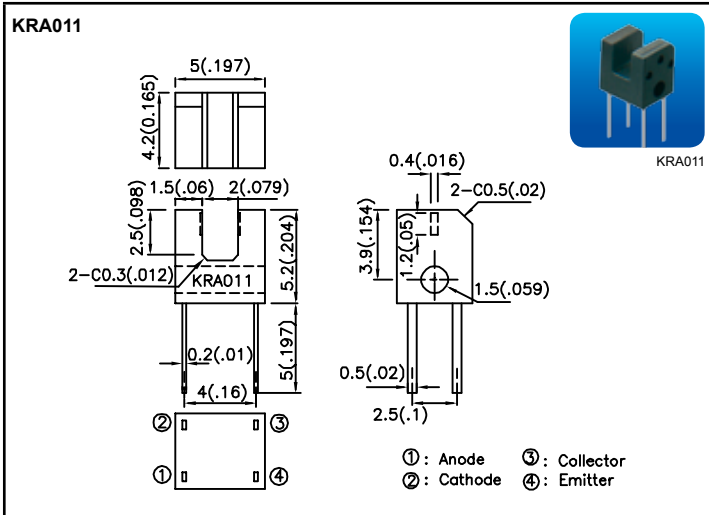

NOTES:
1. All dimensions are in millimeters(inches).
2. Tolerance is $\pm 0.25mm(0.01")$ unless otherwise noted.

PART NUMBER	PIN CONFIGURATION	MATERIAL	λ_P (nm)	CTR			$V_{CE(SAT)}$			RISE TIME (μ s)	FALL TIME (μ s)
				IF(mA)	$V_{CE(V)}$	TYP.(%)	IF(mA)	IC(mA)	MAX.(V)	TYP.	TYP.
KRB011		GaAs/SiC	940	5	5	3	20	0.05	0.4	8	10
KRB021		GaAs/SiC	940	5	5	3	20	0.05	0.4	8	10
KRB031		GaAs/SiC	940	5	5	3	20	0.05	0.4	8	10

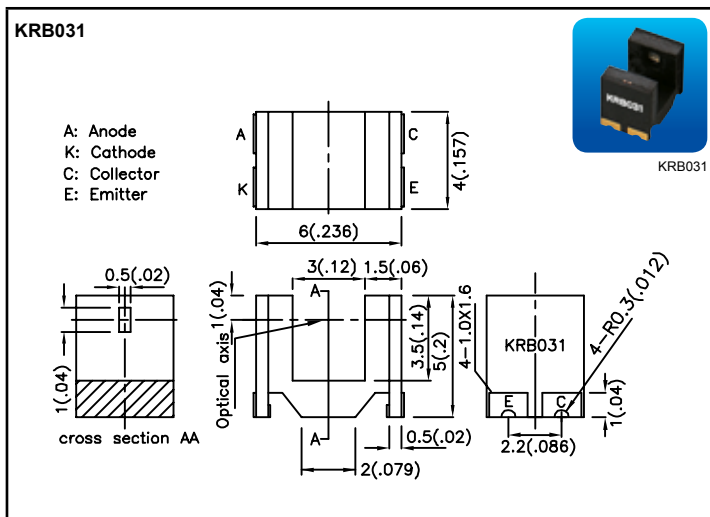
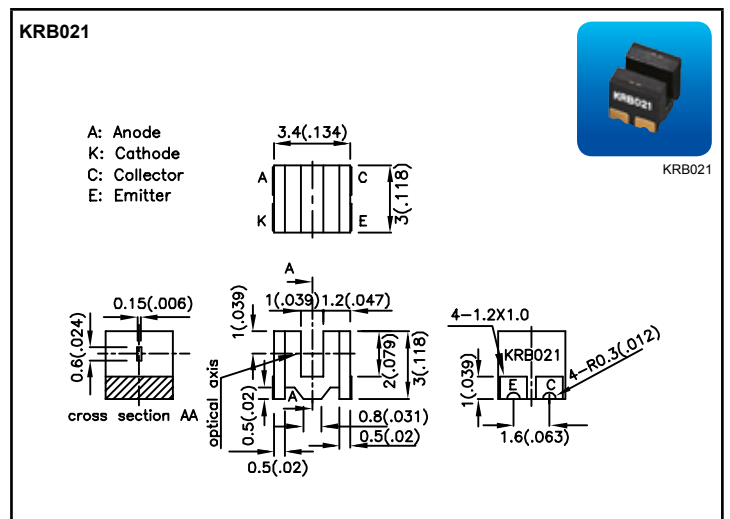
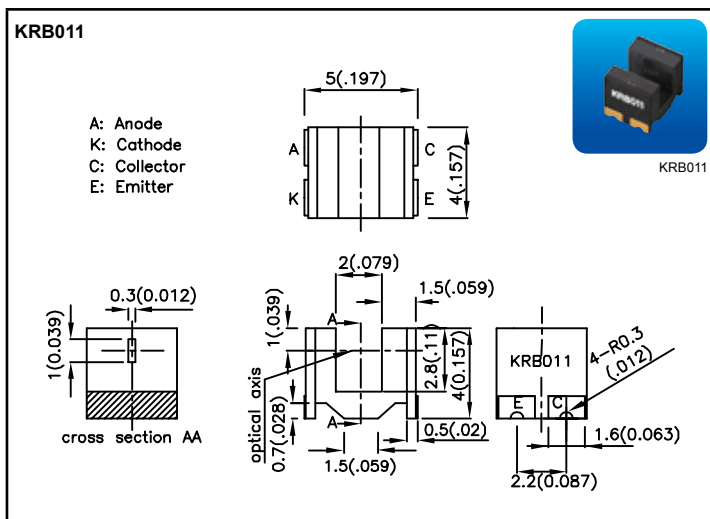

NOTES:
1. All dimensions are in millimeters(inches).
2. Tolerance is $\pm 0.15\text{mm}(0.006\text{'})$ unless otherwise noted.

PART NUMBER	PIN CONFIGURATION	MATERIAL	λ_P (nm)	IC (μ A)			$V_{CE(SAT)}$			RISE TIME (μ s)	FALL TIME (μ s)
				$V_{CE}=2V, I_F=4mA$			IF(mA)	IC(mA)	MAX.(V)	TYP.	TYP.
				MIN.	TYP.	MAX.					
KTIR0711S		GaAs/SiC	● 940	10	-	400	-	-	-	20	20
KTIR0721DS		GaAs/SiC	● 940	-	3000	-	-	-	-	80	70
KTIR0811S		GaAs/SiC	● 940	10	-	400	-	-	-	20	20
KTIR0821DS		GaAs/SiC	● 940	-	3000	-	-	-	-	80	70

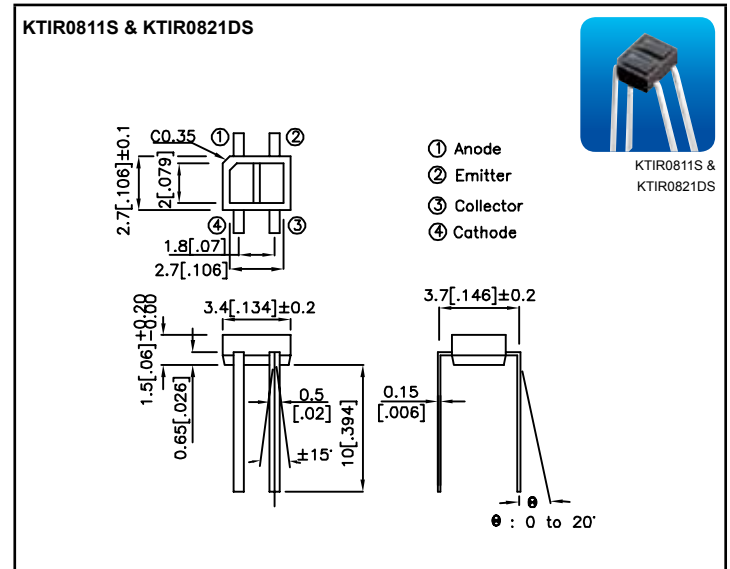
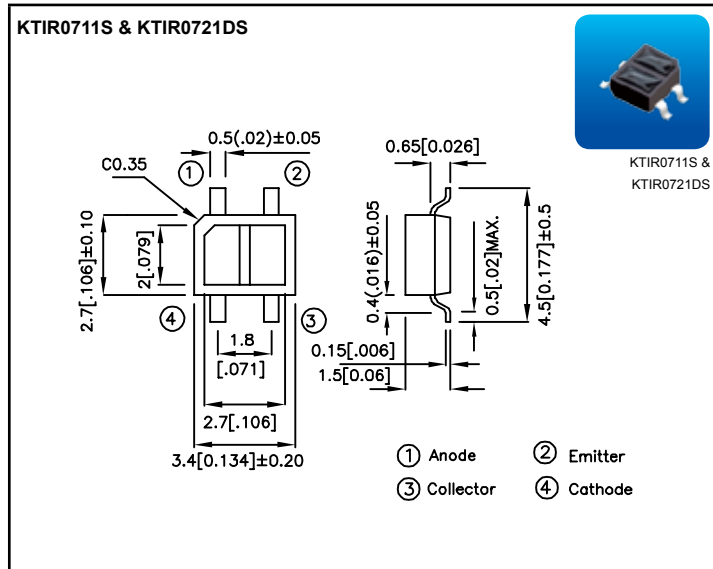

NOTES:
1. All dimensions are in millimeters(inches).
2. Tolerance is ±0.25mm(0.01") unless otherwise noted.

PART NUMBER	PIN CONFIGURATION	MATERIAL	λ_P (nm)	IC (μ A)			V _{CE(SAT)}			RISE TIME (μ s)	FALL TIME (μ s)
				V _{CE} =2V, I _F =4mA			I _F (mA)	I _C (mA)	MAX.(V)	TYP.	TYP.
				MIN.	TYP.	MAX.					
KTIR0A11S		GaAs/SiC	● 940	10	-	400	-	-	-	20	20
KTIR0A21DS		GaAs/SiC	● 940	-	3000	-	-	-	80	70	

PART NUMBER	PIN CONFIGURATION	MATERIAL	λ_P (nm)	IC (μ A)			V _{CE(SAT)}			RISE TIME (μ s)	FALL TIME (μ s)
				V _{CE} =5V, I _F =20mA			I _F (mA)	I _C (mA)	Max.(V)	Typ.	Typ.
				MIN.	TYP.	MAX.					
KRC011		GaAs/SiC	● 940	10	-	300	-	-	20	20	

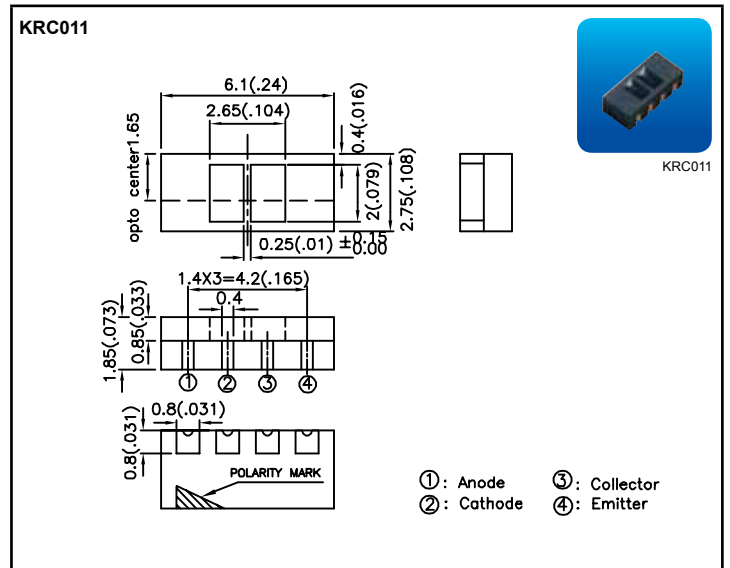
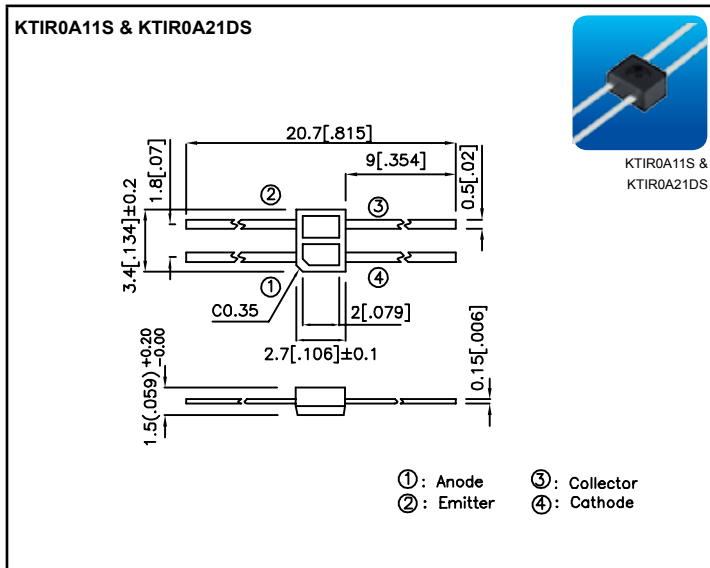

NOTES:
 1. All dimensions are in millimeters(inches).
 2. Tolerance is $\pm 0.25\text{mm}(0.01\text{''})$ unless otherwise noted.

Kingbright

Optoelectronic Components



SMD Tape Specifications

106

SMT Reflow Soldering Instructions

Reflow Soldering Profile For Lead-free SMT Process.

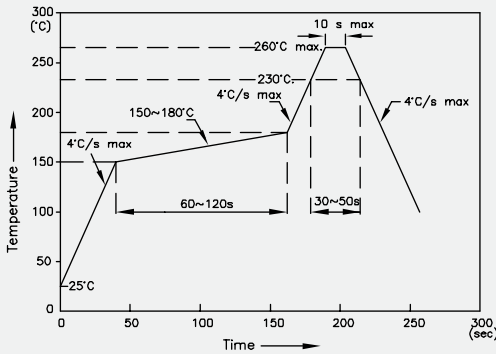

NOTES:

1. We recommend the reflow temperature 245°C(+/-5°C). The maximum soldering temperature should be limited to 260°C.
2. Don't cause stress to the epoxy resin while it is exposed to high temperature.
3. Number of reflow process shall be 2 times or less.

PART NUMBER	REEL DIMENSIONS
KPHHS-1005, KP-1608, KPT-1608, KPTD-1608, KP-2012, KPT-2012, KPTC-2012, KPHCM-2012, KP-23, KP-3216, KPT-3216, KPC-3216, KPTR-3216, KPA-1606, KPA-2106, KPJA-2107, KPA-3010, KPA-3210, KPL-3015, KPTL-3216, KPTD-3216, KPD-3224, KPTB-1612, KPTB-1615, KPBVA-3010, KPB-3025, KPBL-3025, KPBD-3224, , KM-23, KPHBM-2012, KA-2810A, KA-2214, KA-3021, KT-2117, KT-2520, KT-3020, KT-3228	7" (for 8mm width tape)
KA-2735, KA-3022-4.5SF, KA-3528, KA-3529, KA-3535, KA-4040, KA-4008, KAAF-5060, KM2520xxx03, KM2520xxx08, KM2520xxx09, KM-27xxx-03, KM-27xxx-09, KT-3535, KT-5050, KT-5051, KPED-3528, KPED-3820	7" (for 12mm width tape)
KTDG-9072	13" (for 16mm width tape)
KAD1-1010, KAD1-9090, KA-8080, KADG1-8080, KA-8070, KADS-8070, KCSX02, KCDX02, KCSX03, KCDX03, KCSX04	13" (for 24mm width tape)
KCDX04, KCPDX04, KCPSX04, KCSX56	13" (for 32mm width tape)
KCDX56	13" (for 44mm width tape)
KAAF5051	15" (for 16mm width tape)

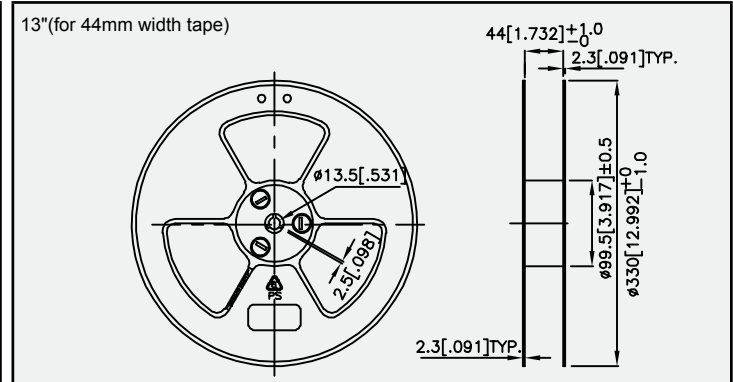
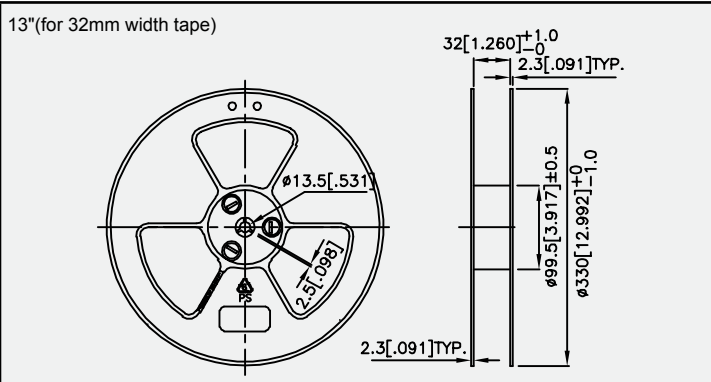
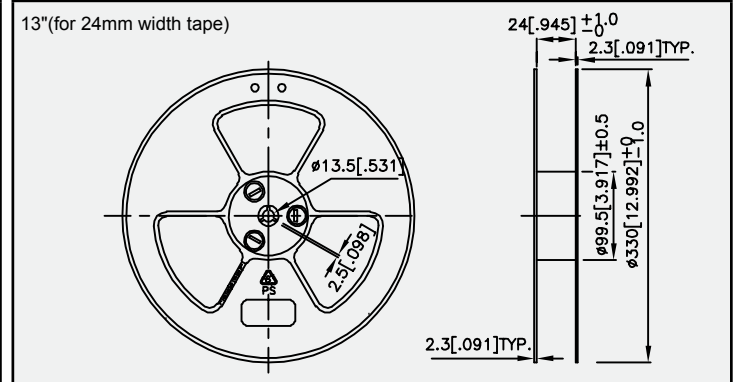
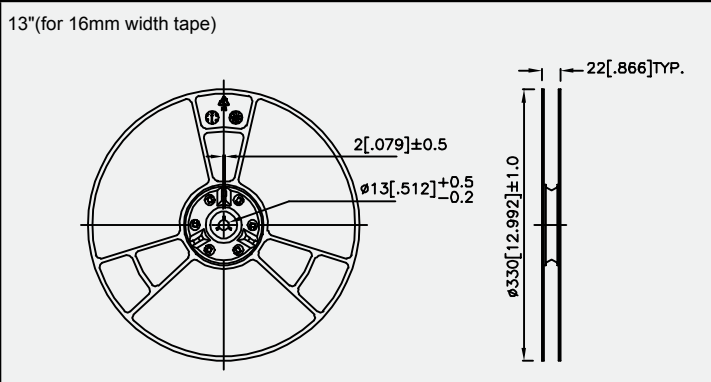
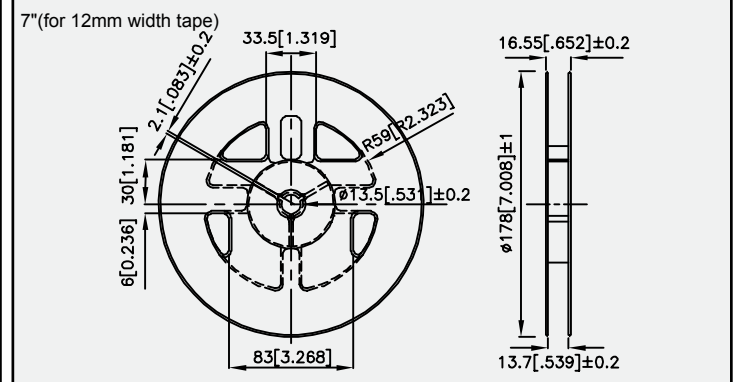
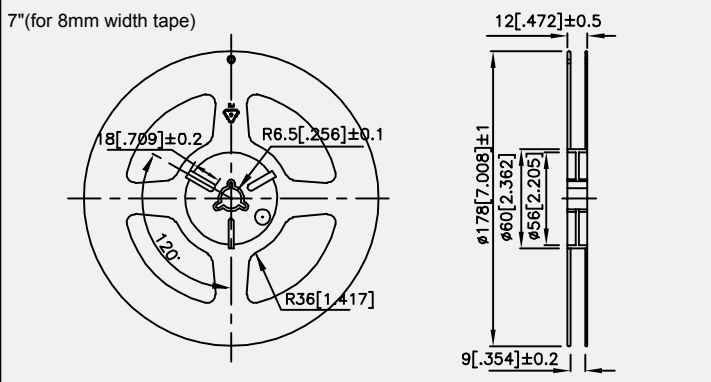

NOTE: 1. All dimensions are in millimeters(inches).

15" (for 16mm width tape)

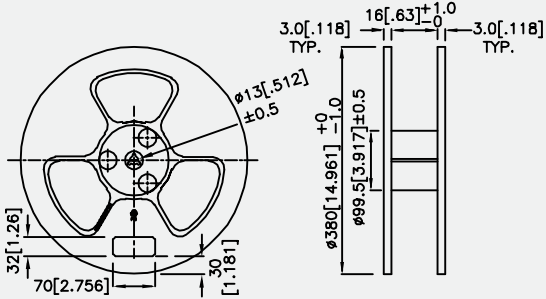

KA-3529

PACKAGE: 1500PCS / REEL

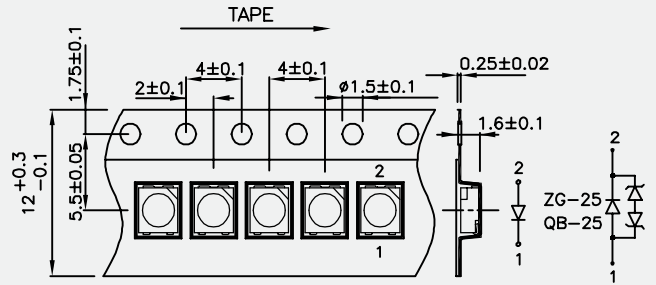

KA-3535

PACKAGE: 2000PCS / REEL

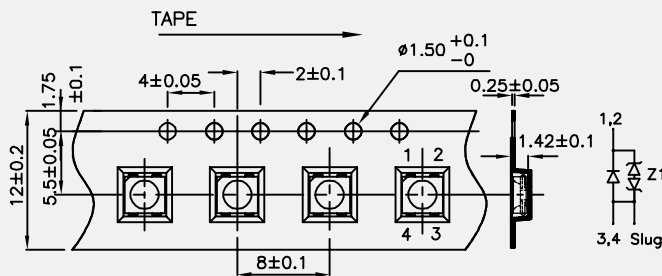

KAD1-9090

PACKAGE: 500PCS / REEL

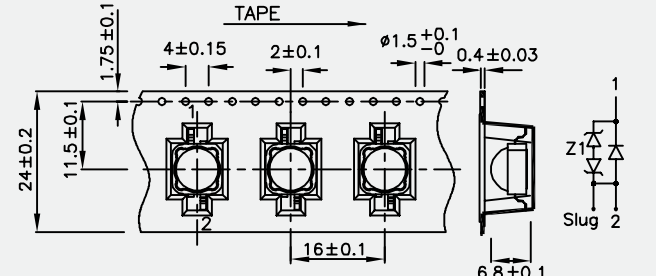

KAD1-1010

PACKAGE: 300PCS / REEL

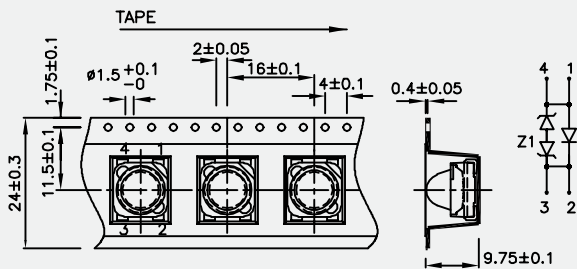

KA-8070

PACKAGE: 500PCS / REEL

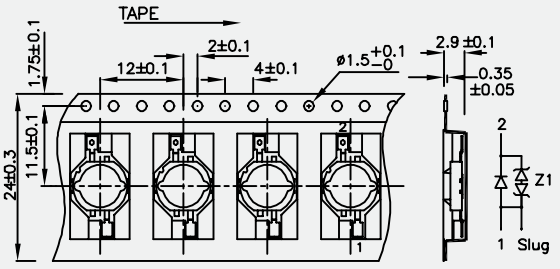

KADS-8070

PACKAGE: 500PCS / REEL

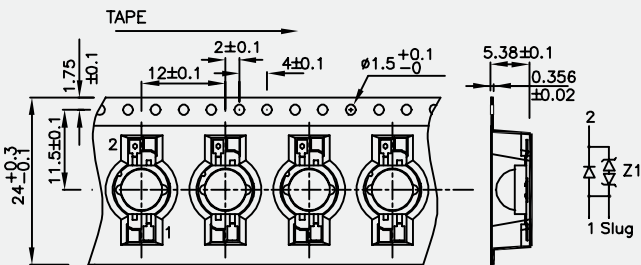

KA-8080

PACKAGE: 500PCS / REEL

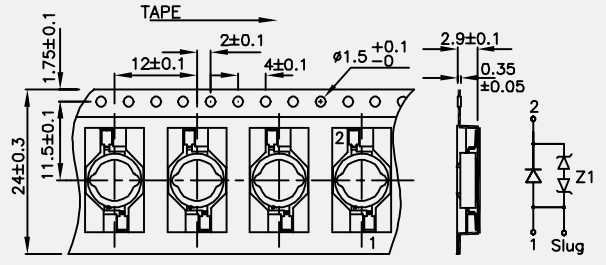

KADG1-8080

PACKAGE: 500PCS / REEL

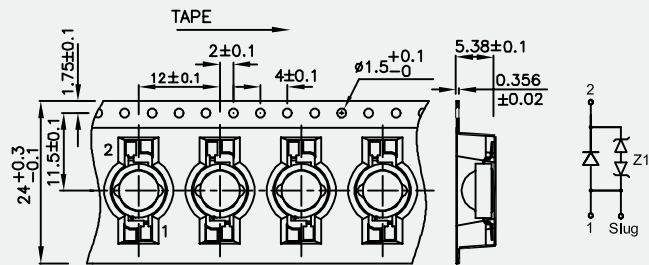

KT-2117

PACKAGE: 2000PCS / REEL

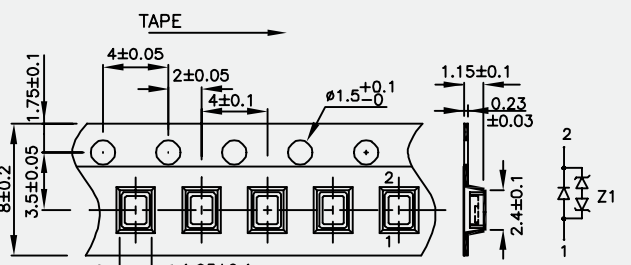

NOTE: 1. All dimensions are in millimeters.

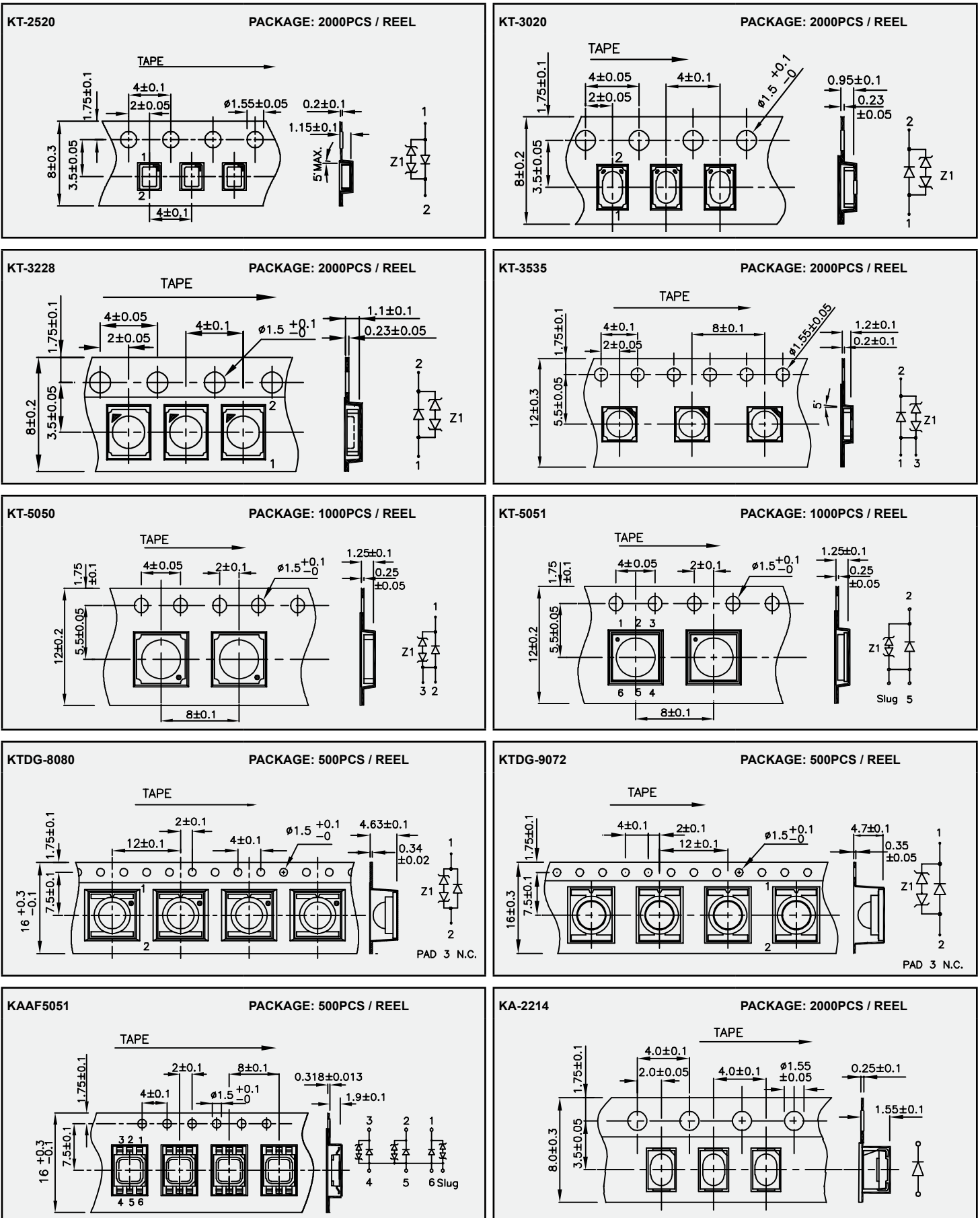

NOTE: 1. All dimensions are in millimeters.

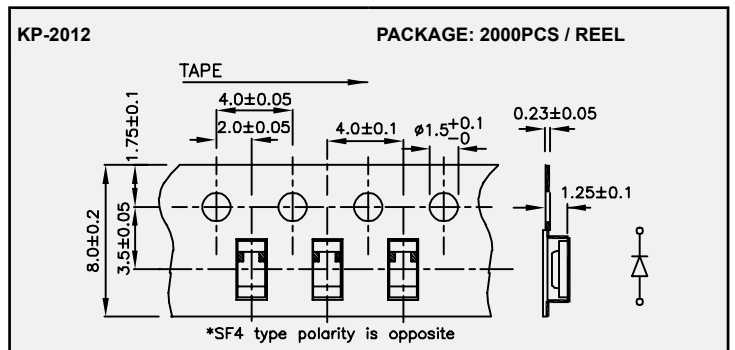
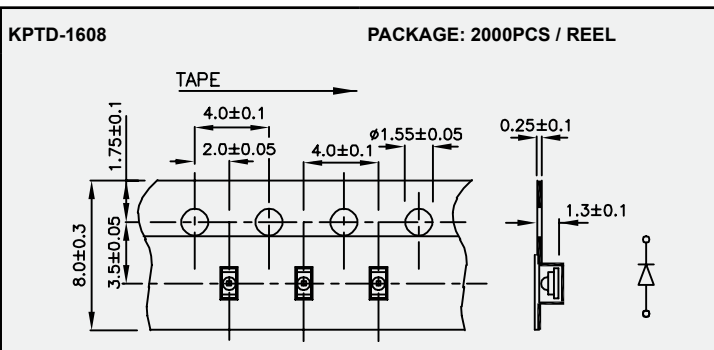
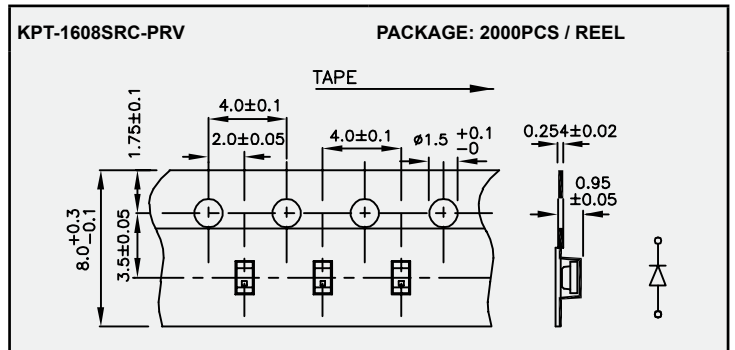
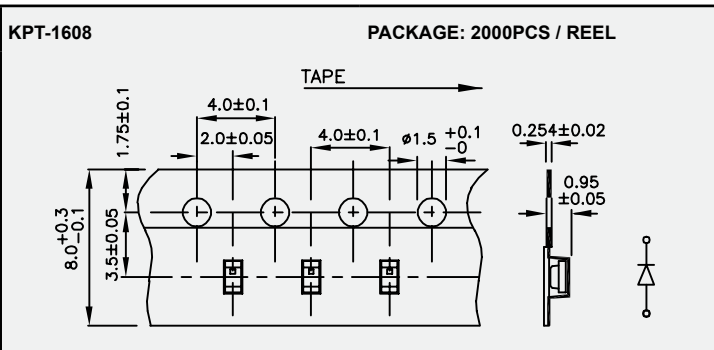
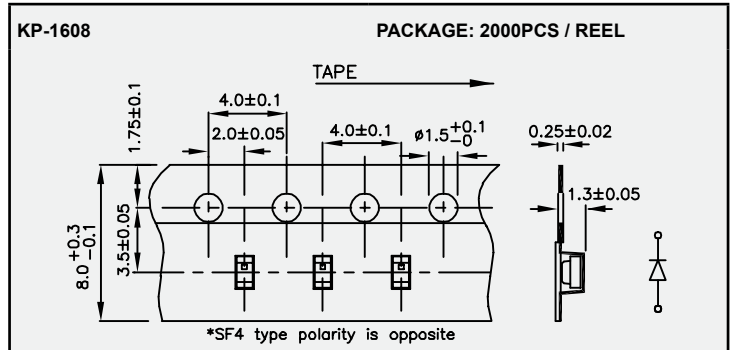
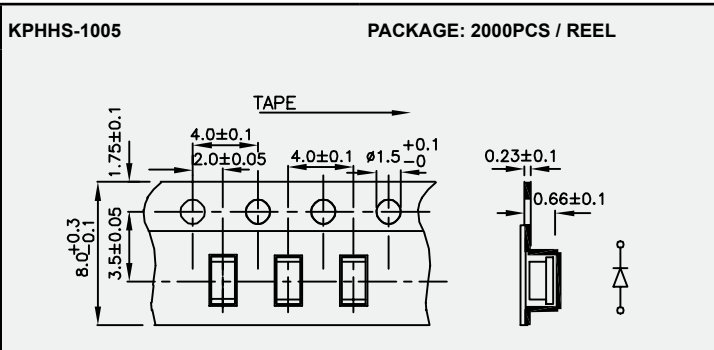
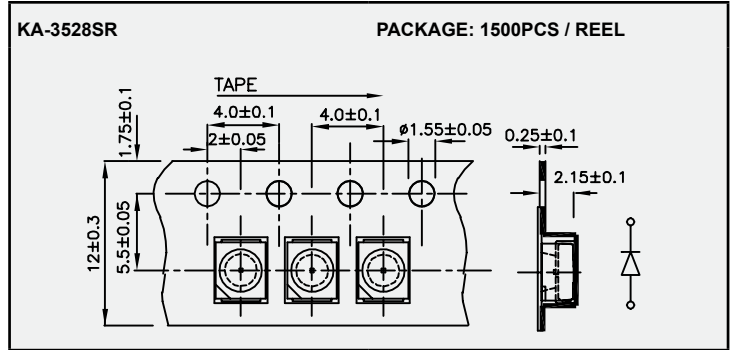
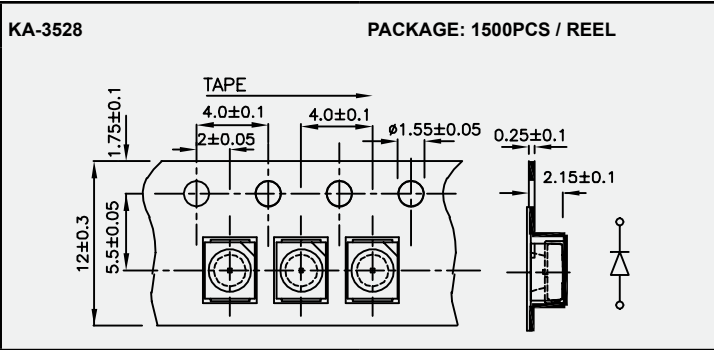
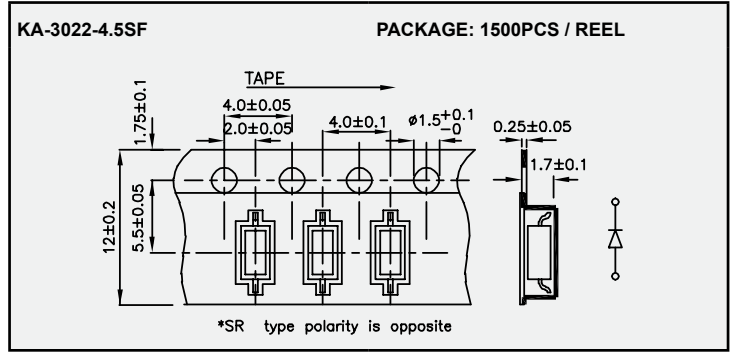
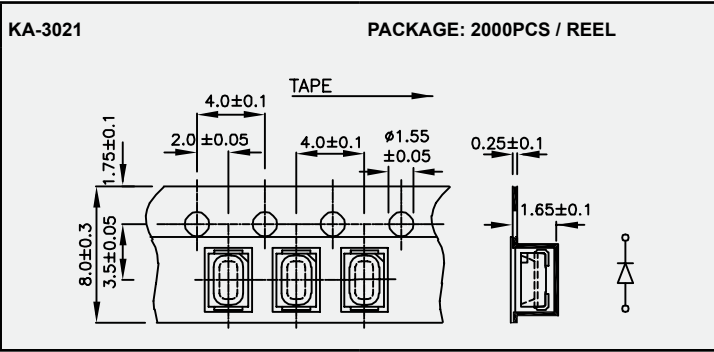

NOTE: 1. All dimensions are in millimeters.

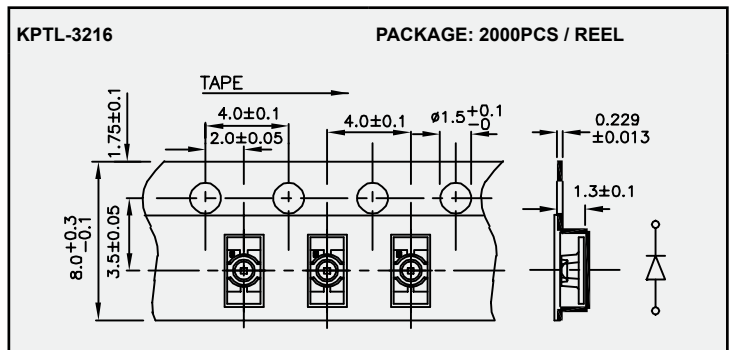
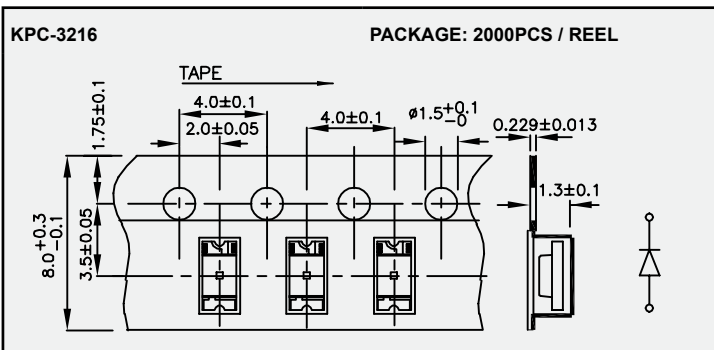
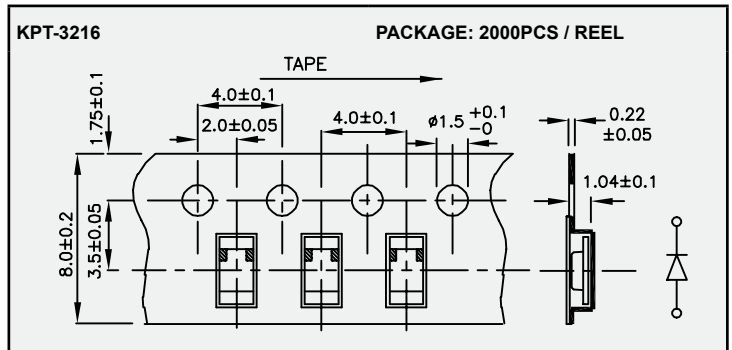
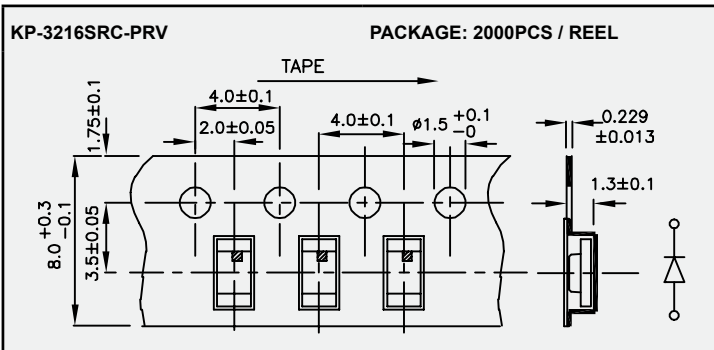
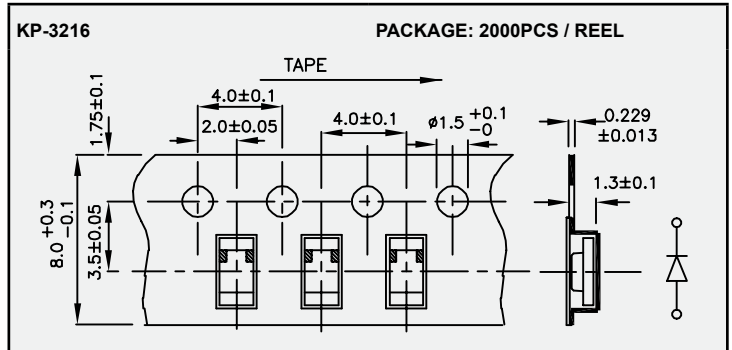
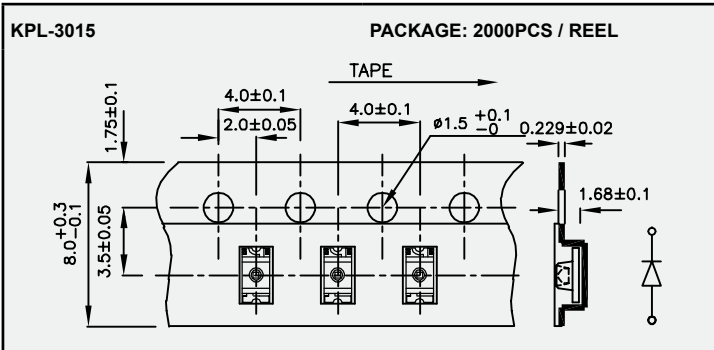
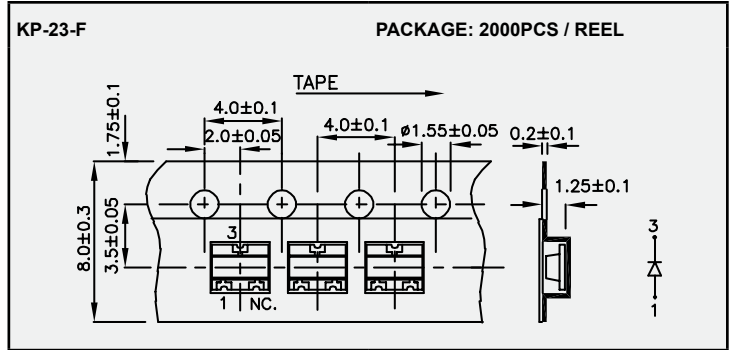
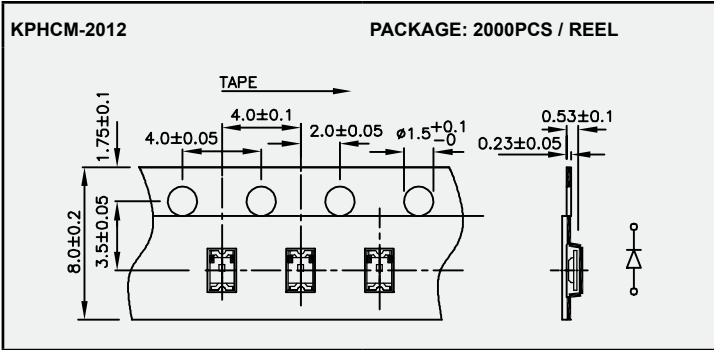
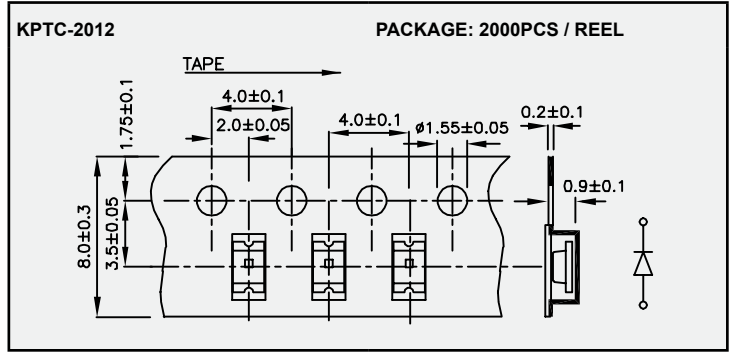
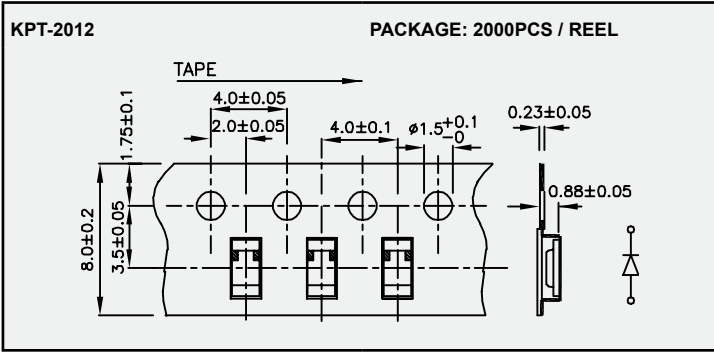

NOTE: 1. All dimensions are in millimeters.

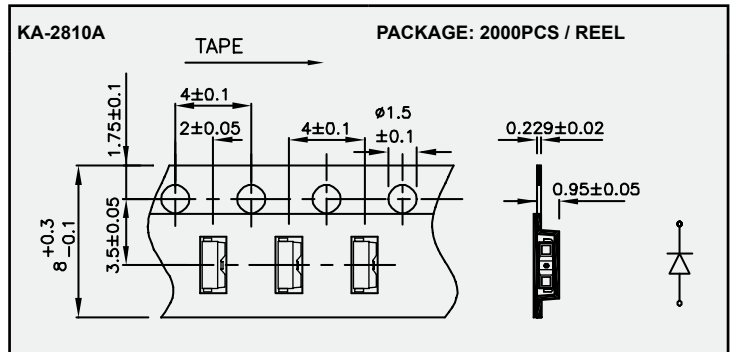
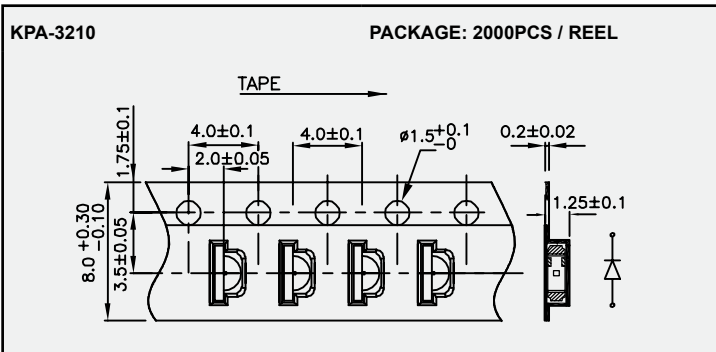
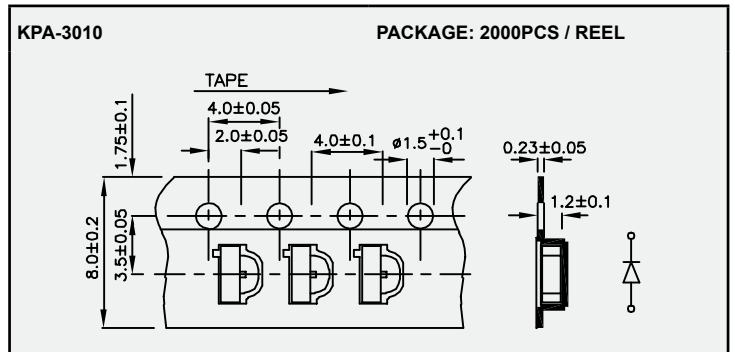
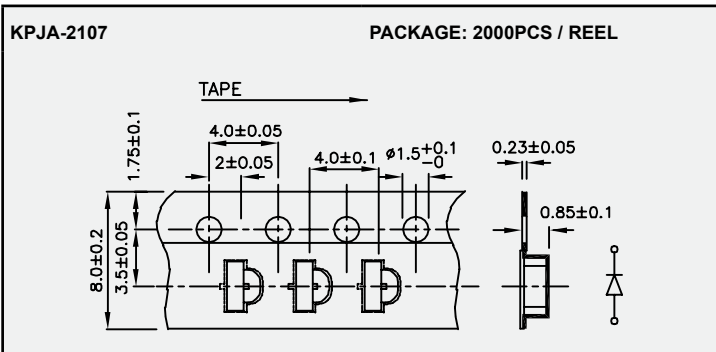
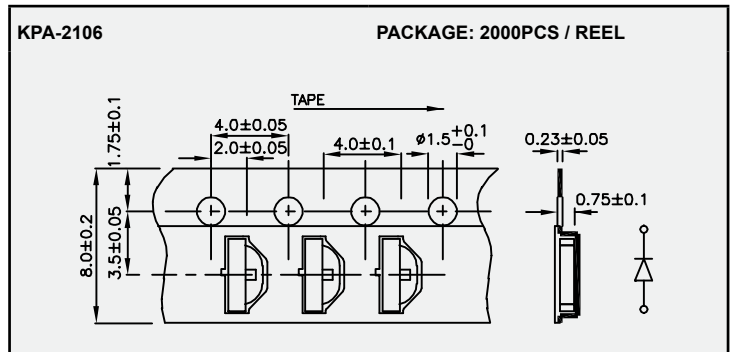
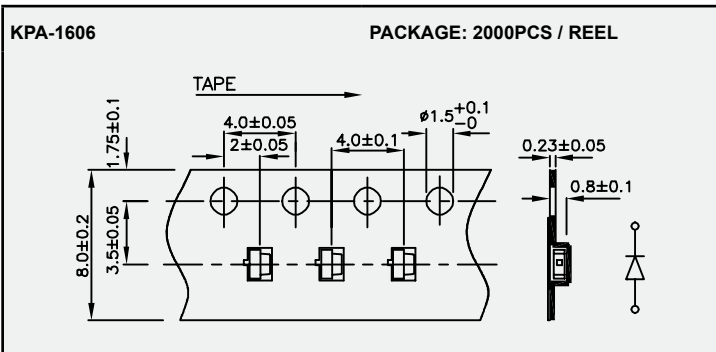
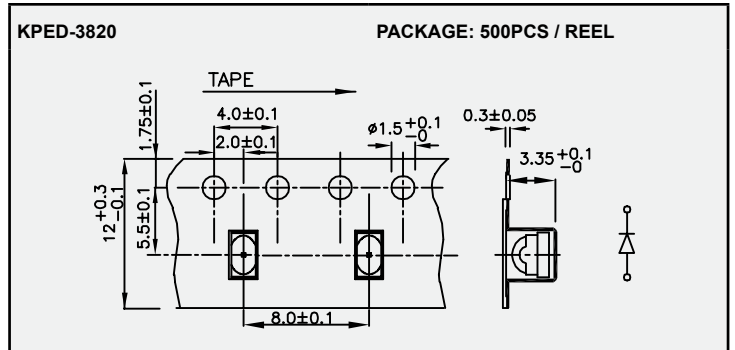
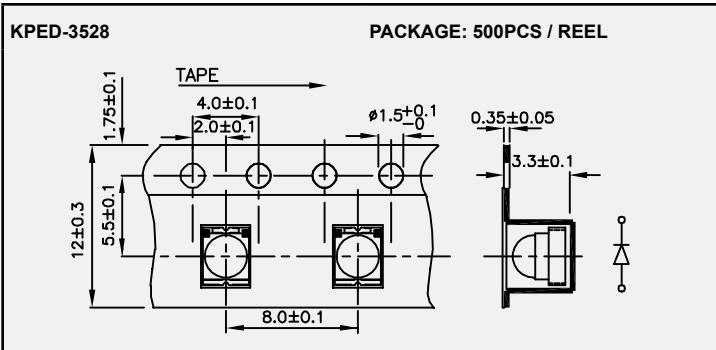
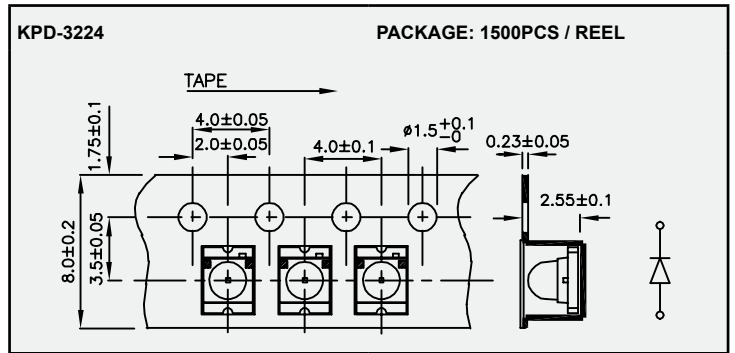
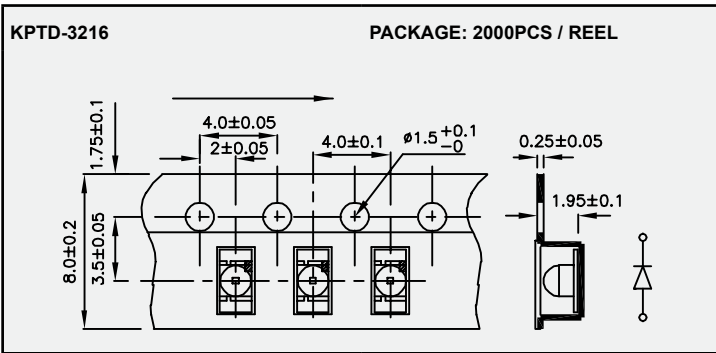

NOTE: 1. All dimensions are in millimeters.

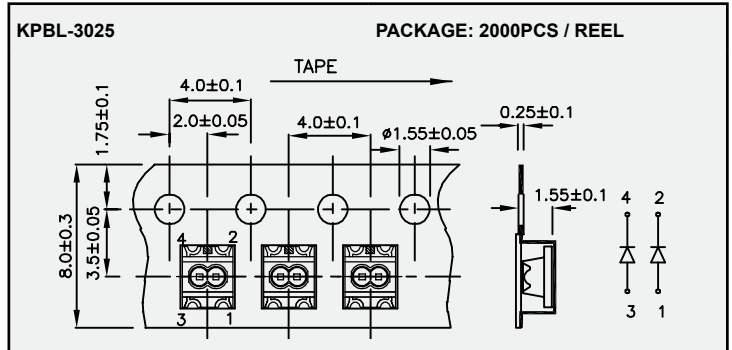
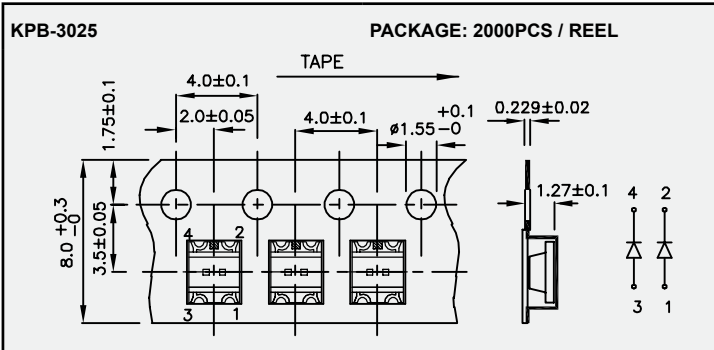
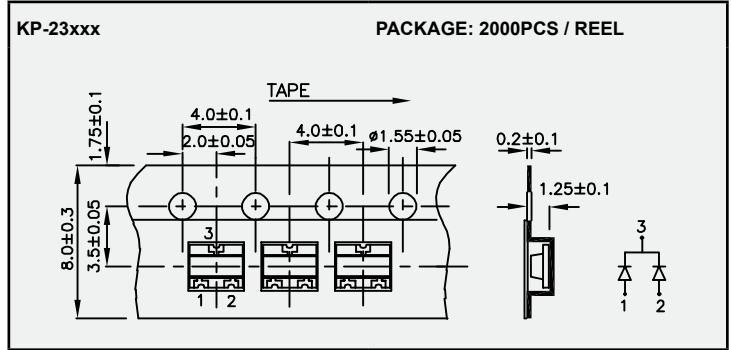
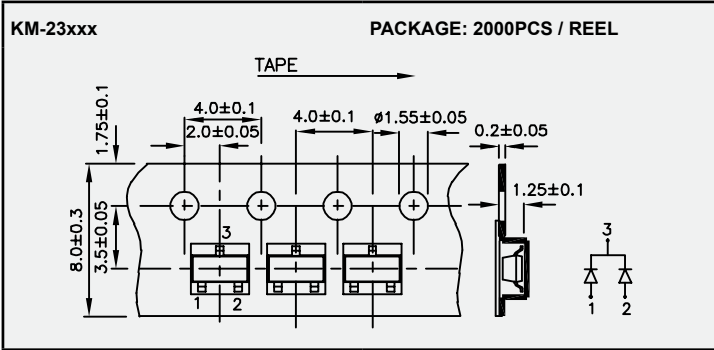
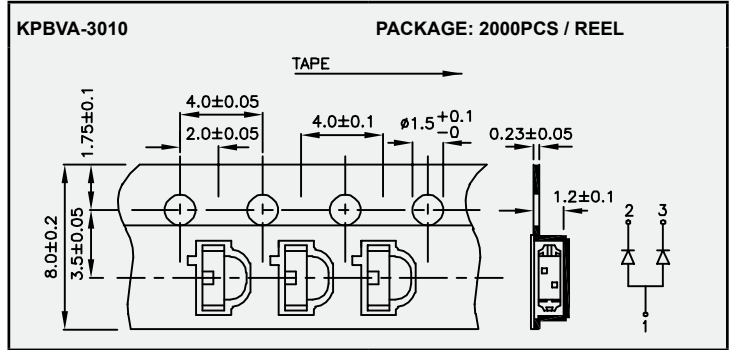
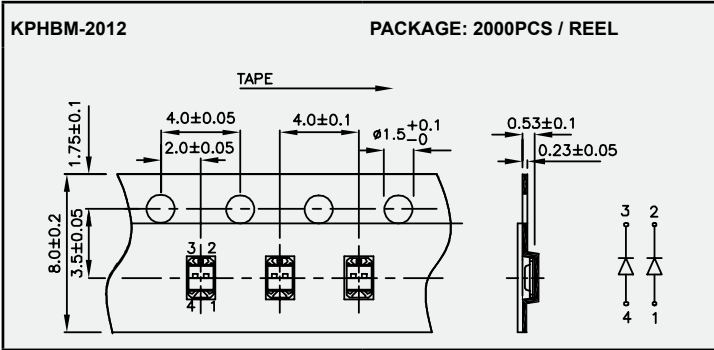
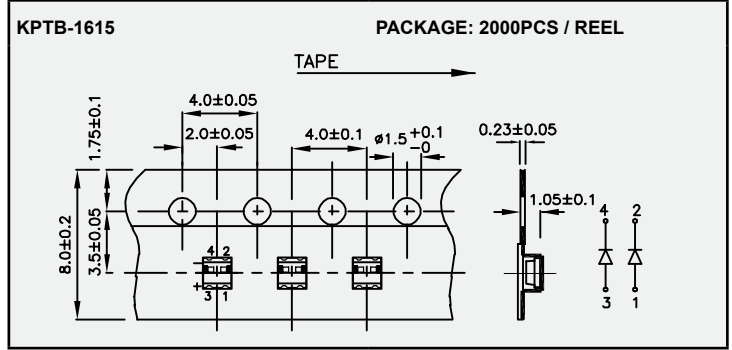
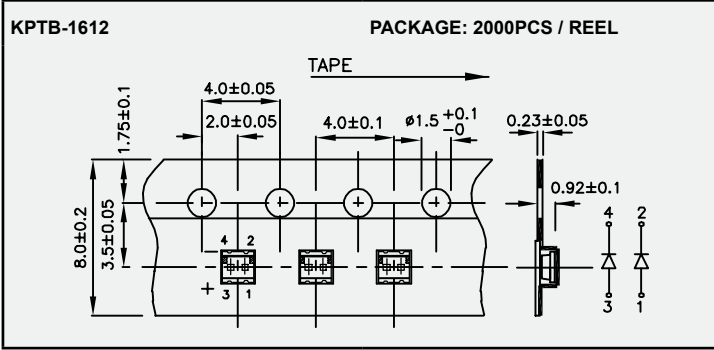
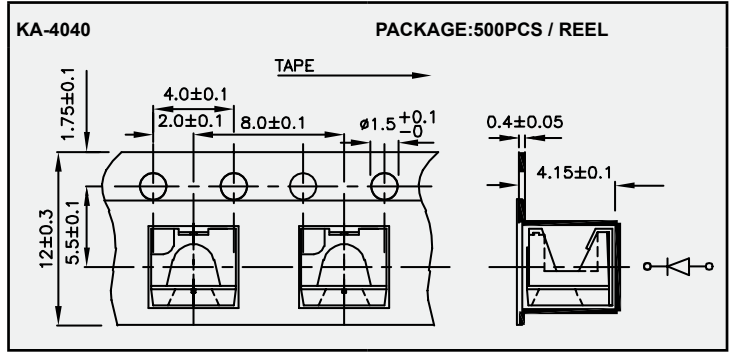
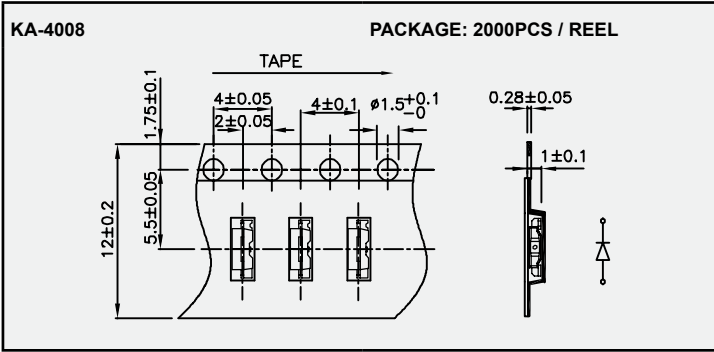

NOTE: 1. All dimensions are in millimeters.

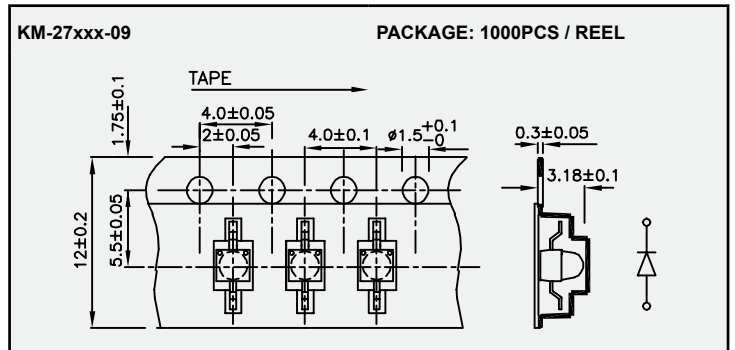
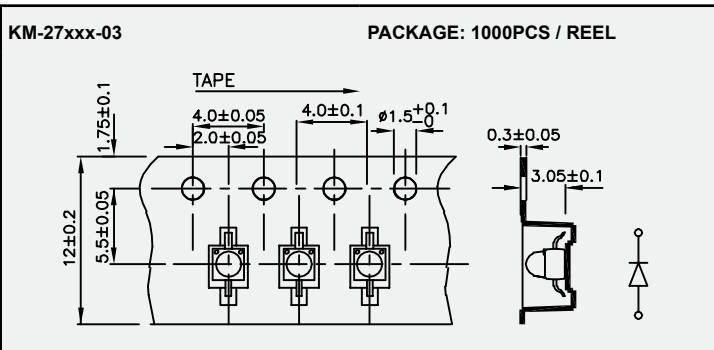
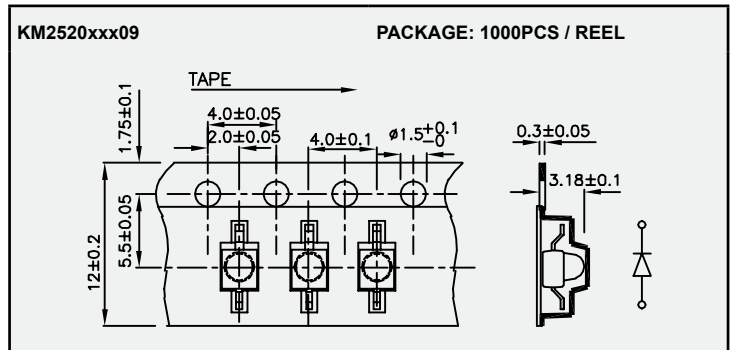
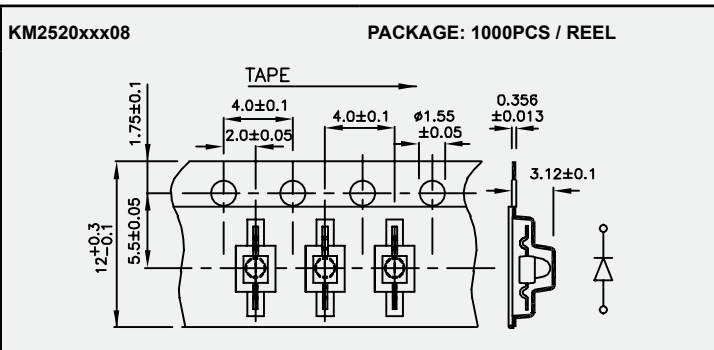
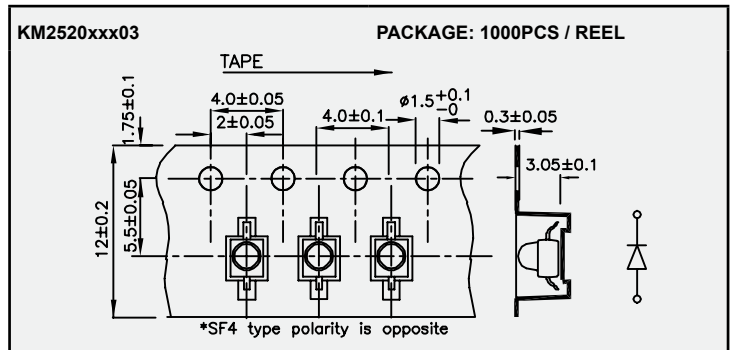
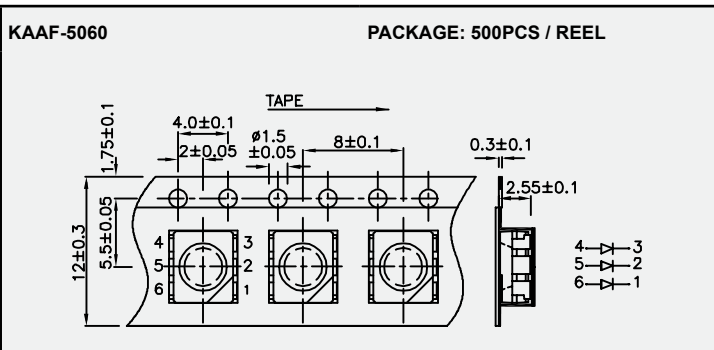
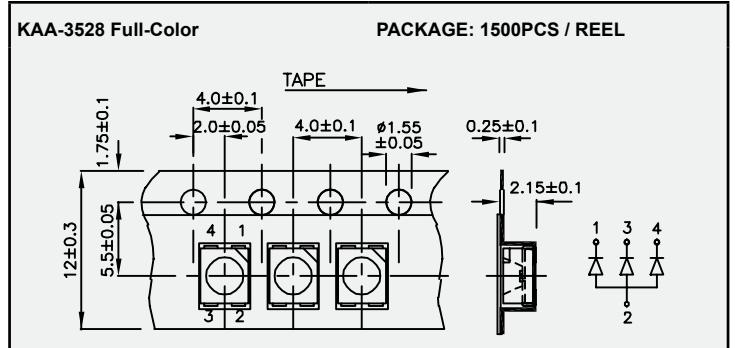
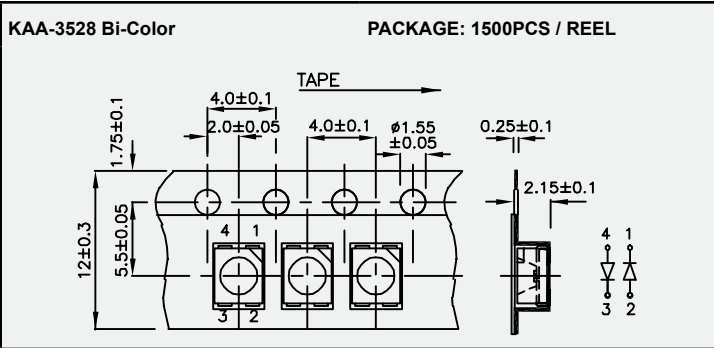
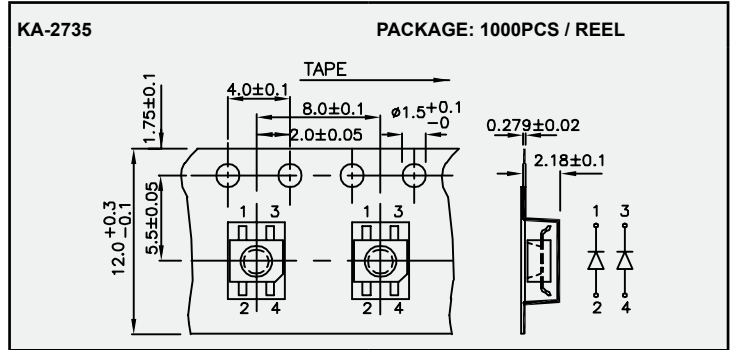
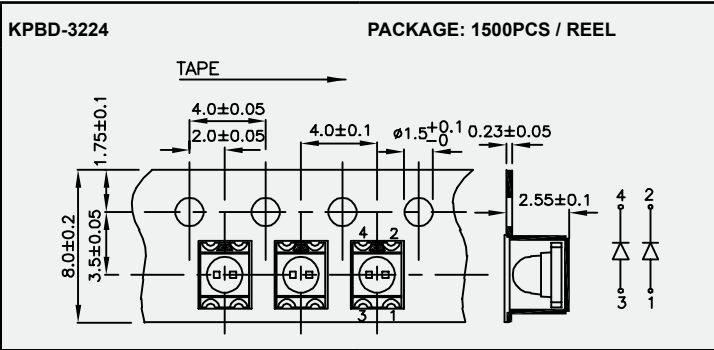

NOTE: 1. All dimensions are in millimeters.

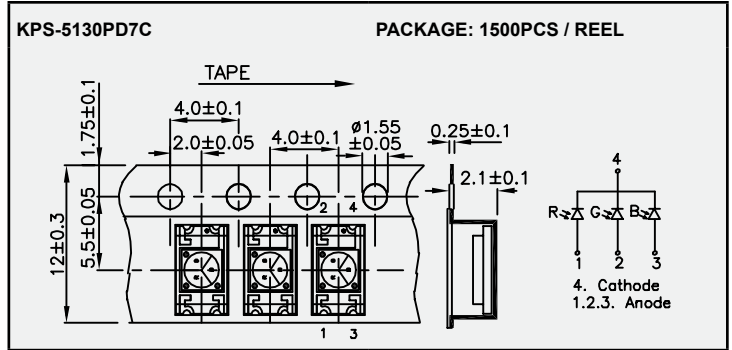
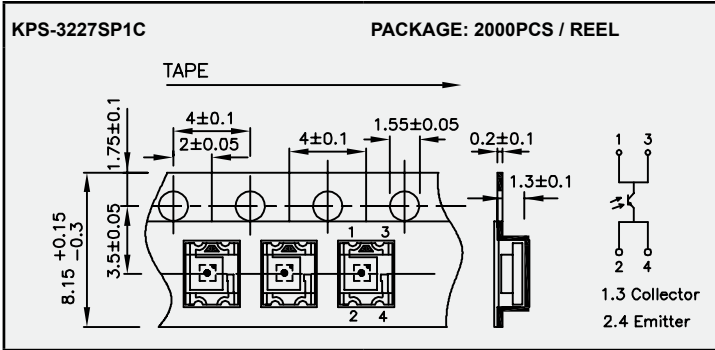
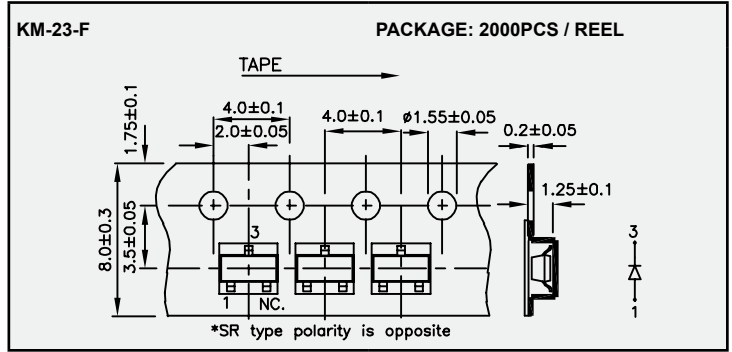
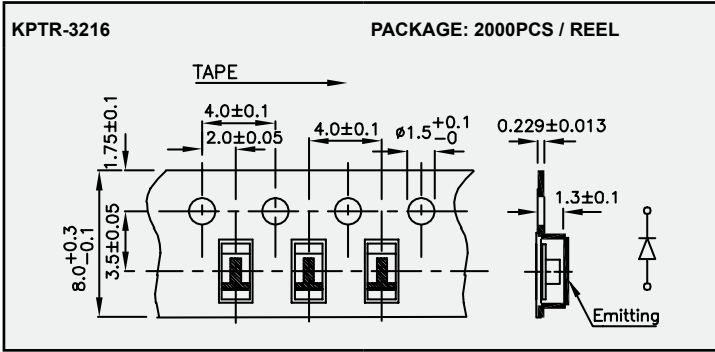

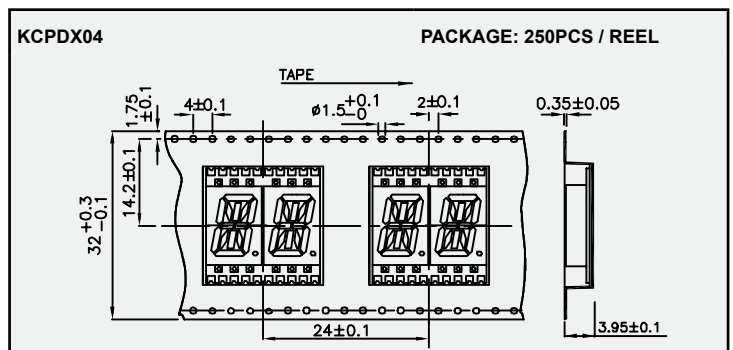
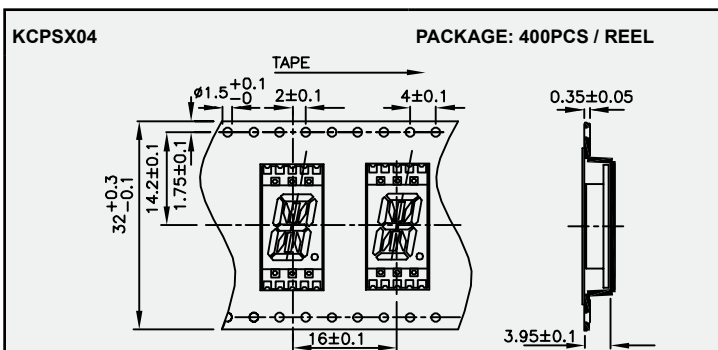
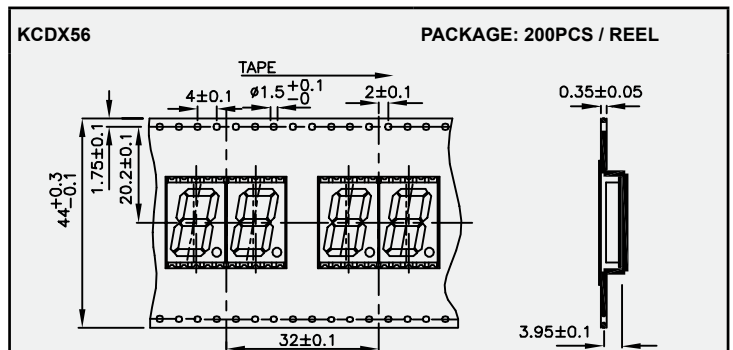
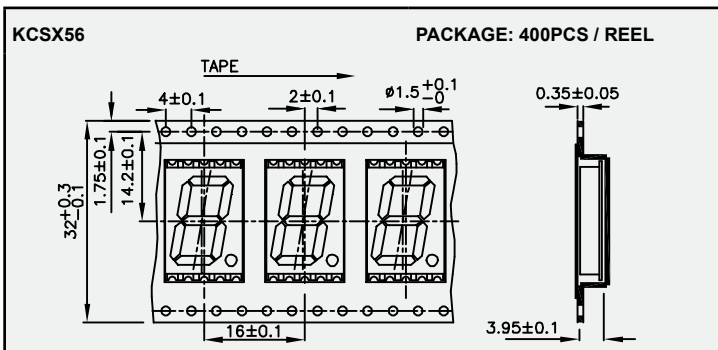
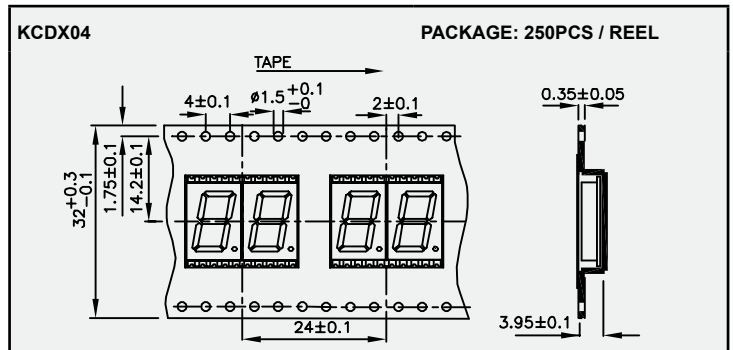
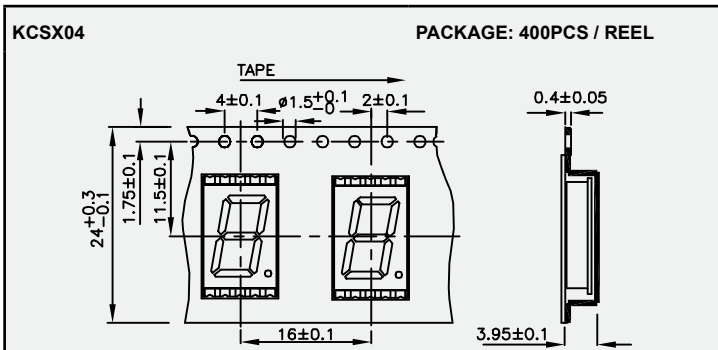
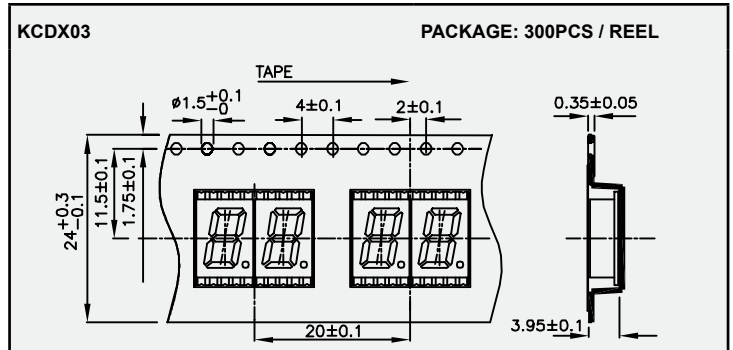
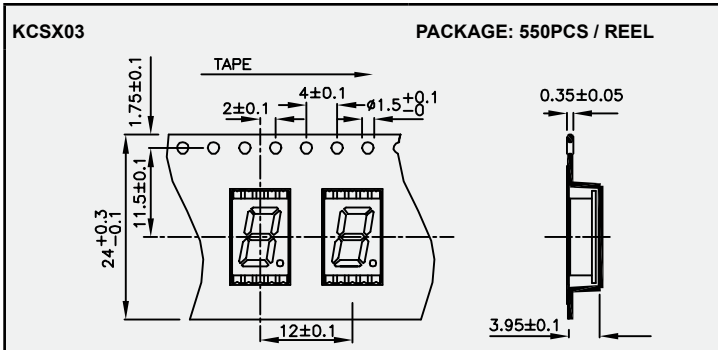
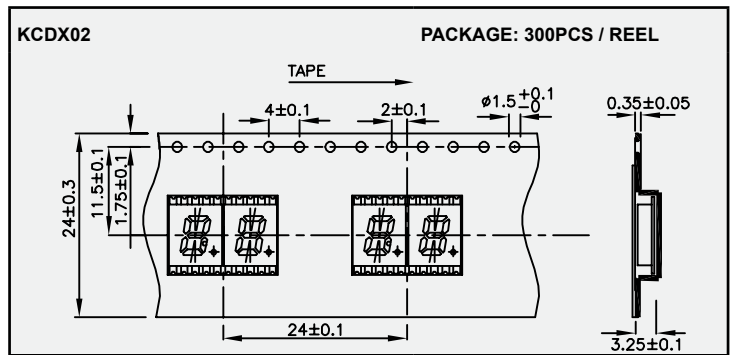
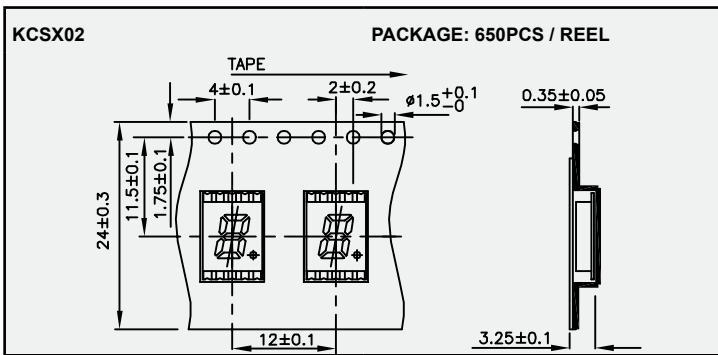

NOTE: 1. All dimensions are in millimeters.

Kingbright

Optoelectronic Components



Recommended Soldering Pattern 116

KA-3529

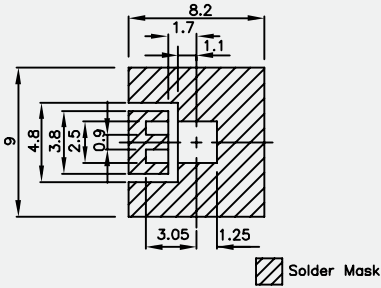

KA-3535

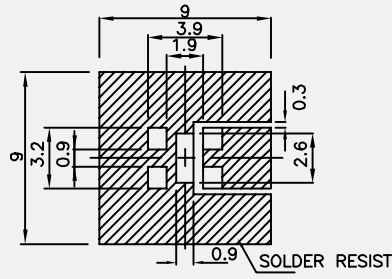

KAD1-9090

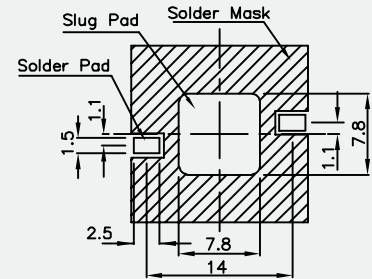

KAD1-1010

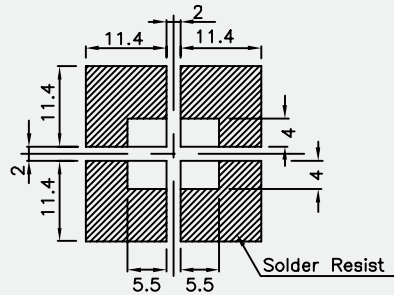

KA-8070, KADS-8070

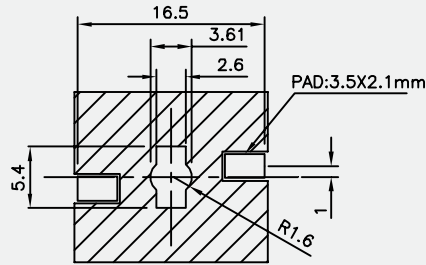

KA-8080, KADG1-8080

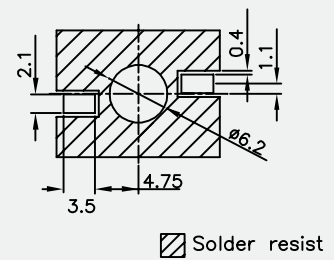

KT-2117

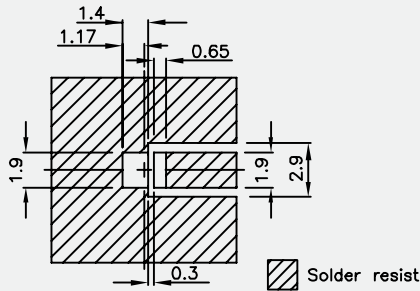

KT-2520

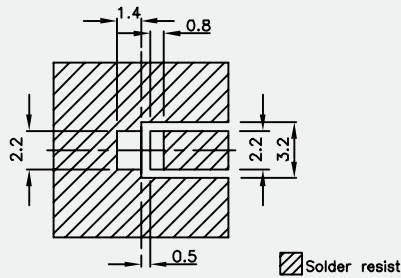

KT-3020

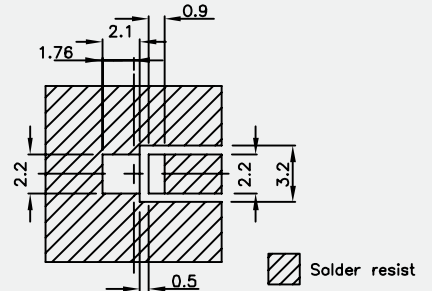

KT-3228

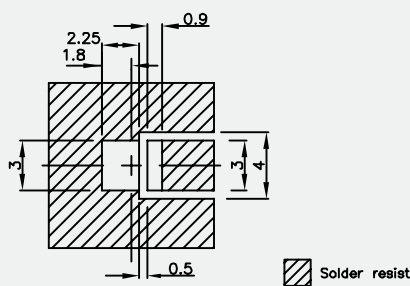

KT-3535

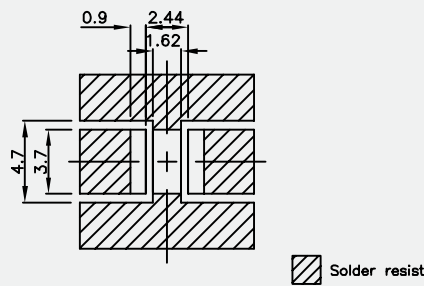

KT-5050

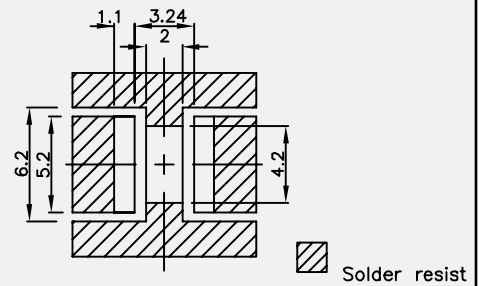

KT-5051

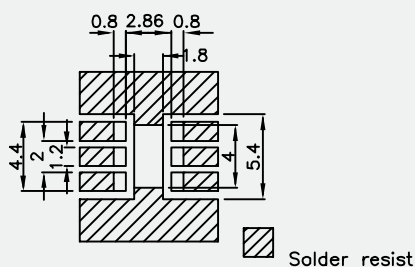

KTDG-8080

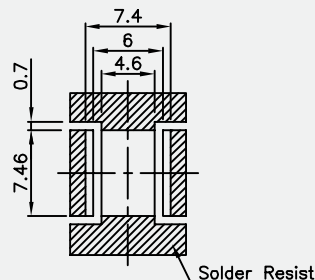

KTDG-9072

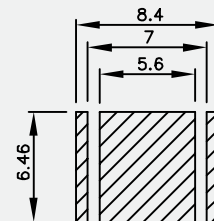

NOTES:

1. All dimensions are in millimeters.
2. Tolerance is ± 0.1 mm unless otherwise noted.

<p>KAAF5051</p>	<p>KA-2214</p>	<p>KA-3021</p>
<p>KA-3022-4.5SF</p>	<p>KA-3528 , KPED-3528</p>	<p>KPHHS-1005</p>
<p>KP-1608, KPT-1608, KPTD-1608</p>	<p>KP-2012, KPT-2012, KPTC-2012</p>	<p>KPHCM-2012</p>
<p>KP-23-F, KP-23xxx</p>	<p>KPL-3015</p>	<p>KP-3216, KPT-3216, KPC-3216, KPTD-3216</p>
<p>KPTL-3216</p>	<p>KPD-3224</p>	<p>KPED-3820</p>

NOTES:
 1. All dimensions are in millimeters.
 2. Tolerance is ± 0.1 mm unless otherwise noted.

KPA-1606

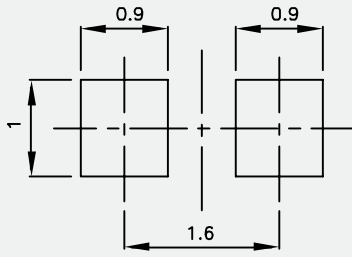

KPA-2106

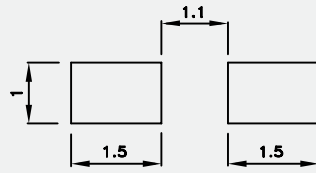

KPJA-2107

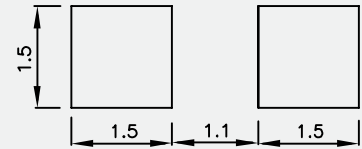

KPA-3010, KPBVA-3010

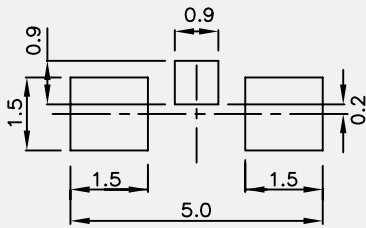

KPA-3210

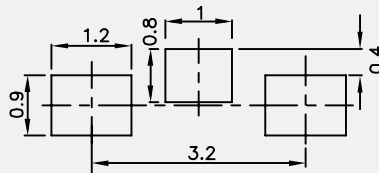

KA-2810A

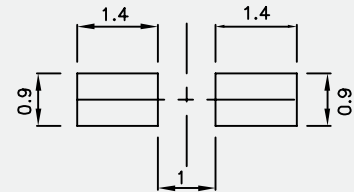

KA-4008

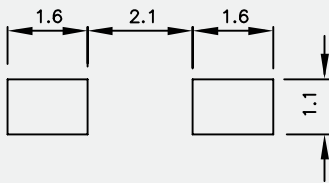

KA-4040

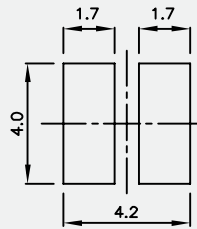

KPTB-1612

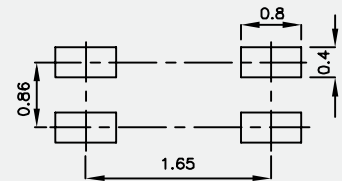

KPTB-1615

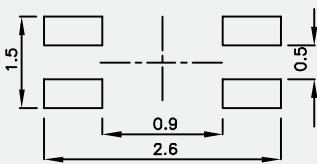

KPHBM-2012

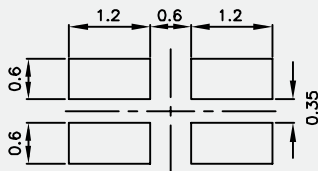

KM-23-F, KM-23xxx

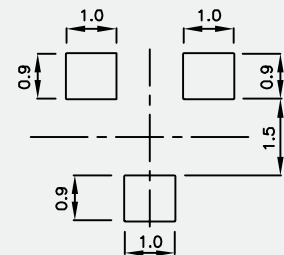

KPB-3025, KPBL-3025

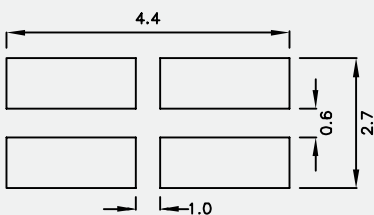

KPBD-3224

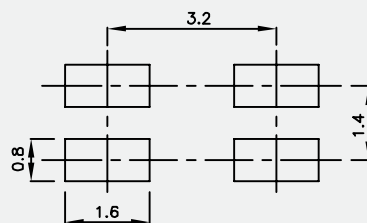

KA-2735

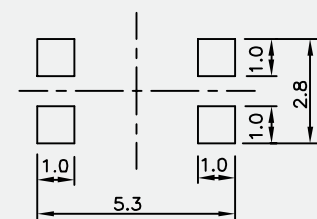

- NOTES:
 1. All dimensions are in millimeters.
 2. Tolerance is ± 0.1 mm unless otherwise noted.

KAA-3528

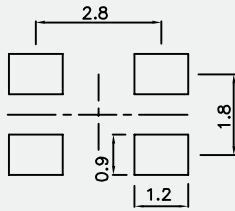

KAAF-5060

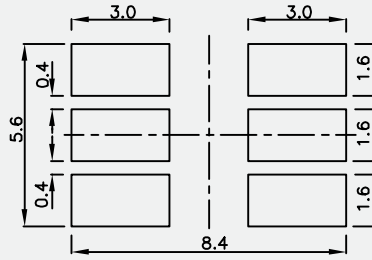

KM2520xxx03, KM-27xxx-03

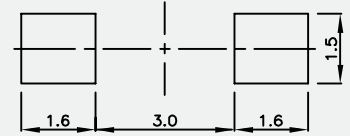

KM2520xxx08

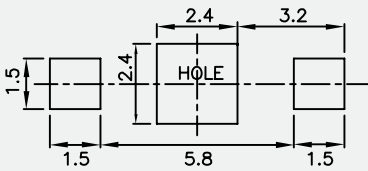

KM2520xxx09, KM-27xxx-09

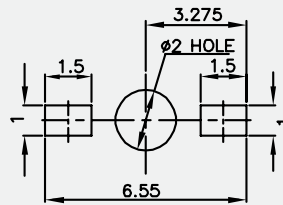

KPTR-3216

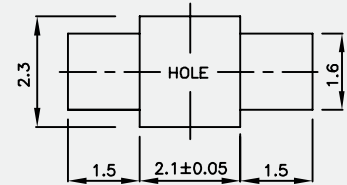

KPS-3227SP1C

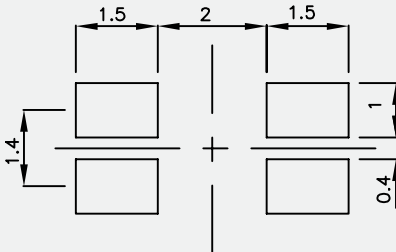

KPS-5130PD7C

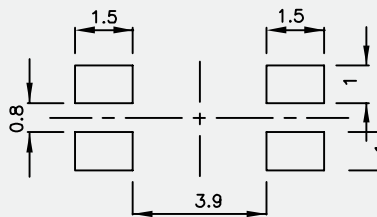

NOTES:

1. All dimensions are in millimeters.
2. Tolerance is ± 0.1 mm unless otherwise noted.

KCSX02

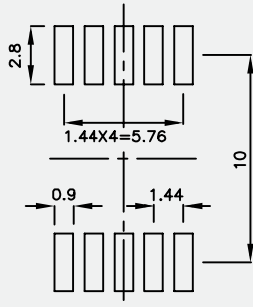

KCDX02

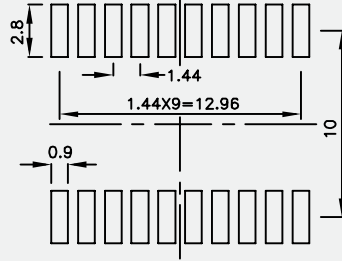

KCSX03

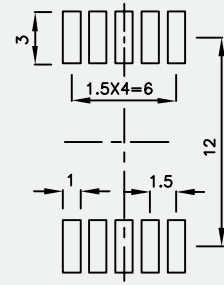

KCDX03

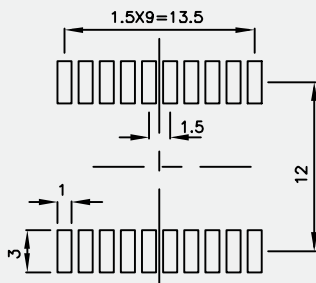

KCSX04

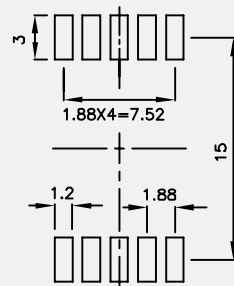

KCDX04

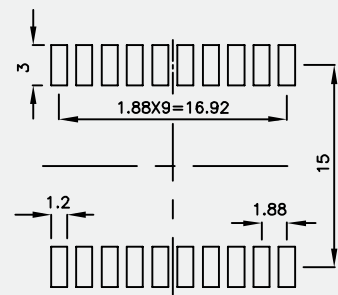

KCSX56

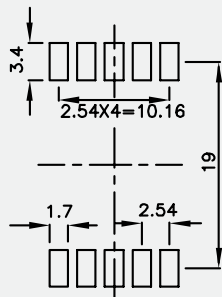

KCDX56

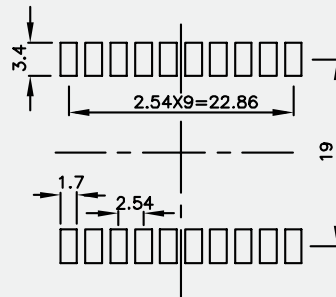

KCPSX04

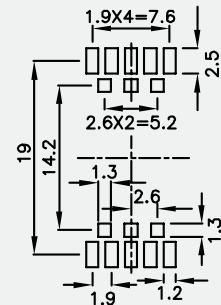

KCPDX04

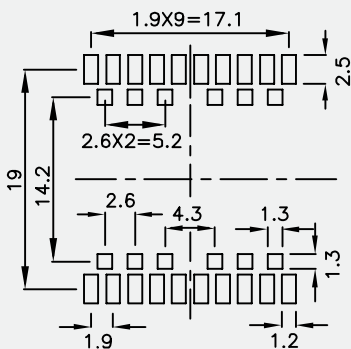

NOTES:

1. All dimensions are in millimeters.
2. Tolerance is ± 0.15 mm unless otherwise noted.

Kingbright

Optoelectronic Components



Technical Data **121**

Bin Code Systems **133**

Absolute maximum ratings (T _A =25°C)		E,I Hi.Eff.Red Orange	H Bright Red	SR Super Bright Red	SURK Hyper Red	SUR-E Hyper Red	SUR-G Hyper Red	N Pure Orange	SEK Super Bright Orange	Unit
		(GaAsP/GaP)	(GaP)	(GaAlAs)	(AlGaInP)	(AlGaInP)	(AlGaInP)	(AlGaInP)	(GaAsP/GaP)	(AlGaInP)
Reverse voltage	V _R	●	●	●	●	●	●	●	●	V
Forward current	I _F	5	5	5	5	5	5	5	5	mA
Forward current (Peak) 1/10 Duty Cycle, 0.1ms Pulse Width	I _{FS}	30	25	30	30	30	30	25	30	mA
Power dissipation	P _D	160	130	155	185	200	150	145	195	mW
LED LAMPS:										
Operating temperature	T _A	75	62.5	75	75	75	75	62.5	75	°C
Storage temperature	T _{STG}	-40~+85	-40~+85	-40~+85	-40~+85	-40~+85	-40~+85	-40~+85	-40~+85	°C
LED DISPLAYS:										
Operating temperature	T _A	-40~+85	-40~+85	-40~+85	-40~+85	-40~+85	-40~+85	-40~+85	-40~+85	°C
Storage temperature	T _{STG}	-40~+85	-40~+85	-40~+85	-40~+85	-40~+85	-40~+85	-40~+85	-40~+85	°C

Operating Characteristics		E,I Hi.Eff.Red Orange	H Bright Red	SR Super Bright Red	SURK Hyper Red	SUR-E Hyper Red	SUR-G Hyper Red	N Pure Orange	SEK Super Bright Orange	Unit
		(GaAsP/GaP)	(GaP)	(GaAlAs)	(AlGaInP)	(AlGaInP)	(AlGaInP)	(AlGaInP)	(GaAsP/GaP)	(AlGaInP)
Forward voltage (typ.) I _F =20mA	V _F	●	●	●	●	●	●	●	●	V
I _F =10mA		2.0	2.25	1.85	1.95	1.9	1.9	2.05	2.1	
I _F =2mA		1.9	2.05	1.8	1.85	1.8	1.85	1.95	2.0	
Forward voltage (max.) I _F =20mA, 10mA, 2mA	V _F	1.7	1.85	1.65	1.75	1.7	1.75	1.85	1.85	
Reverse current V _R =5V	I _R	2.5	2.5	2.5	2.5	2.5	2.5	2.5	2.5	V
Peak Emission Wavelength I _F =20mA, 10mA, 2mA	λ _p	10	10	10	10	10	10	10	10	uA
Dominant Wavelength I _F =20mA, 10mA, 2mA	λ _D	627	700	660	650	640	640	607	610	nm
Spectral line half-width I _F =20mA, 10mA, 2mA	Δλ _{1/2}	625	660	640	630	630	630	610	601	nm
Capacitance V _F =0V, f=1MHZ	C	45	45	20	28	25	22	35	29	nm
		15	40	45	35	45	45	15	15	pF

Absolute maximum ratings (T _A =25°C)		SE-E Hyper Red	SE-H Hyper Red	G,SG Green, Super Bright Green	PG Pure Green	CGK Green	MGK Mega Green	MG Mega Green	ZG Green	Unit
		(AlGaInP)	(AlGaInP)	(GaP)	(GaP)	(AlGaInP)	(AlGaInP)	(AlGaInP)	(InGaN)	
Reverse voltage	V _R	5	5	5	5	5	5	5	5	V
Forward current	I _F	30	30	25	25	30	30	30	25	mA
Forward current (Peak) 1/10 Duty Cycle, 0.1ms Pulse Width	I _{FS}	195	150	140	135	150	150	150	150	mA
Power dissipation	P _D	75	84	62.5	62.5	75	75	75	102.5	mW
LED LAMPS:										
Operating temperature	T _A	-40~+85	-40~+85	-40~+85	-40~+85	-40~+85	-40~+85	-40~+85	-40~+85	°C
Storage temperature	T _{STG}	-40~+85	-40~+85	-40~+85	-40~+85	-40~+85	-40~+85	-40~+85	-40~+85	°C
LED DISPLAYS:										
Operating temperature	T _A	-40~+85	-40~+85	-40~+85	-40~+85	-40~+85	-40~+85	-40~+85	-40~+85	°C
Storage temperature	T _{STG}	-40~+85	-40~+85	-40~+85	-40~+85	-40~+85	-40~+85	-40~+85	-40~+85	°C

Operating Characteristics		SE-E Hyper Red	SE-H Hyper Red	G,SG Green, Super Bright Green	PG Pure Green	CGK Green	MGK Mega Green	MG Mega Green	ZG Green	Unit
		(AlGaInP)	(AlGaInP)	(GaP)	(GaP)	(AlGaInP)	(AlGaInP)	(AlGaInP)	(InGaN)	
Forward voltage (typ.) I _F =20mA	V _F	2.0	2.2	2.2	2.25	2.1	2.1	2.1	3.3	V
I _F =10mA		1.9	2.05	2.0	2.1	2.0	2.0	2.0	3.0	
I _F =2mA		1.8	1.85	1.9	1.9	1.9	1.9	1.9	2.65	
Forward voltage (max.) I _F =20mA, 10mA, 2mA	V _F	2.5	2.8	2.5	2.5	2.5	2.5	2.5	4.1	V
Reverse current V _R =5V	I _R	10	10	10	10	10	10	10	50	µA
Peak Emission Wavelength I _F =20mA, 10mA, 2mA	λ _p	630	640	565	555	574	574	574	515	nm
Dominant Wavelength I _F =20mA, 10mA, 2mA	λ _D	621	630	568	555	570	570	570	525	nm
Spectral line half-width I _F =20mA, 10mA, 2mA	Δλ _{1/2}	20	25	30	30	20	20	26	30	nm
Capacitance V _F =0V, f=1MHZ	C	25	27	15	45	15	15	20	45	pF

Absolute maximum ratings (T _A =25°C)		ZG-E Green (InGaN)	ZG-G Green (InGaN)	Y Yellow (GaAsP/GaP)	SYK Super Bright Yellow (AlGaInP)	SY-H Super Bright Yellow (AlGaInP)	QB-D Blue (InGaN)	QB-F Blue (InGaN)	QB-G Blue (InGaN)	Unit
Reverse voltage	V _R	5	5	5	5	5	5	5	5	V
Forward current	I _F	30	30	30	30	30	30	30	30	mA
Forward current (Peak) 1/10 Duty Cycle, 0.1ms Pulse Width	I _{FS}	100	100	140	175	140	150	150	150	mA
Power dissipation	P _D	120	120	75	75	84	120	120	120	mW
LED LAMPS:										
Operating temperature	T _A	-40~+85	-40~+85	-40~+85	-40~+85	-40~+85	-40~+85	-40~+85	-40~+85	°C
Storage temperature	T _{STG}	-40~+85	-40~+85	-40~+85	-40~+85	-40~+85	-40~+85	-40~+85	-40~+85	°C
LED DISPLAYS:										
Operating temperature	T _A	-40~+85	-40~+85	-40~+85	-40~+85	-40~+85	-40~+85	-40~+85	-40~+85	°C
Storage temperature	T _{STG}	-40~+85	-40~+85	-40~+85	-40~+85	-40~+85	-40~+85	-40~+85	-40~+85	°C

Operating Characteristics		ZG-E Green (InGaN)	ZG-G Green (InGaN)	Y Yellow (GaAsP/GaP)	SYK Super Bright Yellow (AlGaInP)	SY-H Super Bright Yellow (AlGaInP)	QB-D Blue (InGaN)	QB-F Blue (InGaN)	QB-G Blue (InGaN)	Unit
Forward voltage (typ.) I _F =20mA	V _F	3.2	3.2	2.1	2.0	2.3	3.3	3.3	3.3	V
I _F =10mA		3.05	3.05	1.95	1.95	2.2	3.0	3.0	3.0	
I _F =2mA		2.8	2.8	1.85	1.85	2.0	2.65	2.65	2.65	
Forward voltage (max.) I _F =20mA, 10mA, 2mA	V _F	4.0	4.0	2.5	2.5	2.8	4.0	4.0	4.0	V
Reverse current V _R =5V	I _R	50	50	10	10	10	50	50	50	uA
Peak Emission Wavelength I _F =20mA, 10mA, 2mA	λ _p	520	520	590	590	590	468	461	461	nm
Dominant Wavelength I _F =20mA, 10mA, 2mA	λ _D	525	525	588	590	589	470	465	465	nm
Spectral line half-width I _F =20mA, 10mA, 2mA	Δλ _{1/2}	35	35	35	20	20	25	25	25	nm
Capacitance V _F =0V, f=1MHZ	C	100	100	20	20	45	100	100	100	pF

Kingbright TECHNICAL DATA 5V/12V/14V WITH INTERNAL RESISTANCE

Absolute maximum ratings ($T_A=25^{\circ}\text{C}$)		E,I Hi.Eff.Red (GaAsP/GaP)	SR Super Bright Red (GaAlAs)	G,SG Green, Super Bright Green (GaP)	Y Yellow (GaAsP/GaP)	Unit
Reverse voltage	V_R	5	5	5	5	V
Forward voltage (Max.) for 5V	V_F	6	6	6	6	V
Forward voltage (Max.) for 12V	V_F	14	14	14	14	V
Forward voltage (Max.) for 14V	V_F	16	16	16	16	V
Power dissipation for 5V	P_D	85	85	85	85	mW
Power dissipation for 12V	P_D	120	120	120	120	mW
Power dissipation for 14V	P_D	160	160	160	160	mW
LED LAMPS:						
Operating temperature	T_A	-40~+70	-40~+70	-40~+70	-40~+70	$^{\circ}\text{C}$
Storage temperature	T_{STG}	-40~+85	-40~+85	-40~+85	-40~+85	$^{\circ}\text{C}$
LED DISPLAYS:						
Operating temperature	T_A	-40~+70	-40~+70	-40~+70	-40~+70	$^{\circ}\text{C}$
Storage temperature	T_{STG}	-40~+85	-40~+85	-40~+85	-40~+85	$^{\circ}\text{C}$

Operating Characteristics		E,I Hi.Eff.Red (GaAsP/GaP)	SR Super Bright Red (GaAlAs)	G,SG Green, Super Bright Green (GaP)	Y Yellow (GaAsP/GaP)	Unit
Forward current (typ.) $V_F=5\text{V}$	I_F	13	13	11.5	13	mA
Forward current (typ.) $V_F=12\text{V}$	I_F	8.5	8.5	8.5	8.5	mA
Forward current (typ.) $V_F=14\text{V}$	I_F	10.5	10.5	10.5	10.5	mA
Forward current (max.) $V_F=5\text{V}$	I_F	17.5	17.5	17.5	17.5	mA
Forward current (max.) $V_F=12\text{V}$	I_F	11.5	11.5	11.5	11.5	mA
Forward current (max.) $V_F=14\text{V}$	I_F	13.5	13.5	13.5	13.5	mA
Reverse current $V_R=5\text{V}$	I_R	10	10	10	10	μA
Peak Emission Wavelength $V_F=5\text{V},12\text{V},14\text{V}$	λ_p	627	660	565	590	nm
Dominant Wavelength $V_F=5\text{V},12\text{V},14\text{V}$	λ_D	625	640	568	588	nm
Spectral line half-width $V_F=5\text{V},12\text{V},14\text{V}$	$\Delta\lambda_{1/2}$	45	20	30	35	nm

Absolute maximum ratings (T _A =25°C)		E,I Hi.Eff.Red (GaAsP/GaP)	H Bright Red (GaP)	SR Super Bright Red (GaAlAs)	G,SG Green, Super Bright Green (GaP)	Y Yellow (GaAsP/GaP)	Unit
Reverse voltage	V _R	● 0.5	● 0.5	● 0.5	● 0.5	● 0.5	V
Forward voltage (max.)	V _F	14	14	14	14	14	V
Total Power dissipation	P _D	310	310	310	310	310	mW
Operating temperature	T _A	-40~+70	-40~+70	-40~+70	-40~+70	-40~+70	°C
Storage temperature	T _{STG}	-40~+85	-40~+85	-40~+85	-40~+85	-40~+85	°C

Operating Characteristics		E,I Hi.Eff.Red (GaAsP/GaP)	H Bright Red (GaP)	SR Super Bright Red (GaAlAs)	G,SG Green, Super Bright Green (GaP)	Y Yellow (GaAsP/GaP)	Unit
Forward current (min.) V _F =3.5V	I _F	● 8	● 8	● 8	● 8	● 8	mA
Forward current (typ.) V _F =5V	I _F	22	22	22	22	22	mA
Supply current V _F =3.5V ~ 14V	I _{SON}	8 ~ 44	8 ~ 44	8 ~ 44	8 ~ 44	8 ~ 44	mA
Blink frequency V _F =3.5V ~ 14V	f	3 ~ 1.5	3 ~ 1.5	3 ~ 1.5	3 ~ 1.5	3 ~ 1.5	Hz
Peak Emission Wavelength	λ _p	627	700	660	565	590	nm
Dominant Wavelength	λ _D	625	660	640	568	588	nm
Spectral line half-width	Δλ _{1/2}	45	45	20	30	35	nm

Absolute maximum ratings ($T_A=25^{\circ}\text{C}$)		F3 (GaAs)	SF4 (GaAlAs)	SF6 (GaAlAs)	SF7 (GaAlAs)	Unit
Reverse voltage	V_R	5	5	5	5	V
Forward current	I_F	50	50	50	50	mA
Forward current (Peak) 1/100 Duty Cycle, 10 μs Pulse Width	i_{FS}	1.2	1.2	1	1	A
Power dissipation	P_D	80	80	80	80	mW
LED LAMPS:						
Operating temperature	T_A	-40~+85	-40~+85	-40~+85	-40~+85	$^{\circ}\text{C}$
Storage temperature	T_{STG}	-40~+85	-40~+85	-40~+85	-40~+85	$^{\circ}\text{C}$
LED DISPLAYS:						
Operating temperature	T_A	-40~+85	-40~+85	-40~+85	-40~+85	$^{\circ}\text{C}$
Storage temperature	T_{STG}	-40~+85	-40~+85	-40~+85	-40~+85	$^{\circ}\text{C}$

Operating Characteristics		F3 (GaAs)	SF4 (GaAlAs)	SF6 (GaAlAs)	SF7 (GaAlAs)	Unit
Forward voltage (typ.) $I_F=20\text{mA}$	V_F	1.2	1.3	1.35	1.4	V
Forward voltage (max.) $I_F=20\text{mA}$	V_F	1.6	1.6	1.6	1.6	V
Reverse current $V_R=5\text{V}$	I_R	10	10	10	10	μA
Peak Emission Wavelength $I_F=20\text{mA}$	λ_p	940	880	860	850	nm
Spectral line half-width $I_F=20\text{mA}$	$\Delta\lambda_{1/2}$	50	50	50	50	nm
Capacitance $V_F=0\text{V}, f=1\text{MHZ}$	C	90	90	30	30	pF

High Efficiency Red,Orange

E,I : GaAsP/GaP

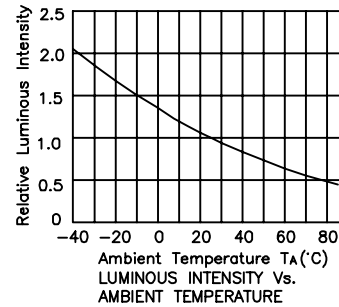
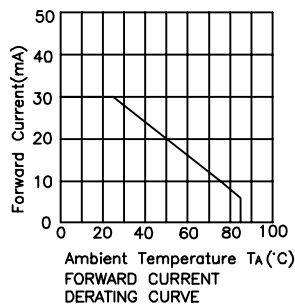
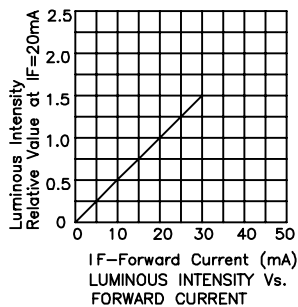
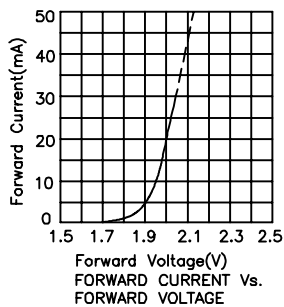

Bright Red

H : GaP

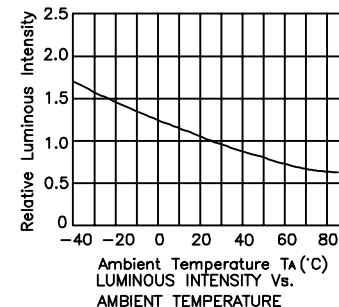
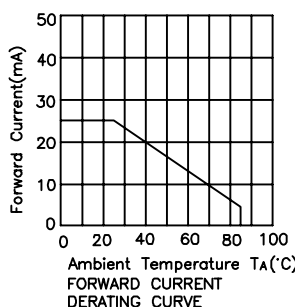
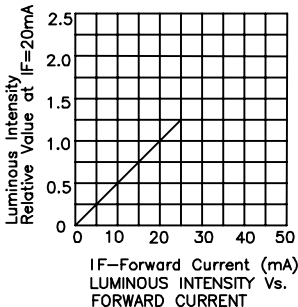
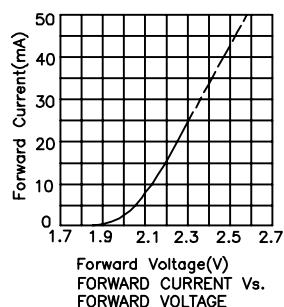

Super Bright Red

SR : GaAlAs

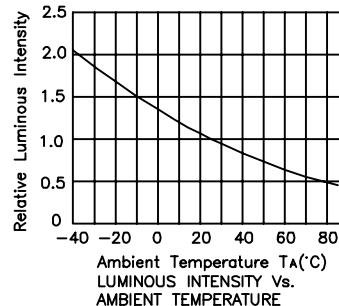
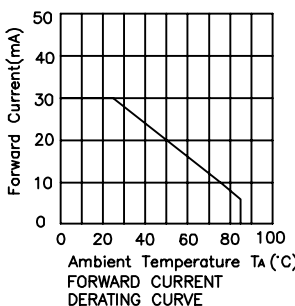
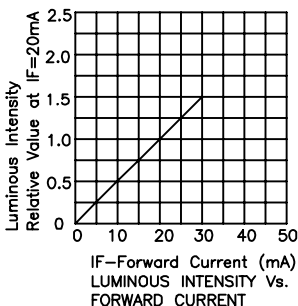
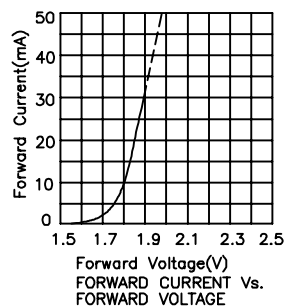

Hyper Red

SURK : AlGaInP

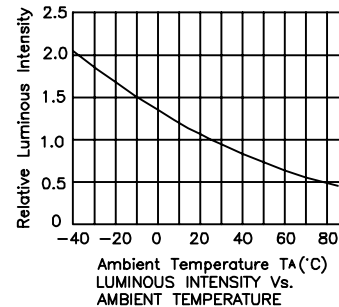
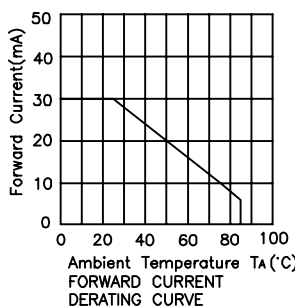
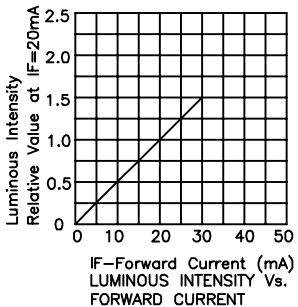
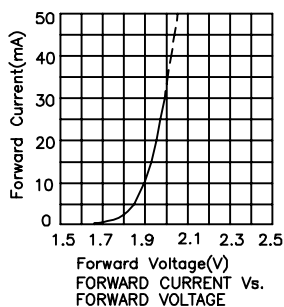

Hyper Red

SUR-E : AlGaInP

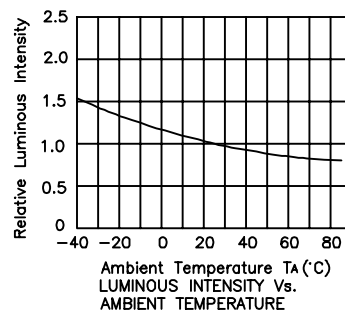
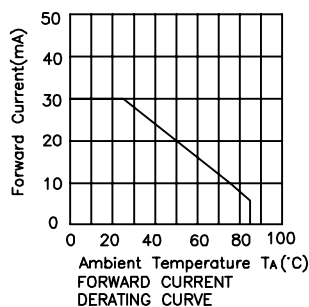
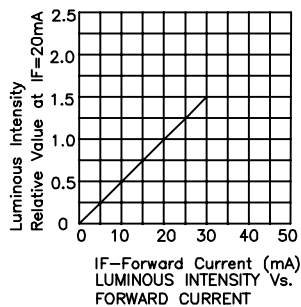
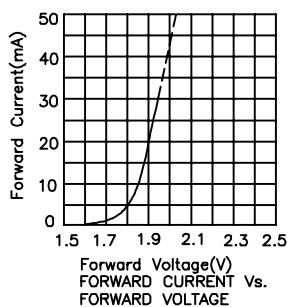

Hyper Red

SUR-G : AlGaInP

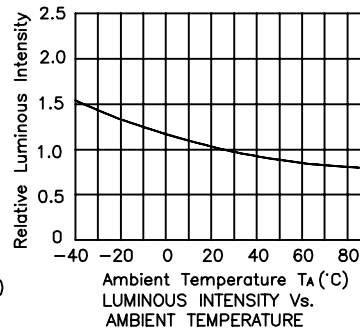
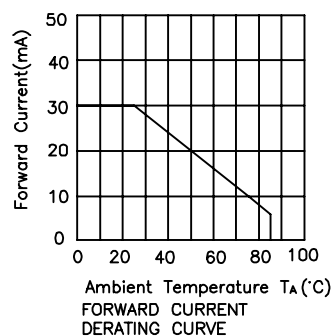
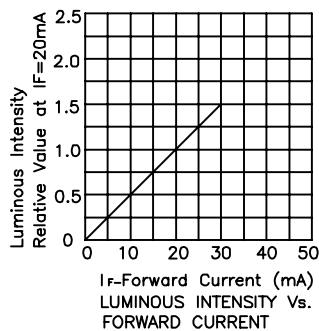
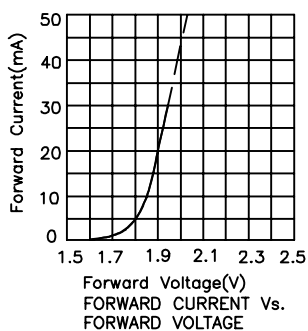

Pure Orange

N : GaAsP/GaP

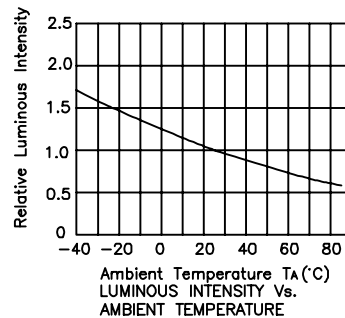
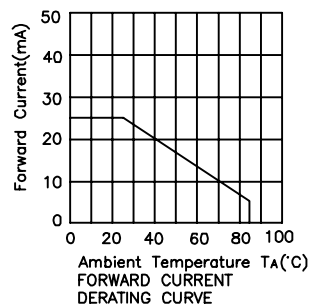
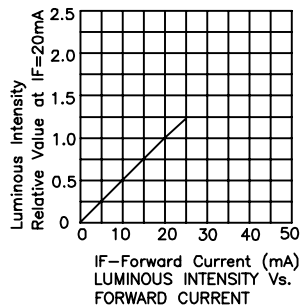
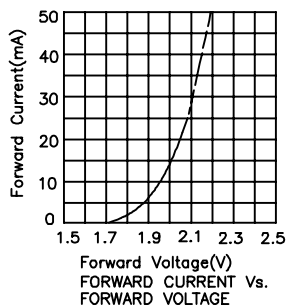

Super Bright Orange

SEK : AlGaInP

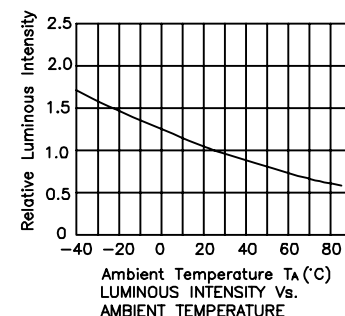
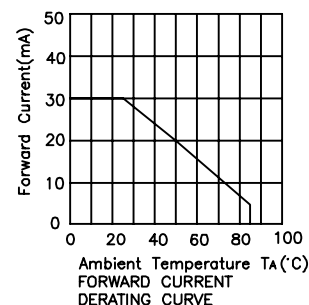
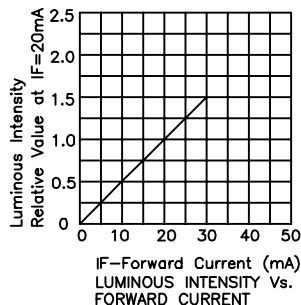
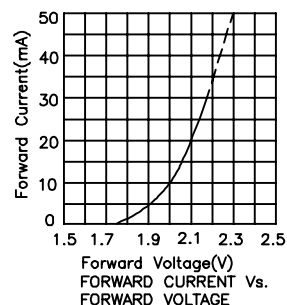

Hyper Red

SE-E : AlGaInP

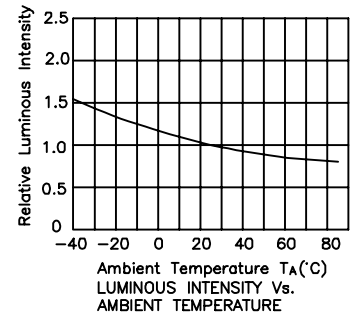
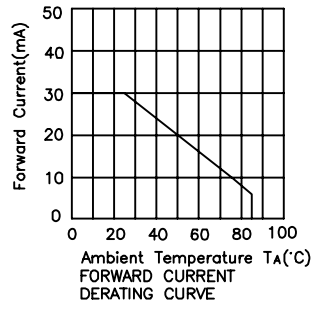
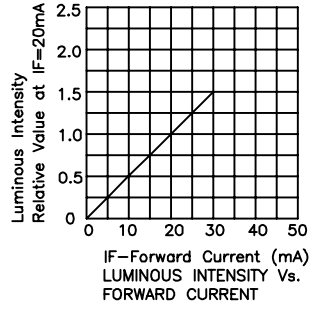
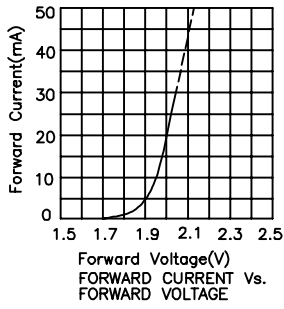

Hyper Red

SE-H : AlGaInP

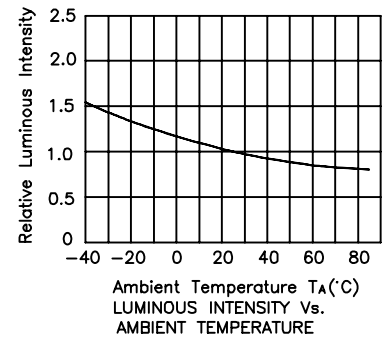
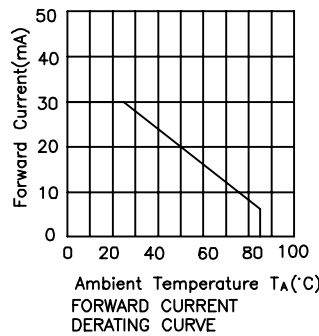
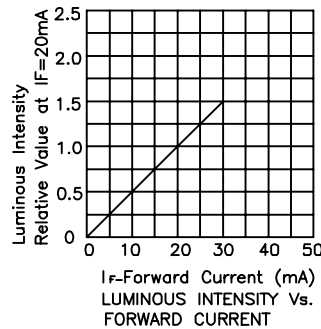
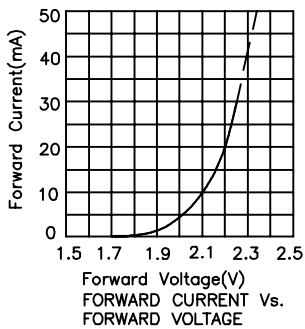

Green, Super Bright Green

G,SG : GaP

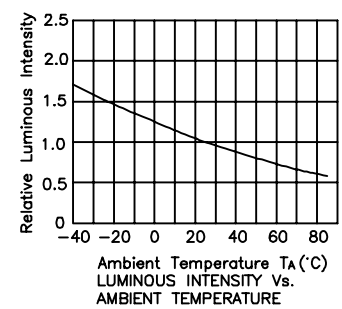
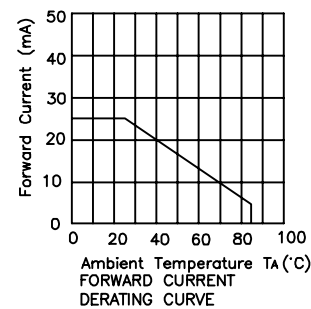
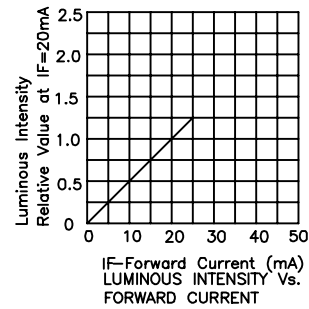
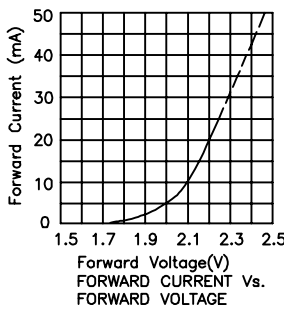

Pure Green

PG : GaP

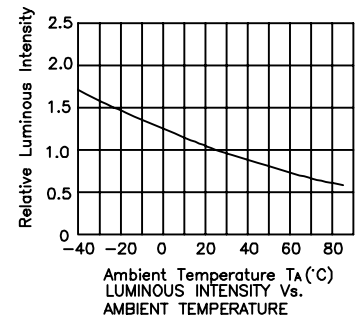
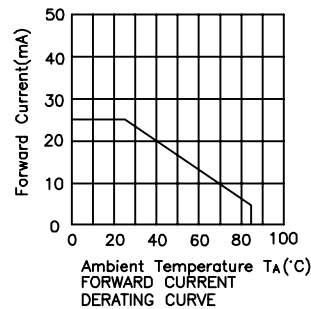
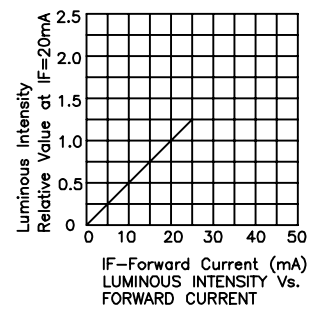
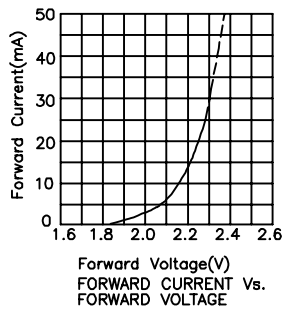

Green

CGK : AlGaInP

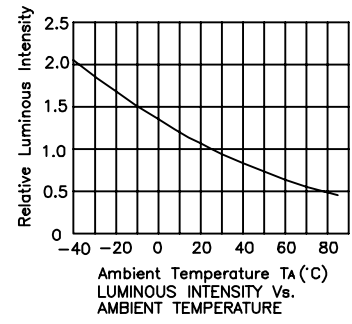
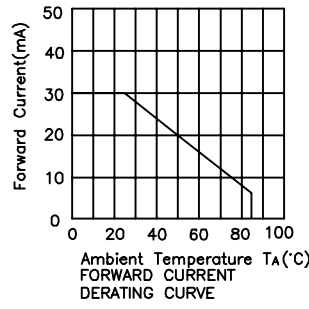
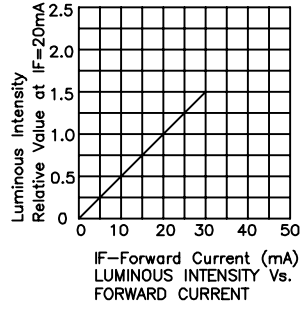
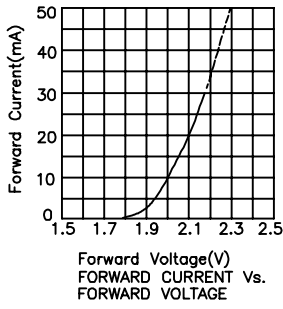

Mega Green

MGK : AlGaInP

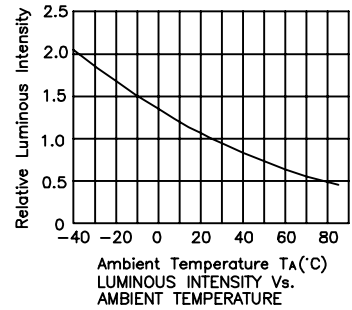
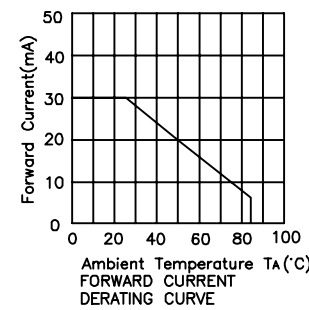
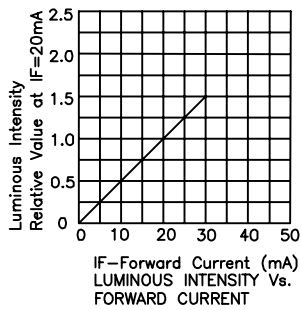
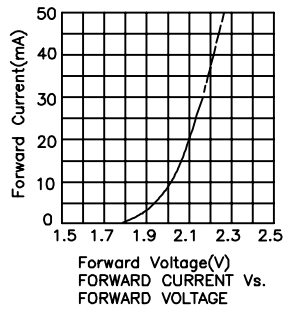

Mega Green

MG : AlGaInP

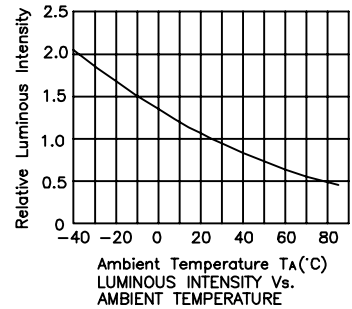
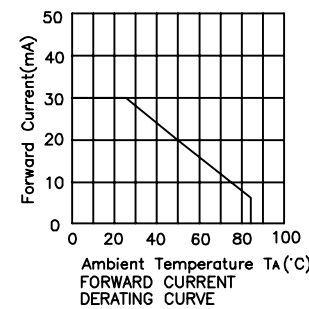
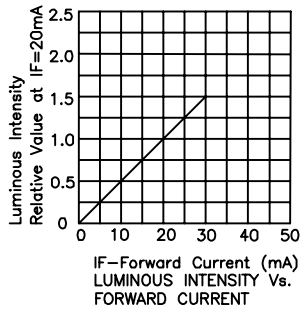
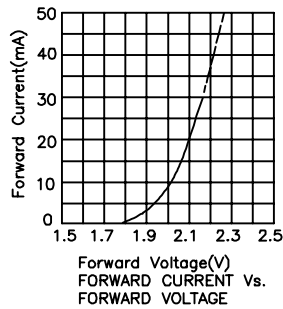

Green

ZG : InGaN

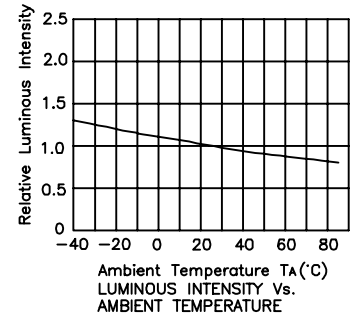
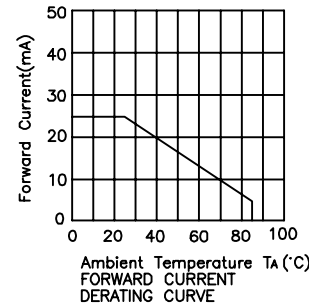
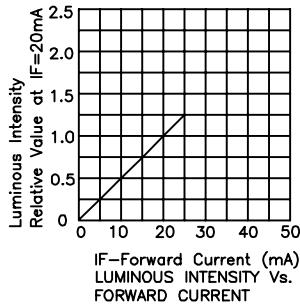
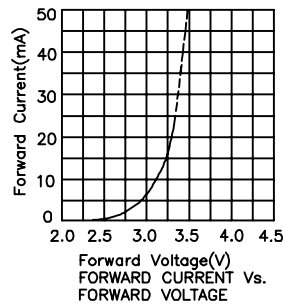

Green

ZG-E : InGaN

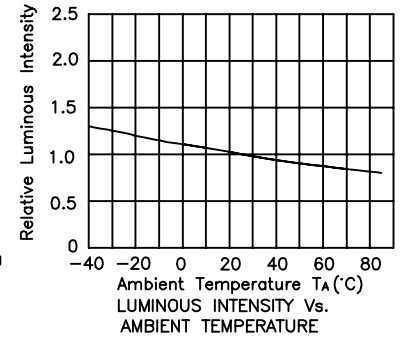
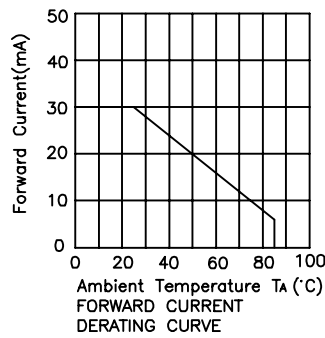
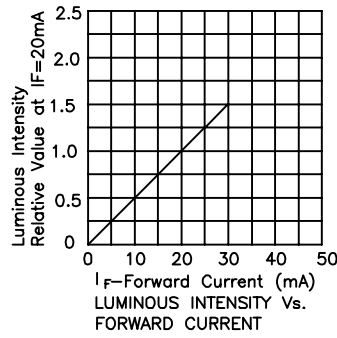
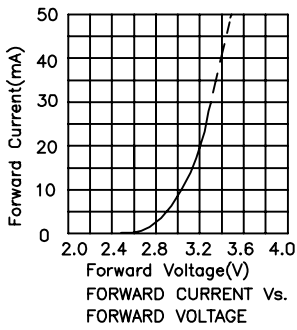

Green

ZG-G : InGaN

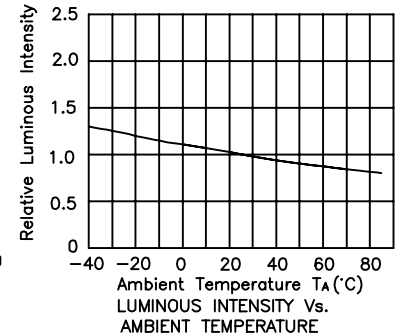
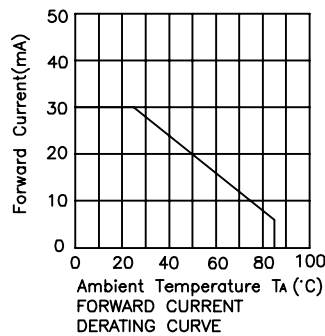
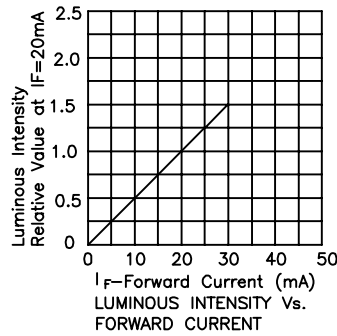
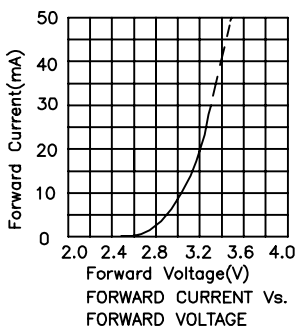

Yellow

Y : GaAsP/GaP

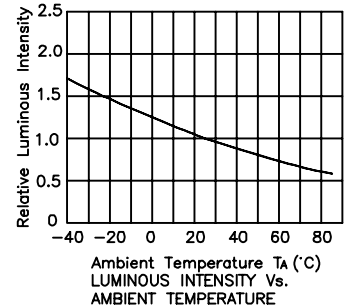
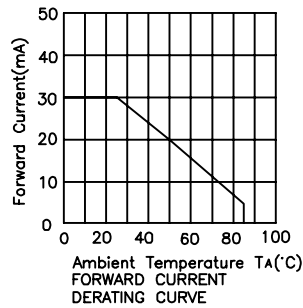
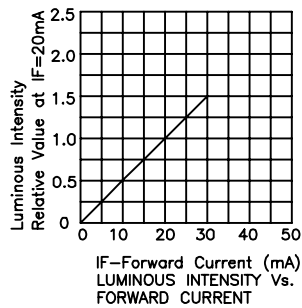
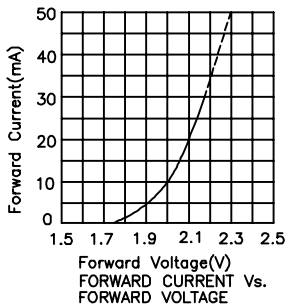

Super Bright Yellow

SYK : AlGaInP

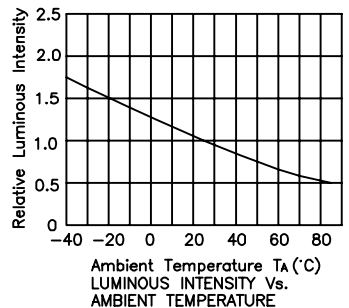
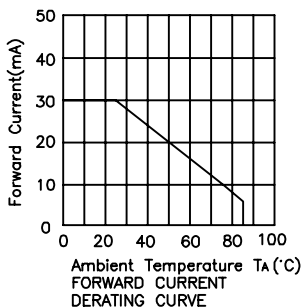
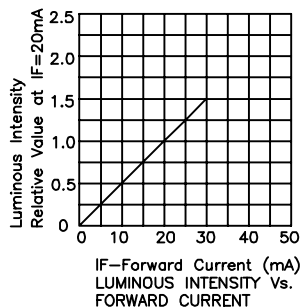
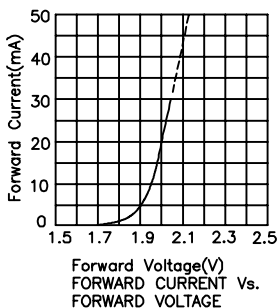

Super Bright Yellow

SY-H : AlGaInP

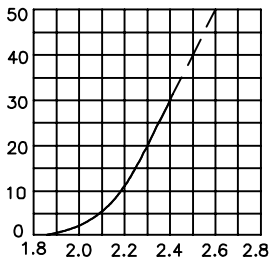

Forward Voltage(V)
FORWARD CURRENT Vs.
FORWARD VOLTAGE

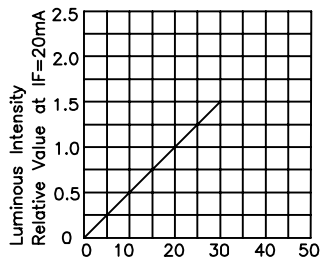

If-Forward Current (mA)
LUMINOUS INTENSITY Vs.
FORWARD CURRENT

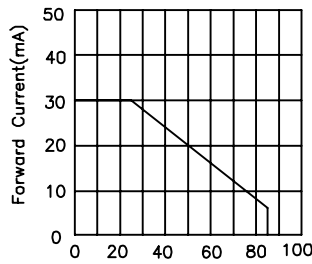

Ambient Temperature T_A (°C)
FORWARD CURRENT
DERATING CURVE

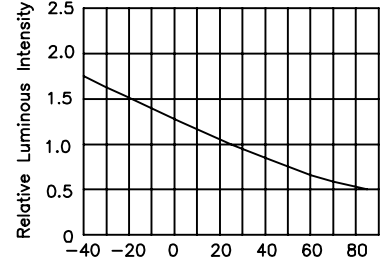

Ambient Temperature T_A (°C)
LUMINOUS INTENSITY Vs.
AMBIENT TEMPERATURE

Blue

QB-D: InGaN

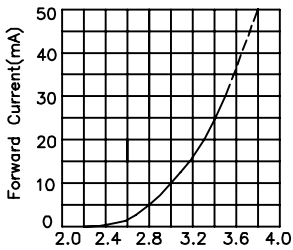

Forward Voltage(V)
FORWARD CURRENT Vs.
FORWARD VOLTAGE

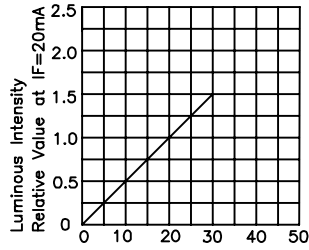

If-Forward Current (mA)
LUMINOUS INTENSITY Vs.
FORWARD CURRENT

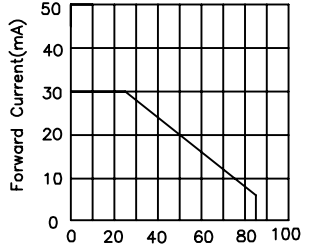

Ambient Temperature T_A (°C)
FORWARD CURRENT
DERATING CURVE

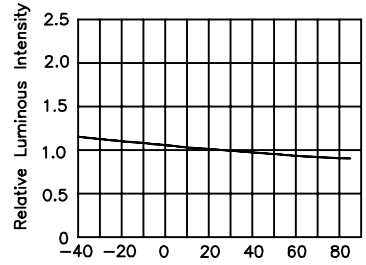

Ambient Temperature T_A (°C)
LUMINOUS INTENSITY Vs.
AMBIENT TEMPERATURE

Blue

QB-F: InGaN

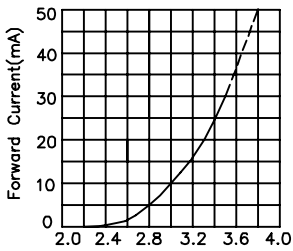

Forward Voltage(V)
FORWARD CURRENT Vs.
FORWARD VOLTAGE

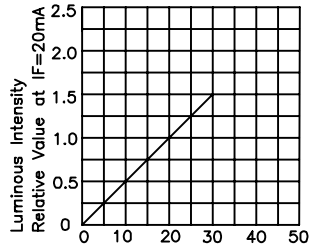

If-Forward Current (mA)
LUMINOUS INTENSITY Vs.
FORWARD CURRENT

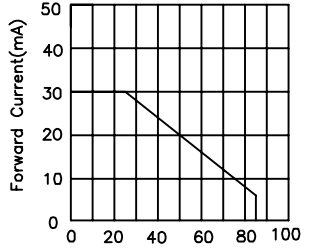

Ambient Temperature T_A (°C)
FORWARD CURRENT
DERATING CURVE

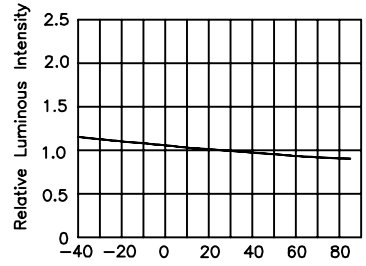

Ambient Temperature T_A (°C)
LUMINOUS INTENSITY Vs.
AMBIENT TEMPERATURE

Blue

QB-G: InGaN

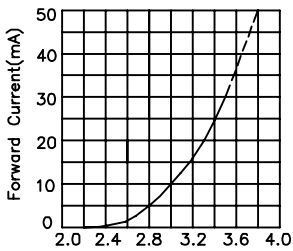

Forward Voltage(V)
FORWARD CURRENT Vs.
FORWARD VOLTAGE

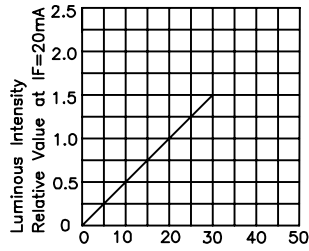

If-Forward Current (mA)
LUMINOUS INTENSITY Vs.
FORWARD CURRENT

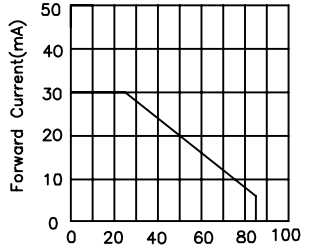

Ambient Temperature T_A (°C)
FORWARD CURRENT
DERATING CURVE

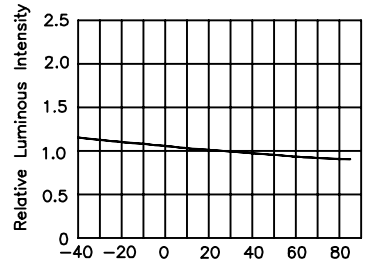

Ambient Temperature T_A (°C)
LUMINOUS INTENSITY Vs.
AMBIENT TEMPERATURE

SELECTION CODE FOR STANDARD LEDS (T _A =25°C)					
Group	Light intensity in mcd(10mA)		Group	Light intensity in mcd(10mA)	
	min.	max.		min.	max.
F	0.1	0.25	W	110	200
G	0.2	0.4	X	170	280
H	0.3	0.6	Y	230	350
I	0.4	1	Z	300	500
K	0.7	1.5	ZA	400	620
L	1	3	ZB	520	750
M	1.8	5	ZC	650	1200
N	3	7	ZD	900	1800
P	5	12	ZE	1400	2400
Q	8	17	ZF	1900	3000
R	12	23	ZG	2500	3600
S	18	35	ZH	3100	4500
T	28	55	ZM	4000	5400
U	40	90	ZN	4800	6500
V	70	130	ZP	5900	7600

SELECTION CODE FOR SUPER BRIGHT LEDS (T _A =25°C)					
Group	Light intensity in mcd(20mA)		Group	Light intensity in mcd(20mA)	
	min.	max.		min.	max.
A	1.6	3.5	ZA	2800	3800
B	2.6	5.5	ZB	3300	4500
C	4	10	ZC	3800	5500
D	7	15	ZD	4700	6500
E	10	24	ZE	5700	7500
F	18	44	ZF	6700	8500
G	36	60	ZG	7500	10000
H	50	90	ZH	8000	12000
M	70	130	ZM	10000	16000
N	110	220	ZN	12000	20000
P	180	320	ZP	16000	24000
Q	280	420	ZQ	20000	32000
R	380	550	ZR	24000	40000
S	480	750	ZS	32000	50000
T	650	1100	ZT	40000	60000
U	900	1500	ZU	50000	80000
V	1200	1800	ZV	70000	150000
W	1500	2100	ZW	110000	220000
X	1800	2500	ZX	180000	360000
Y	2200	3000	ZY	280000	560000
Z	2500	3300	ZZ	420000	900000

SELECTION CODE FOR DISPLAYS (T _A =25°C)					
Group	Light intensity in ucd(10mA)		Group	Light intensity in ucd(10mA)	
	min.	max.		min.	max.
C	60	160	P	12000	24000
D	120	280	Q	18000	36000
E	200	410	R	26000	60000
F	300	640	S	44000	101000
G	480	1040	T	75000	173000
H	800	1600	U	128000	293000
I	1200	2500	V	217000	498000
K	1900	4100	W	368000	846000
L	3000	6400	X	626000	1438000
M	4700	10500	Y	1063000	2445000
N	8000	16000	Z	1807000	4156000

SELECTION CODE FOR INFRARED EMITTING DIODES (T _A =25°C)					
Group	Radiant intensity in mW/sr(20mA)		Group	Radiant intensity in mW/sr(20mA)	
	min.	max.		min.	max.
AK	0.5	2	D	7	15
AL	0.8	3.2	E	10	24
A	1.6	3.5	F	18	44
B	2.6	5.5	G	36	60
C	4	10	H	50	90

SELECTION CODE FOR NPN PHOTOTRANSISTORS (T _A =25°C)					
Group	Photocurrent(mA)		Group	Photocurrent(mA)	
	min.	max.		min.	max.
F	0.1	0.25	L	1	3
G	0.2	0.4	M	1.8	5
H	0.3	0.6	N	3	7
I	0.4	1	P	5	12
K	0.7	1.5			

SELECTION CODE FOR LUMINOUS FLUX								
(T _A =25°C; Tolerance: +/-15%)								
Group	Luminous Flux in lm		Group	Luminous Flux in lm		Group	Luminous Flux in lm	
	min.	max.		min.	max.		min.	max.
A1	0.5	0.6	B2	12	14	C6	210	240
A2	0.6	0.7	B3	14	17	C7	240	280
A3	0.7	0.8	B4	17	20	C8	280	320
A4	0.8	1	B5	20	24	C9	320	370
A5	1	1.2	B6	24	29	C10	370	430
A6	1.2	1.4	B7	29	35	C11	430	490
A7	1.4	1.7	B8	35	42	C12	490	560
A8	1.7	2	B9	42	50	C13	560	640
A9	2	2.4	B10	50	60	C14	640	740
A10	2.4	2.9	B11	60	70	C15	740	850
A11	2.9	3.5	B12	70	80	C16	850	1000
A12	3.5	4.2	B13	80	90	D1	1000	1200
A13	4.2	5	B14	90	100	D2	1200	1400
A14	5	6	C1	100	120	D3	1400	1600
A15	6	7.2	C2	120	140	D4	1600	1800
A16	7.2	8.6	C3	140	160	D5	1800	2100
A17	8.6	10	C4	160	180	-	-	-
B1	10	12	C5	180	210	-	-	-

COLOR CODE FOR GREEN LEDS + DISPLAYS		
(T _A =25°C)		
Group	Dom. Wavelength (nm)	
	ZG	
	min.	max.
1	513	522
2	518	527
3	523	532
4	528	537

COLOR CODE FOR BLUE LEDS + DISPLAYS					
(T _A =25°C)					
Group	Dom. Wavelength (nm)		Group	Dom. Wavelength (nm)	
	min.	max.		min.	max.
1	443	452	3A	469	475
2	448	457	3B	471	477
3	453	462	4A	473	479
1A	458	465	4B	475	481
1B	461	468	5A	477	483
2A	464	471	5B	479	485
2B	467	473	5C	481	488

COLOR CODE FOR LEDS + DISPLAYS				
(T _A =25°C, Tolerance: +/-1nm)				
Group	Dom. Wavelength (nm)			
	Green		Yellow	
	min.	max.	min.	max.
0	556	559		
1	559	561	581	584
2	561	563	584	586
3	563	565	586	588
4	565	567	588	590
5	567	569	590	592
6	569	571	592	594
7	571	573	594	597
8	573	575	597	600

SOLDERING INSTRUCTIONS						
Types	Dip soldering / * wave soldering			Iron soldering (with 1.5mm iron tip)		
	Temperature of the soldering bath	Maximum soldering time	Distance from solder joint to package	Temperature of soldering iron	Maximum soldering time	Distance from solder joint to package
LEDS	<=260°C	3s	>=2mm	<=350°C	3s	>2mm
	<=260°C	5s	>=5mm	<=350°C	5s	>5mm
SMDS [1]	/	/	/	<=350°C	3s	/
DISPLAYS	* <=260°C	* 3s	* >2mm	<=350°C	3s	>2mm
PHOTOCOUPLER	<=260°C	3s	>2mm	<=310°C	3s	/
	/	/	/	<=260°C	10s	/

NOTE: 1. one time only

Kingbright

Optoelectronic Components



Application Notes **135**

CIE Chromaticity Diagram **141**



Soldering

General Notes

1. We recommend manual soldering operations only for repair and rework purposes. The soldering iron should not exceed 30W in power. The maximum soldering temperature is 300°C for Pb-Sn solder and 350°C for lead-free solder for normal lamps and displays. For blue (425nm), and blue-green (525nm) LEDs, the maximum soldering iron temperature is 280°C. Do not place the soldering iron on the component for more than 3 seconds.



2. The tip of soldering iron should never touch the lens epoxy.
3. Do not apply stress to the leads when the component is heated above 85°C otherwise internal wire bonds may be damaged.
4. SMD products must be mounted according to specified soldering pad patterns. Refer to the product datasheet for details. Solder paste must be evenly applied to each soldering pad to insure proper bonding and positioning of the component.

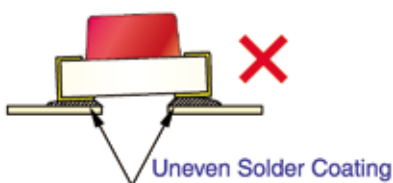

5. After soldering, allow at least three minutes for the component to cool to room temperature before further operations.

Recommended PCB pin hole diameters for display products are list below :

Round pin type : 2 x pin diameters

Square pin type :

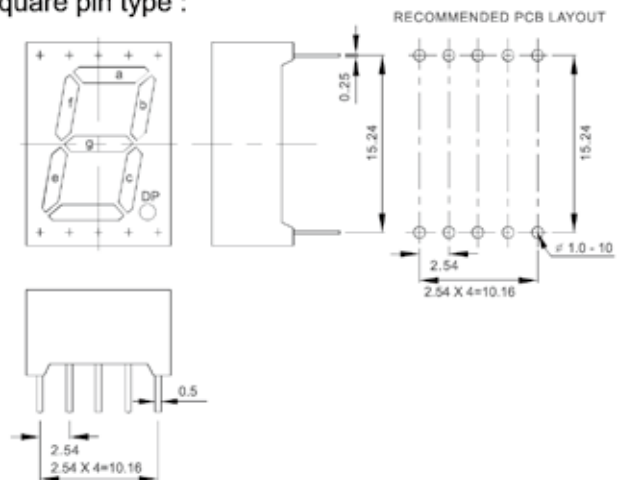

Recommended Wave Soldering Profiles For Kingbright Through-Hole Products

1. Wave Soldering Profile With Pb-Sn Solder

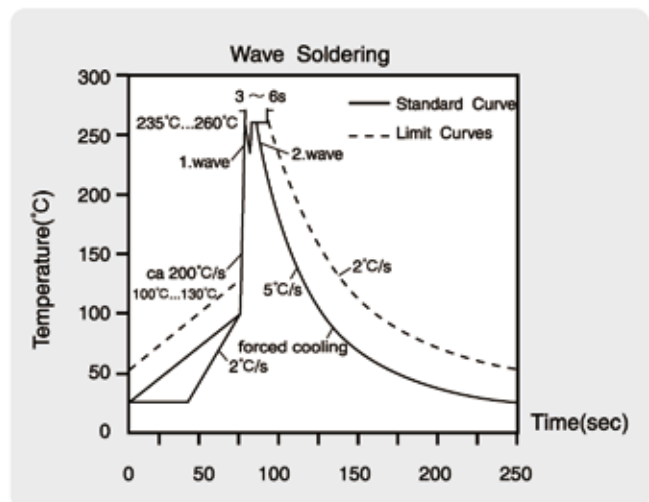

2. Lead-Free Wave Soldering Profile

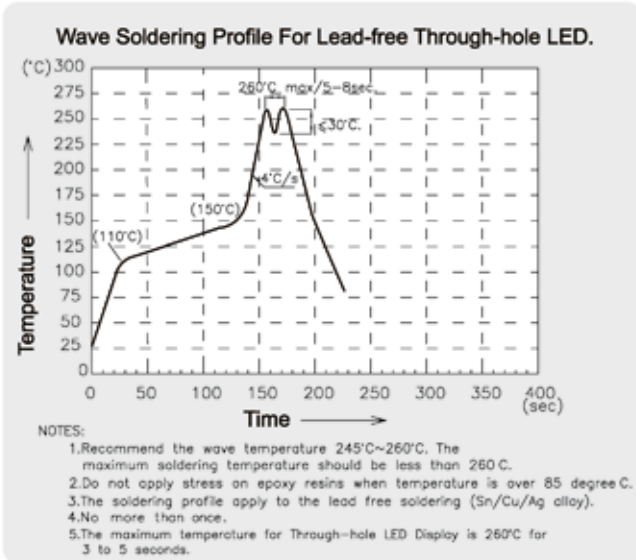

2. Lead-Free Reflow Soldering Profile

No more than two soldering passes with the recommended profile.

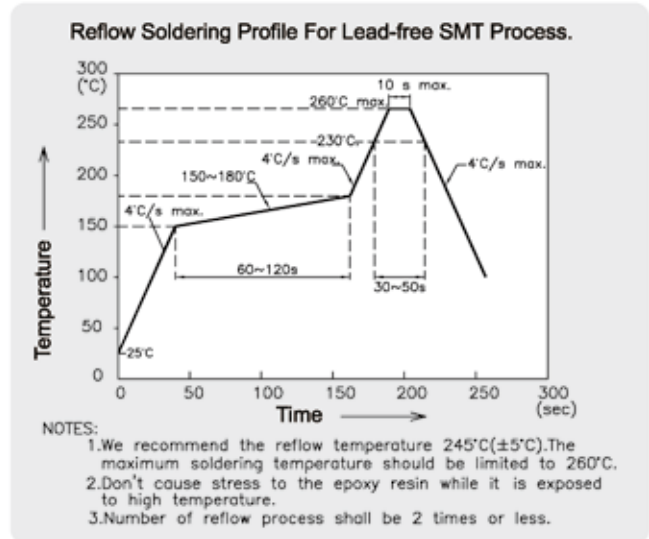

Recommended Reflow Soldering Profiles For Kingbright SMD Products

1. Reflow Soldering Profile With Pb-Sn Solder

No more than two soldering passes with the recommended profile.

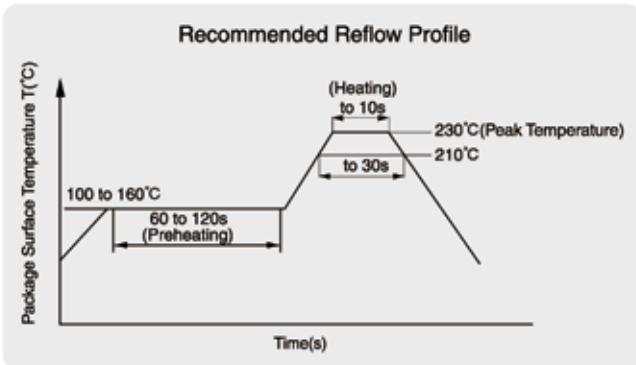

Static Electricity and Voltage Spikes in InGaN/GaN Products

InGaN/GaN products are sensitive to electrostatic discharge (ESD) and other transient voltage spikes. ESD and voltage spikes can affect the component's reliability, increase reverse current, and decrease forward voltage. This may result in reduced light intensity or cause component failure.

Kingbright InGaN/GaN products are stored in anti-static packaging for protection during transport and storage. Please note the anti-static measures below when handling Kingbright InGaN/GaN products:



Design Precautions

Products using InGaN/GaN components must incorporate protection circuitry to prevent ESD and voltage spikes from reaching the vulnerable component.

ESD Protection During Production

Static discharge can result when static-sensitive products come in contact with the operator or other conductors. The following procedures may decrease the possibility of ESD damage:

1. Minimize friction between the product and surroundings to avoid static buildup.
2. All production machinery and test instruments must be electrically grounded.
3. Operators must wear anti-static bracelets.
4. Wear anti-static suit when entering work areas with conductive machinery.
5. Set up ESD protection areas using grounded metal plating for component handling.
6. All workstations that handle IC and ESD-sensitive components must maintain an electrostatic potential of 150V or less.
7. Maintain a humidity level of 50% or higher in production areas.
8. Use anti-static packaging for transport and storage.
9. All anti-static equipment and procedures should be periodically inspected and evaluated for proper functionality.

LED Mounting Method

1. The lead pitch of the LED must match the pitch of the mounting holes on the PCB during component placement. Lead-forming may be required to insure the lead pitch matches the hole pitch. Refer to the figure below for proper lead forming procedures.

(Fig. 1)

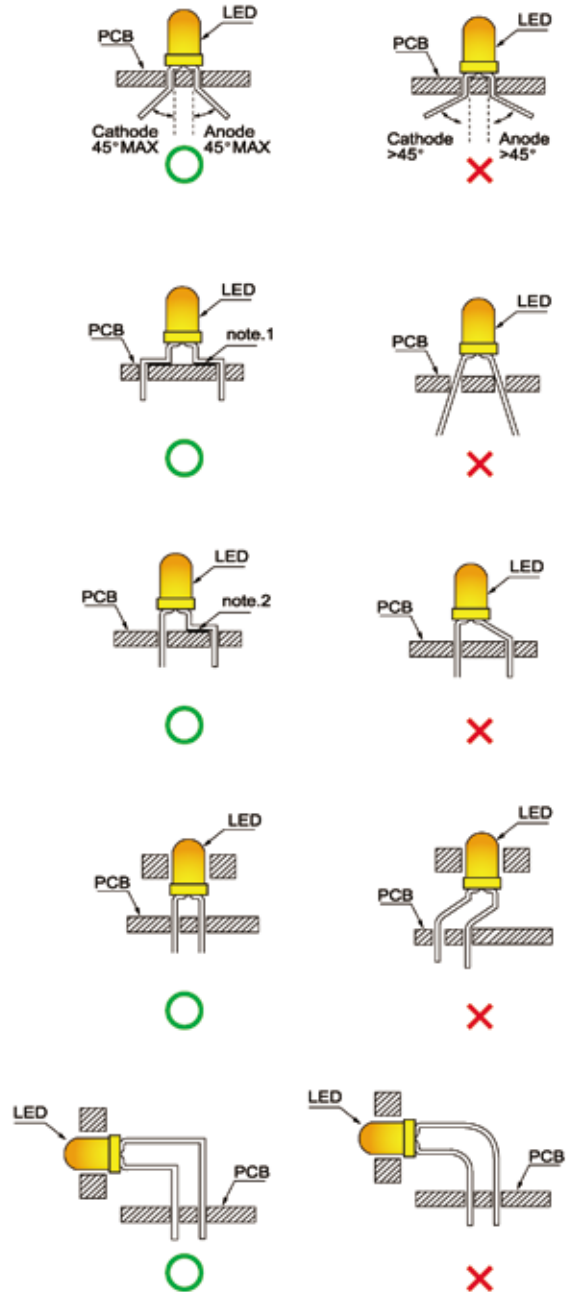

Fig. 1

"○" Correct mounting method
 "✗" Incorrect mounting method
 Note 1-2 : Do not route PCB trace in the contact area between the leadframe and the PCB to prevent short-circuits.

- When soldering wire to the LED, use individual heat-shrink tubing to insulate the exposed leads to prevent accidental contact short-circuit. (Fig. 2)

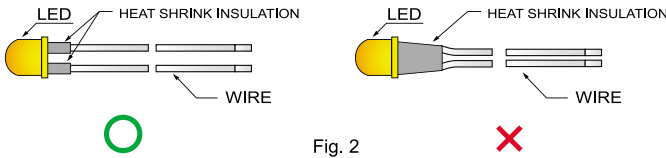

Fig. 2

- Use stand-offs (Fig. 3) or spacers (Fig. 4) to securely position the LED above the PCB.

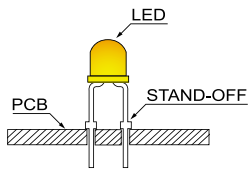

Fig. 3

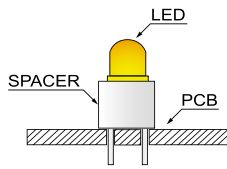

Fig. 4

Lead Forming Procedures

- Maintain a minimum of 2mm clearance between the base of the LED lens and the first lead bend. (Fig. 5 and 6)

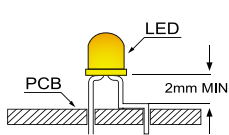

Fig. 5

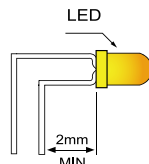

Fig. 6

- Lead forming or bending must be performed before soldering, never during or after soldering.

- Do not stress the LED lens during lead-forming in order to prevent fractures in the lens epoxy and damage the internal structures.
- During lead forming, use tools or jigs to hold the leads securely so that the bending force will not be transmitted to the LED lens and its internal structures. Do not perform lead forming once the component has been mounted onto the PCB. (Fig. 7)

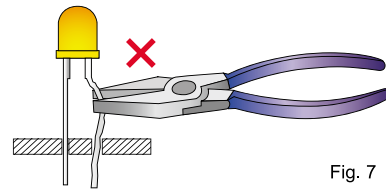

Fig. 7

- Do not bend the leads more than twice. (Fig. 8)

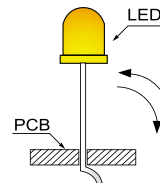

Fig. 8

- After soldering or other high-temperature assembly, allow the LED to cool down to 50° C before applying outside force (Fig. 9). In general, avoid placing excess force on the LED to avoid damage. For any questions please consult with Kingbright representative for proper handling procedures.

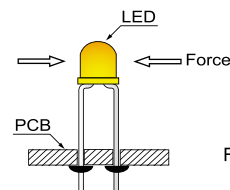

Fig. 9

Cleaning

1. Do not use harsh organic solvents such as trichloroethylene, acetone, Chlorosen, and Diflon S3MC for cleaning because they may cloud or damage the LED lens.
2. Isopropyl alcohol or deionized water are recommended solvents for cleaning.
3. Special attention should be taken if other chemicals are used for cleaning because other solvents may damage the epoxy in the lens or housing.
4. The cleaning process should take place at room temperature and the devices should not be washed for more than one minute.
5. When water is used in the cleaning process, immediately remove excess moisture from the LED via forced-air drying afterwards.

Miscellaneous Design Notes

1. Protective current-limiting resistors may be necessary to operate the LEDs within the specified range.
2. LEDs mounted in parallel should each be placed in series with its own current-limiting resistor.

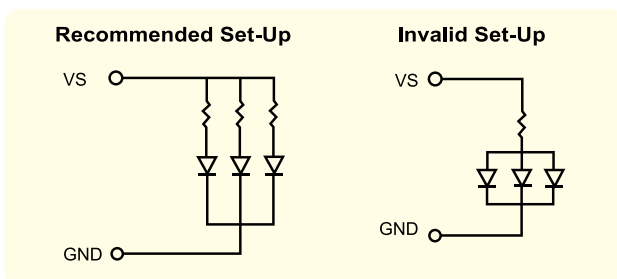

3. The driving circuit should be designed to avoid reverse voltages and transient voltage spikes when the circuit is powered up or shut down.

4. During soldering, SMD components should be mounted such that the leads are placed perpendicular to the direction of PCB travel to insure the solder on each lead melts simultaneously during re-flow.

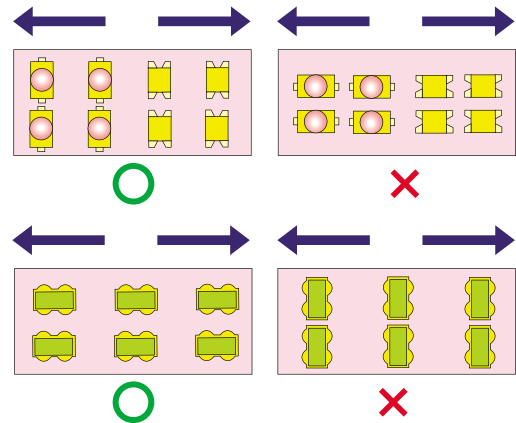

5. Optimal usage of high-power LED devices requires careful design by the end-user to optimize heat dissipation, such as increasing the size of the metal backing around the soldering pad. Refer to the product datasheet for specific design recommendations regarding heat dissipation.

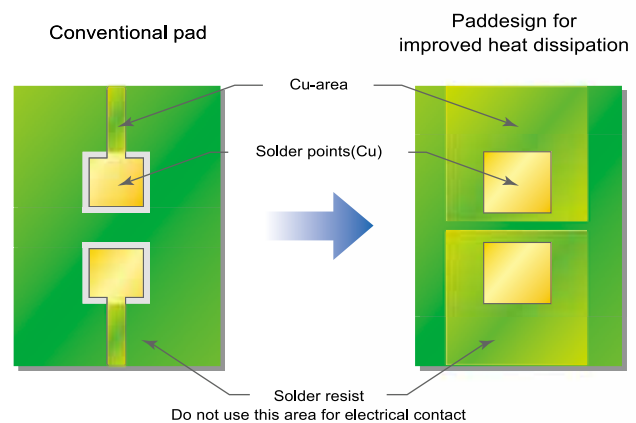

6. High temperatures can reduce device performance and reliability. Keep LED devices away from heat sources for best performance.

Restrictions on Product Use

1. The information contained within this document is subject to change without notice. Before referencing this document, please confirm that it is the most current version available.
2. Not all devices and product families are available in every country.
3. The light output from UV, blue, white, and other high-power LEDs may cause injury to the human eye when viewed directly.
4. LED devices may contain gallium arsenide (GaAs) material. GaAs is harmful if ingested. GaAs dust and fumes are toxic. Do not break, cut, or pulverize LED devices. Do not dissolve LEDs in chemical solvents.
5. Semiconductor devices can fail or malfunction due to their sensitivity to electrical fluctuation and physical stress. It is the responsibility of the user to observe all safety standards when using Kingbright products, in order to avoid situations in which the malfunction or failure of a Kingbright product could cause injury, property damage, or the loss of human life. In developing designs, please insure that Kingbright products are used within specified operating conditions as set forth in the most recent product specification datasheet.

White Bin Code

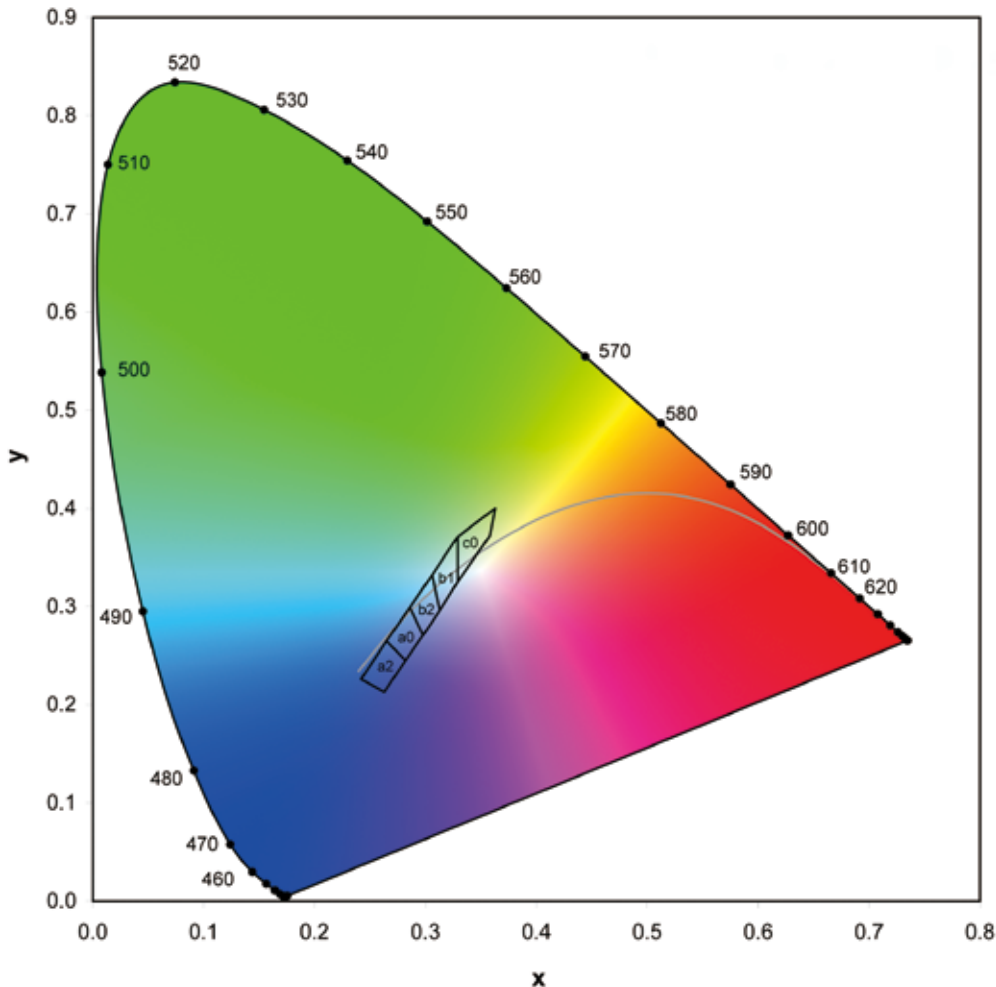

Bin	x	y
a2	0.263	0.213
	0.282	0.245
	0.265	0.265
	0.242	0.226
CCT: 15000K~		
a0	0.282	0.245
	0.298	0.271
	0.286	0.299
	0.265	0.265
CCT: 9000~15000K		
b2	0.298	0.271
	0.313	0.296
	0.306	0.332
	0.286	0.299
CCT: 6800~9000K		
b1	0.313	0.296
	0.329	0.325
	0.329	0.371
	0.306	0.332
CCT: 5600~6800K		
c0	0.329	0.325
	0.358	0.372
	0.363	0.400
	0.329	0.371
CCT: 4600~5600K		

CCT2500 ~ 7000 K Bin Code

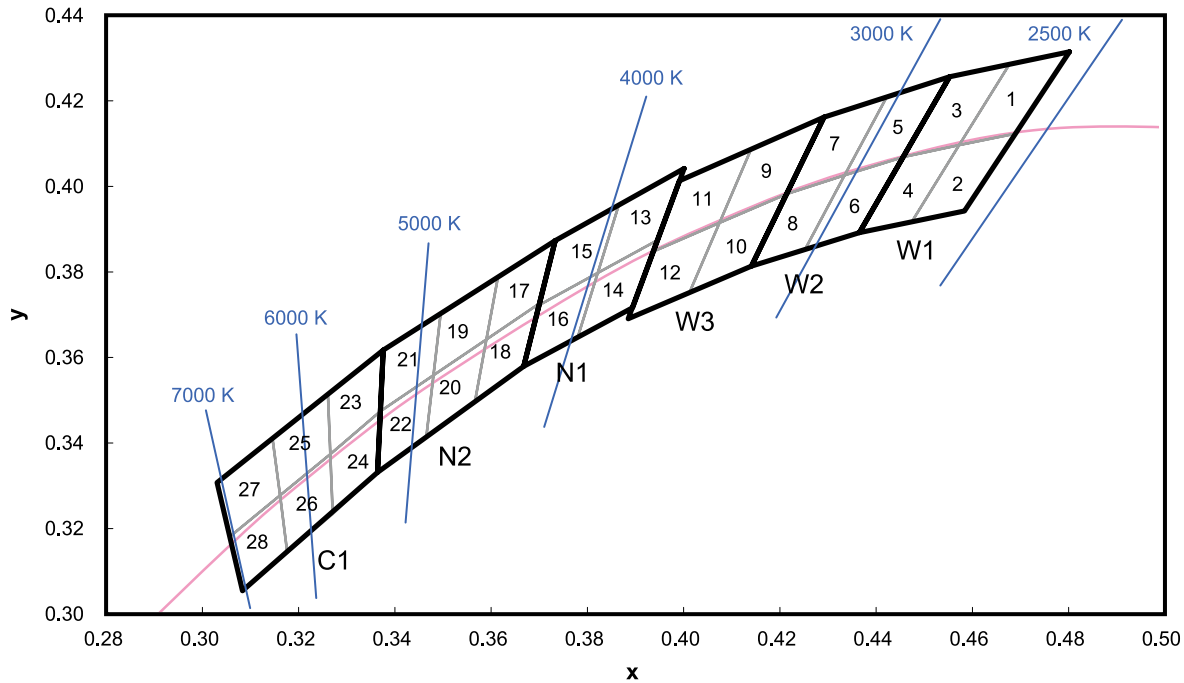

Group	Chromaticity Regions	CCT(K)		
		Min.	Typ.	Max.
W1	1, 2, 3, 4	2580	2700	2870
W2	5, 6, 7, 8	2870	3000	3220
W3	9, 10, 11, 12	3220	3500	3710
N1	13, 14, 15, 16	3710	4000	4260
N2	17, 18, 19, 20, 21, 22	4260	4700	5310
C1	23, 24, 25, 26, 27, 28	5310	6000	7040

	x	y	x	y	x	y	x	y			
1	0.4582	0.4099	8	0.4147	0.3814	15	0.3702	0.3722	22	0.3481	0.3557
	0.4687	0.4289		0.4221	0.3984		0.3736	0.3874		0.3370	0.3472
	0.4813	0.4319		0.4342	0.4028		0.3869	0.3958		0.3361	0.3328
	0.4700	0.4126		0.4259	0.3853		0.3825	0.3798		0.3466	0.3411
2	0.4483	0.3919	9	0.4080	0.3916	16	0.3670	0.3578	23	0.3376	0.3616
	0.4582	0.4099		0.4146	0.4089		0.3702	0.3722		0.3260	0.3512
	0.4700	0.4126		0.4299	0.4165		0.3825	0.3798		0.3265	0.3371
	0.4593	0.3944		0.4221	0.3984		0.3783	0.3646		0.3370	0.3472
3	0.4465	0.4071	10	0.4017	0.3751	17	0.3736	0.3874	24	0.3370	0.3472
	0.4562	0.4260		0.4080	0.3916		0.3616	0.3788		0.3265	0.3371
	0.4687	0.4289		0.4221	0.3984		0.3592	0.3641		0.3270	0.3230
	0.4582	0.4099		0.4147	0.3814		0.3703	0.3726		0.3364	0.3328
4	0.4373	0.3893	11	0.3941	0.3848	18	0.3703	0.3726	25	0.3260	0.3512
	0.4465	0.4071		0.3996	0.4015		0.3592	0.3641		0.3144	0.3408
	0.4582	0.4099		0.4146	0.4089		0.3568	0.3495		0.3160	0.3274
	0.4483	0.3919		0.4080	0.3916		0.3670	0.3578		0.3265	0.3371
5	0.4342	0.4028	12	0.3889	0.3690	19	0.3616	0.3788	26	0.3265	0.3371
	0.4430	0.4212		0.3941	0.3848		0.3496	0.3702		0.3160	0.3274
	0.4562	0.4260		0.4080	0.3916		0.3481	0.3557		0.3175	0.3139
	0.4465	0.4071		0.4017	0.3751		0.3592	0.3641		0.3270	0.3230
6	0.4259	0.3853	13	0.3825	0.3798	20	0.3592	0.3641	27	0.3144	0.3408
	0.4342	0.4028		0.3869	0.3958		0.3481	0.3557		0.3028	0.3304
	0.4465	0.4071		0.4006	0.4044		0.3466	0.3411		0.3055	0.3177
	0.4373	0.3893		0.3950	0.3875		0.3568	0.3495		0.3160	0.3274
7	0.4221	0.3984	14	0.3783	0.3646	21	0.3496	0.3702	28	0.3160	0.3274
	0.4299	0.4165		0.3825	0.3798		0.3376	0.3616		0.3055	0.3177
	0.4430	0.4212		0.3950	0.3875		0.3370	0.3472		0.3081	0.3049
	0.4342	0.4028		0.3898	0.3716		0.3481	0.3557		0.3175	0.3139